

RONDA-REC-90

~80°+80° rectangular beam with holder A compatible with 3rd party connectors from TE, Bender+Wirth and IDEAL

SPECIFICATION:

Dimensions	Ø 69.9 mm
Height	14.6 mm
Fastening	socket
ROHS compliant	yes ⓘ



MATERIALS:

Component	Type	Material	Colour	Finish
F15788_RONDA-REC-90	Single lens	PMMA	clear	
F15155_RONDA-HLD-A	Holder	PC	white	

ORDERING INFORMATION:

Quantities for one set:

Single lens	1
Holder	1

Component		Qty in box	MOQ	MPQ	Box weight (kg)
F15788_RONDA-REC-90	Single lens	420	120	30	6.5
» Box size: 480 x 280 x 300 mm					
F15155_RONDA-HLD-A	Holder	420	120	30	4.4
» Box size: 480 x 280 x 300 mm					

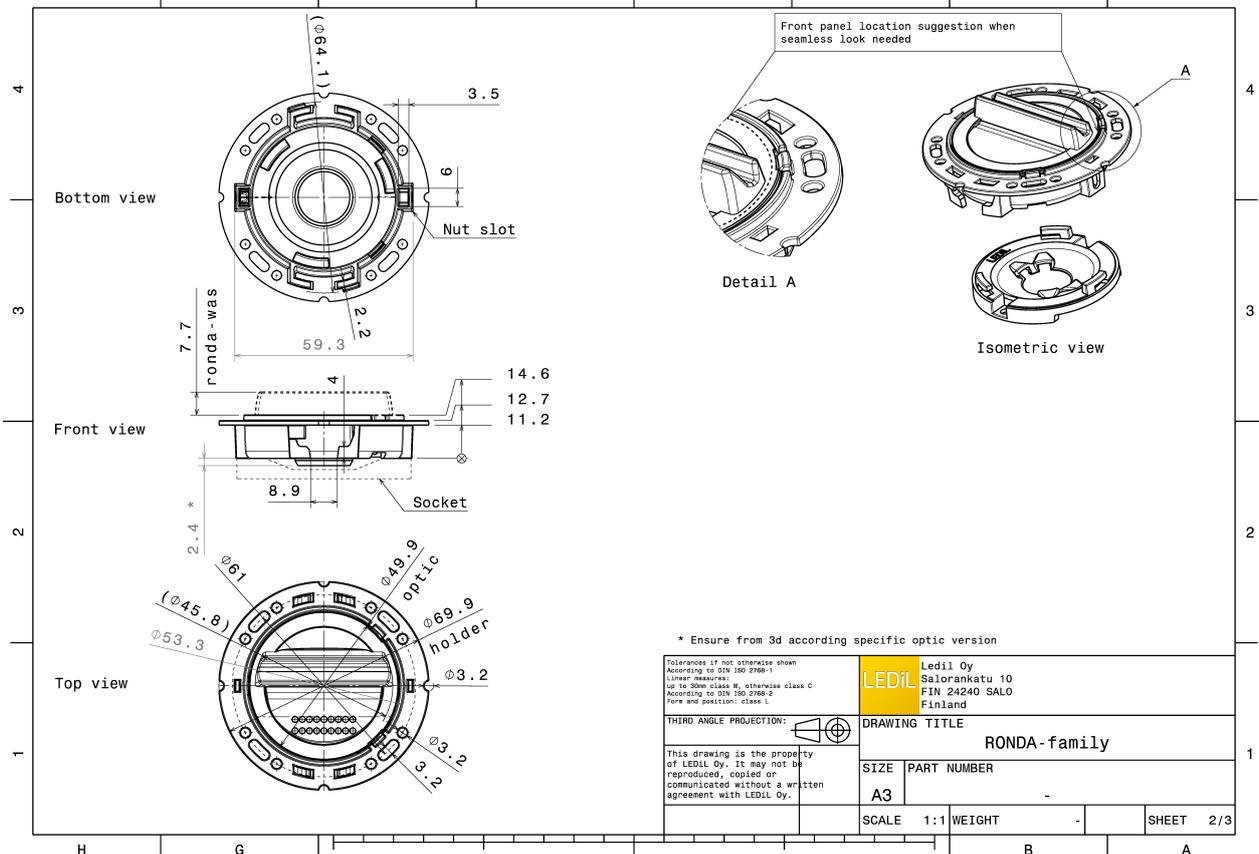
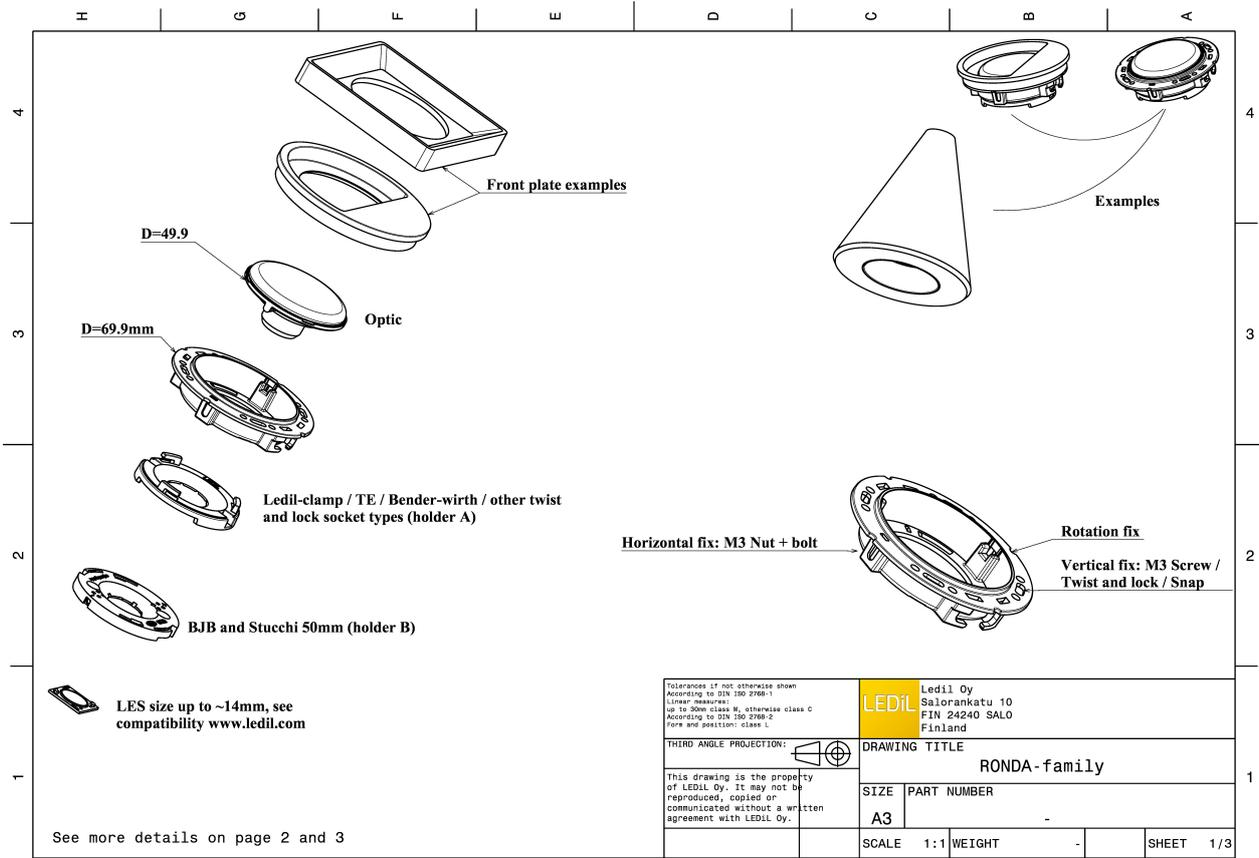

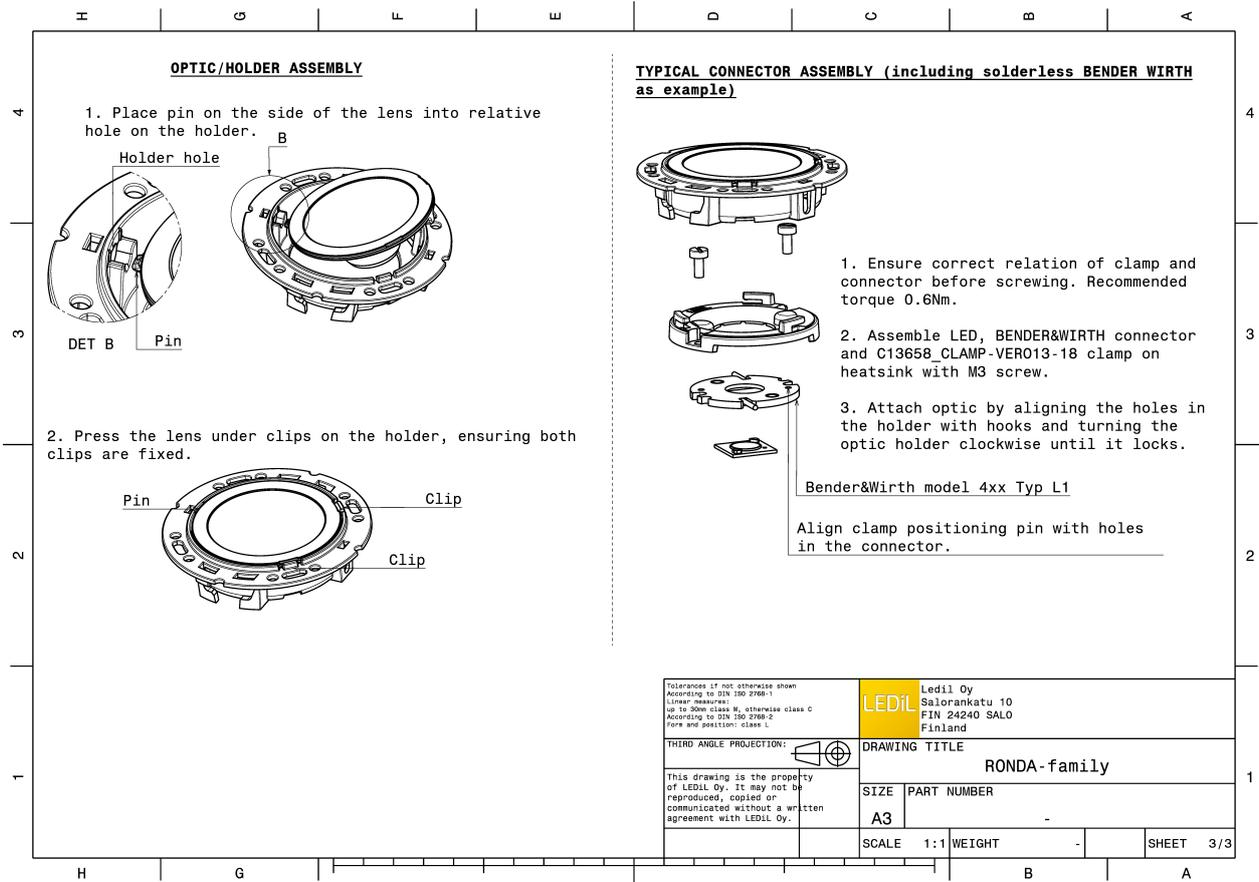

See also our general installation guide: www.ledil.com/installation_guide

OPTICAL RESULTS (MEASURED):

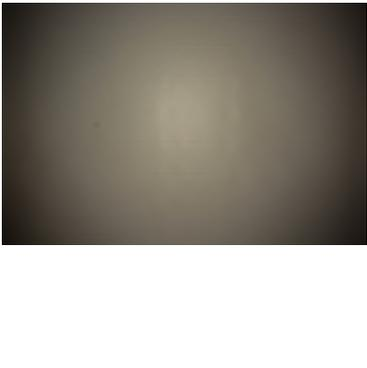
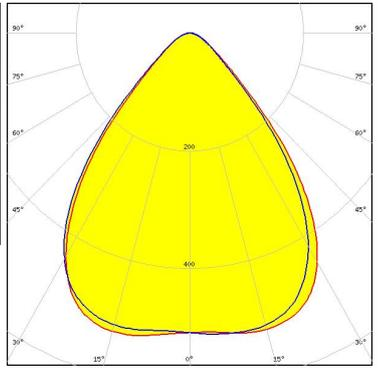
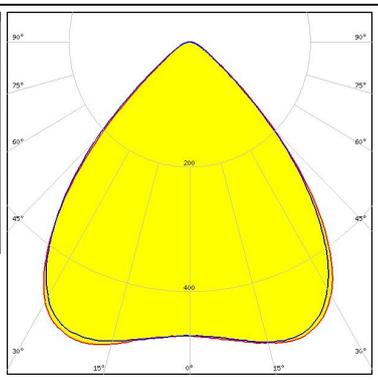
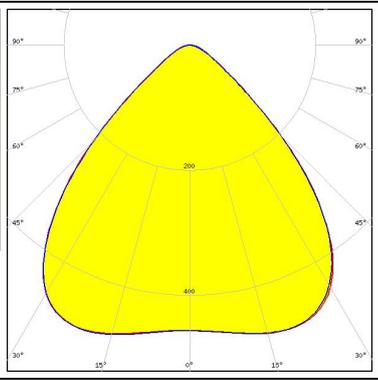
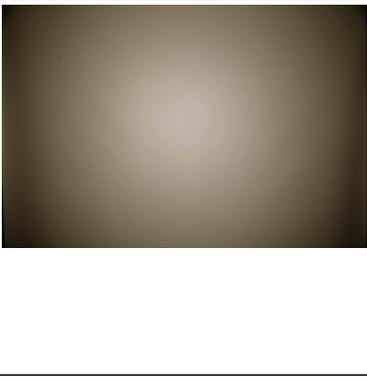
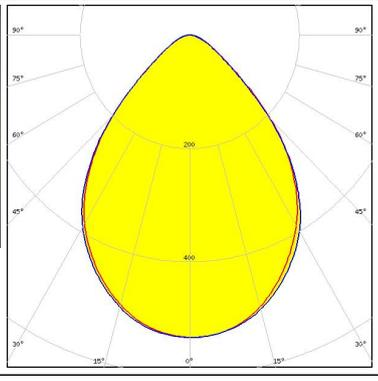
<p></p> <p>LED V13 Gen7 FWHM / FWTM 80.0° / 112.0° Efficiency 87 % Peak intensity 0.5 cd/lm LEDs/each optic 1 Light colour White Required components: TE Connectivity: 2213254-2 + OPTIC CLIP Z50 TYPE1 2213194-1</p>		
<p></p> <p>LED Vero SE 13 FWHM / FWTM 87.0° / 113.0° Efficiency 91 % Peak intensity 0.5 cd/lm LEDs/each optic 1 Light colour White Required components: C16402_CLAMP-VEROSE-13-18</p>		
<p></p> <p>LED VERO13 FWHM / FWTM 88.0° / 118.0° Efficiency 91 % Peak intensity 0.5 cd/lm LEDs/each optic 1 Light colour White Required components: C13658_CLAMP-VERO13-18</p>		
<p></p> <p>LED VERO18 FWHM / FWTM 81.0° / 120.0° Efficiency 89 % Peak intensity 0.5 cd/lm LEDs/each optic 1 Light colour White Required components: C13658_CLAMP-VERO13-18</p>		

OPTICAL RESULTS (MEASURED):

CITIZEN

LED CLL03x/CLU03x
 FWHM / FWTM 78.0° / 110.0°
 Efficiency 89 %
 Peak intensity 0.6 cd/lm
 LEDs/each optic 1
 Light colour White
 Required components:
 C16791_CLAMP-Z45-A
 TE Connectivity: 2325807-3

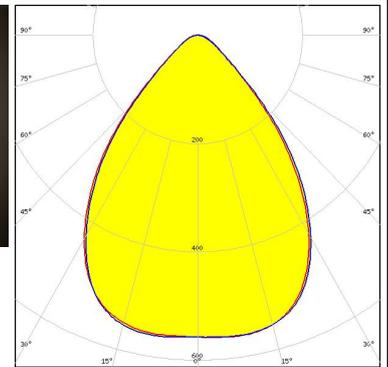

LED CXA/B 15xx
 FWHM / FWTM 87.0° / 119.0°
 Efficiency 91 %
 Peak intensity 0.5 cd/lm
 LEDs/each optic 1
 Light colour White
 Required components:
 C14123_CLAMP-CXA15-18
 Bender Wirth: 434 Typ L1

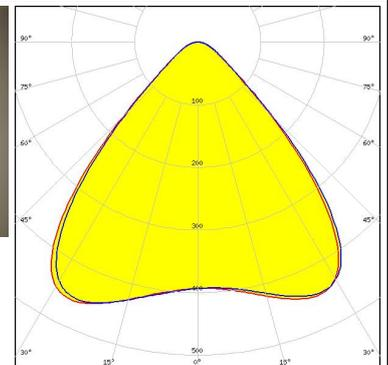

LED CXA/B 1816 & CXA/B 1820 & CXA 1850
 FWHM / FWTM 89.0° / 115.0°
 Efficiency 92 %
 Peak intensity 0.5 cd/lm
 LEDs/each optic 1
 Light colour White
 Required components:
 C14123_CLAMP-CXA15-18

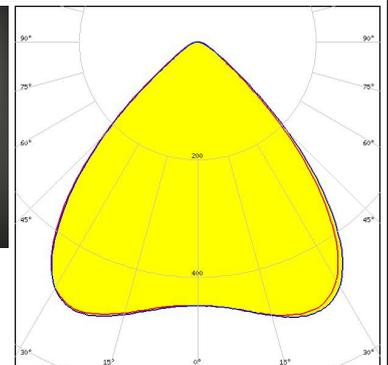
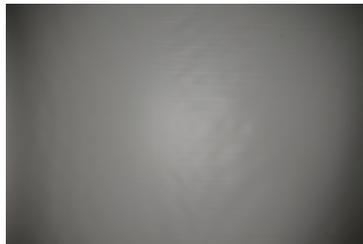

LED CXA/B 1816 & CXA/B 1820 & CXA 1850
 FWHM / FWTM 84.0° / 115.0°
 Efficiency 88 %
 Peak intensity 0.5 cd/lm
 LEDs/each optic 1
 Light colour White
 Required components:
 TE Connectivity: 2213401-2 + OPTIC CLIP Z50 TYPE1 2213194-1

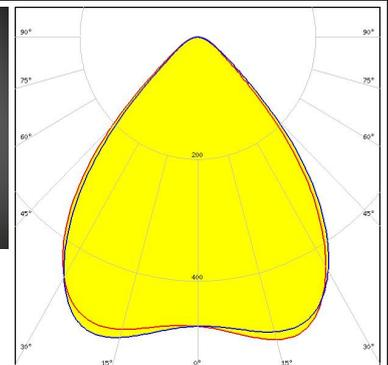
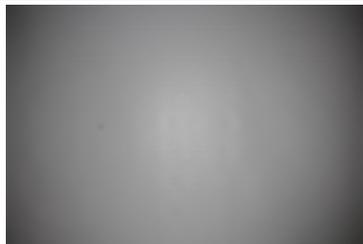

OPTICAL RESULTS (MEASURED):

OSRAM

LED PrevaLED Core G7 L15 H1
 FWHM / FWTM 67.0° / 103.0°
 Efficiency 81 %
 Peak intensity 0.6 cd/lm
 LEDs/each optic 1
 Light colour White
 Required components:
 C16685_CLAMP-PRV-A

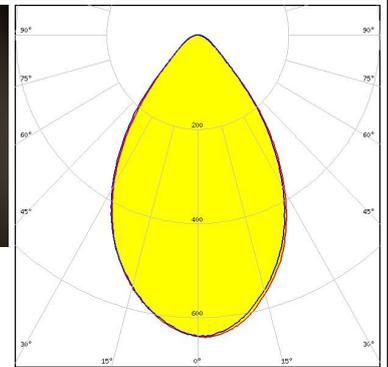

PHILIPS

LED Fortimo SLM L13 CoB
 FWHM / FWTM 82.0° / 113.0°
 Efficiency 86 %
 Peak intensity 0.5 cd/lm
 LEDs/each optic 1
 Light colour White
 Required components:
 TE Connectivity: 2213130-2 + OPTIC CLIP Z50 TYPE1 2213194-1

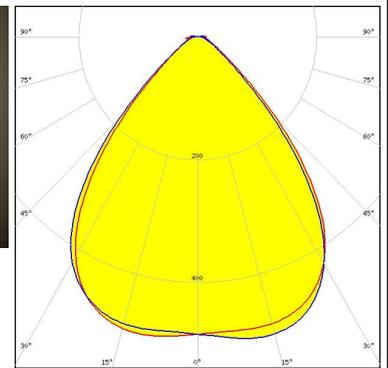

PHILIPS

LED Fortimo SLM L15 + SLM holder
 FWHM / FWTM 77.0° / 111.0°
 Efficiency 86 %
 Peak intensity 0.6 cd/lm
 LEDs/each optic 1
 Light colour White
 Required components:
 TE Connectivity: OPTIC CLIP Z50 TYPE1 2213194-1

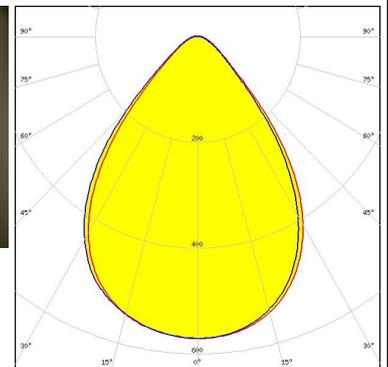

SEOL SEMICONDUCTOR
 LED MJT COB LES 14.5
 FWHM / FWTM 78.0° / 112.0°
 Efficiency 87 %
 Peak intensity 0.5 cd/lm
 LEDs/each optic 1
 Light colour White
 Required components:
 TE Connectivity: 2213254-2 + OPTIC CLIP Z50 TYPE1 2213194-1

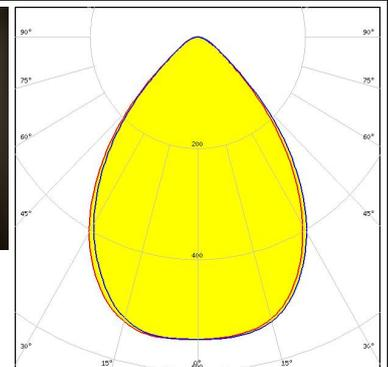
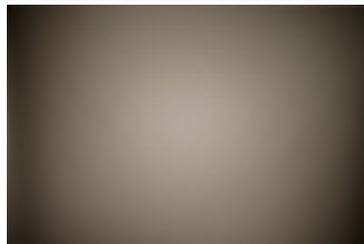

OPTICAL RESULTS (SIMULATED):

bridgelux.

LED V13 Gen7
 FWHM / FWTM 70.0° / 94.0°
 Efficiency 85 %
 Peak intensity 0.7 cd/lm
 LEDs/each optic 1
 Light colour White
 Required components:
 IDEAL: 50-2103CT + 50-2100AN

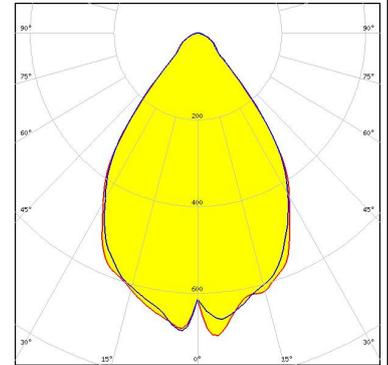

bridgelux.

LED V13 Gen7
 FWHM / FWTM 86.0 + 75.0° / 100.0 + 94.0°
 Efficiency 79 %
 Peak intensity 0.5 cd/lm
 LEDs/each optic 1
 Light colour White
 Required components:
 Bender Wirth: 477 Typ L1

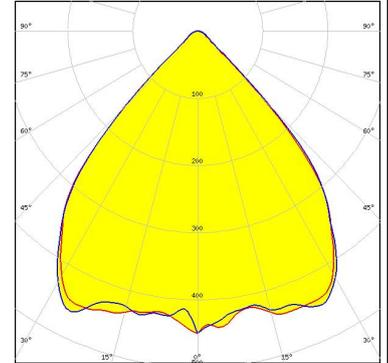

CREE
LEDs

LED CXA/B 1830
 FWHM / FWTM 90.0°
 Efficiency 90 %
 LEDs/each optic 1
 Light colour White
 Required components:
 C14123_CLAMP-CXA15-18

GENERAL INFORMATION:

NOTE: The typical beam angle will be changed by different color, chip size and chip position tolerance. The typical total beam angle is the full angle measured where the luminous intensity is half of the peak value.

Due to use of high power COB's with this product, special attention to proper thermal design is highly recommended. LEDiL has no liability for direct, indirect or consecutive damages arising from the LEDiL products being used outside of the recommended temperature range.

MATERIALS:

As part of our continuous research and improvement processes, and to ensure the best possible quality and availability of our products, LEDiL reserves the right to change material grades without notice.

PRODUCT DATA USER AGREEMENT AND DISCLAIMER:

The measured data in the provided downloadable LEDiL Product Datasheets and Mechanical 2D-Drawings is rounded and provided as reference for planning. LEDiL Oy's optical specifications have been verified by conducting performance testing of the products in accordance with the company's quality system. The reported data are averaged results of multiple measurements with typical variation. LEDiL Oy reserves the right to without prior notification make changes and improvements to its products.

LEDiL Oy assumes neither warranty, nor guarantee nor any other liability of any kind for the contents and correctness of the provided data. The provided data has been generated with highest diligence but the provided data may in reality not represent the complete possible variation range of all intrinsic parameters. Therefore, in certain cases a deviation from the provided data could occur.

LEDiL Oy reserves the right to undertake technical changes of its products without further notification which could lead to changes in the provided data. LEDiL Oy assumes no liability of any kind for the possible deviation from any provided data or any other damage resulting from the usage of the provided data.

The user agrees to this disclaimer and user agreement with the download or usage of the provided files.

LEDiL Oy

Joensuunkatu 13
FI-24240 SALO
Finland

LEDiL Inc.

228 West Page Street
Suite D
Sycamore IL 60178
USA

Ledil Optics Technology (Shenzhen) Co., Ltd.

405 , Block B
Casic Motor Building
Shenzhen 518057
P.R.CHINA

Local sales and technical support

[www.ledil.com/
where_to_buy](http://www.ledil.com/where_to_buy)

Shipping locations

Salo, Finland
Hong Kong, China

Distribution Partners

[www.ledil.com/
where_to_buy](http://www.ledil.com/where_to_buy)