

CARMEN-M-C

~35° medium beam. Assembly with holder C compatible with LEDiL HEKLA.

SPECIFICATION:

| | |
|----------------|-----------|
| Dimensions | Ø 69.5 mm |
| Height | 41.5 mm |
| Fastening | socket |
| ROHS compliant | yes ⓘ |

MATERIALS:

| Component | Type | Material | Colour | Finish |
|--------------|-------------|----------|--------|--------|
| CARMEN-M | Single lens | PMMA | clear | |
| CARMEN-HLD-C | Holder | PC | black | |

ORDERING INFORMATION:





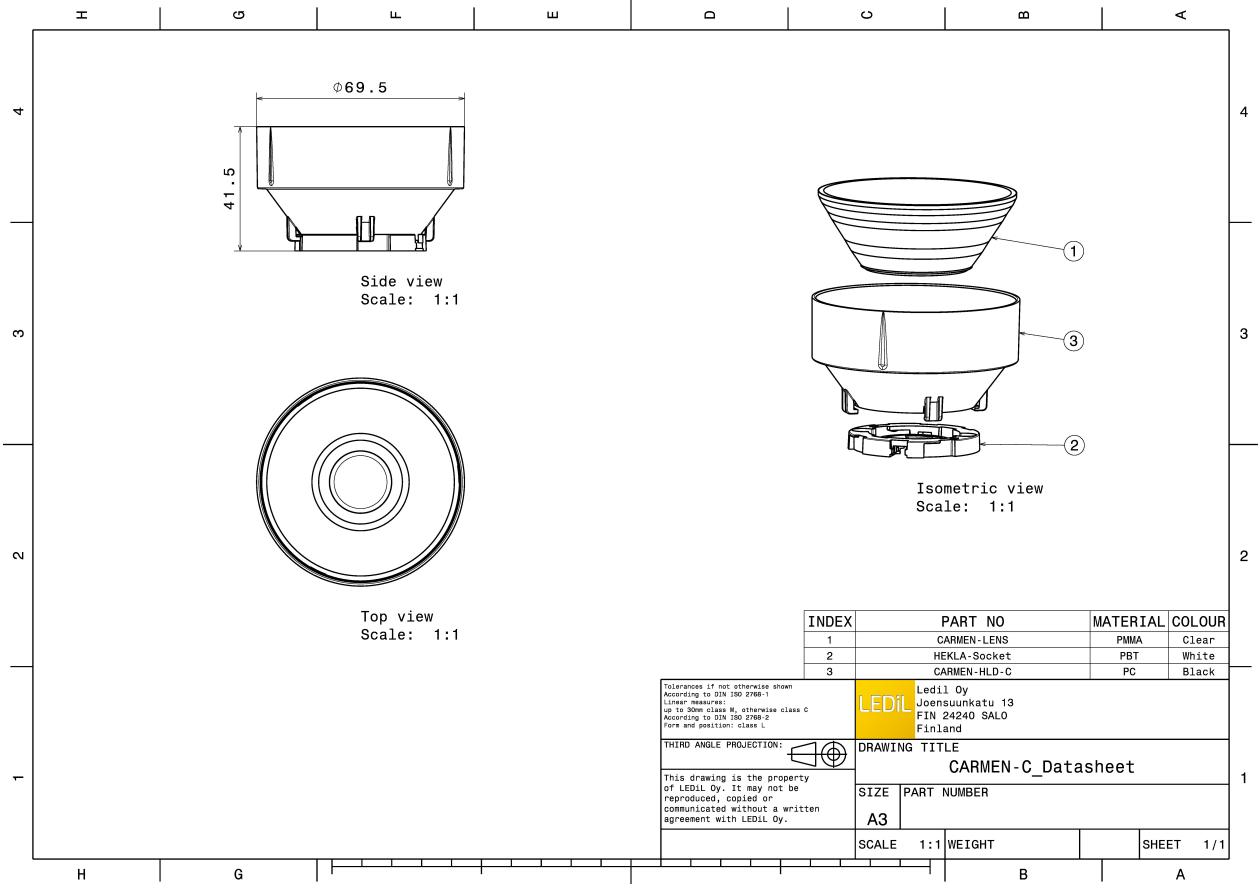



| Component | Type | Qty in box | MOQ | MPQ | Box weight (kg) |
|--|-------------|------------|-----|-----|-----------------|
| CP15775_CARMEN-M-C » Box size: 476 x 273 x 292 mm | Single lens | 150 | 150 | 15 | 4.6 |



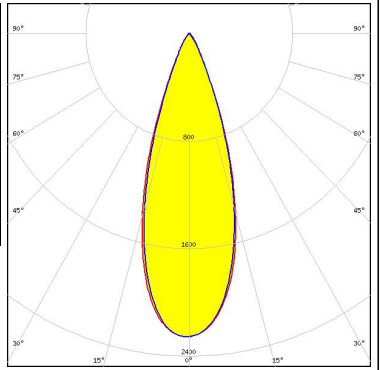

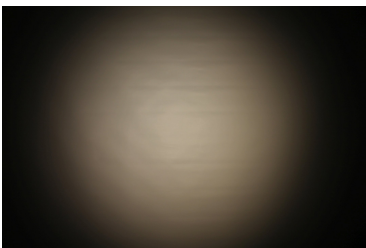
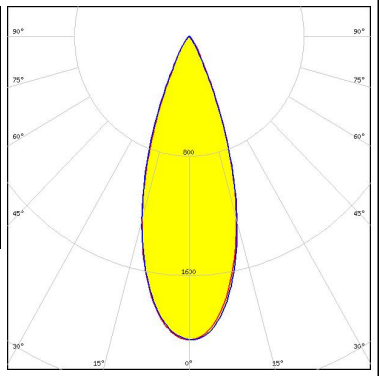

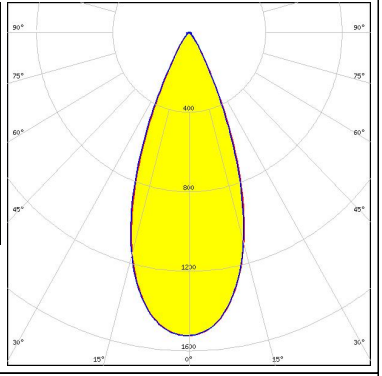

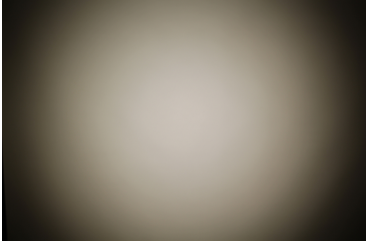
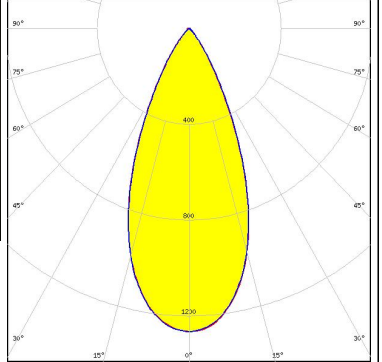

See also our general installation guide: www.ledil.com/installation_guide

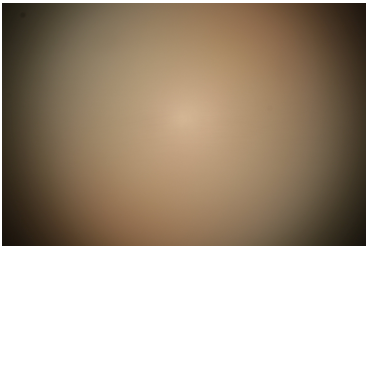
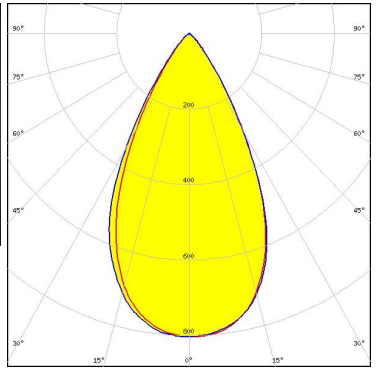

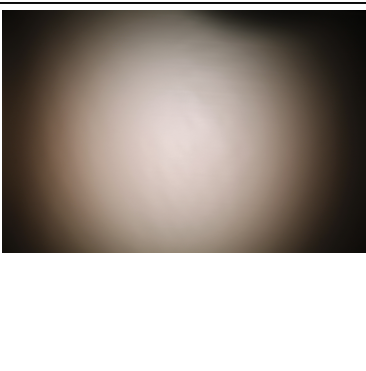
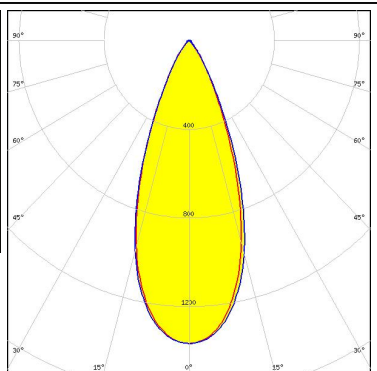

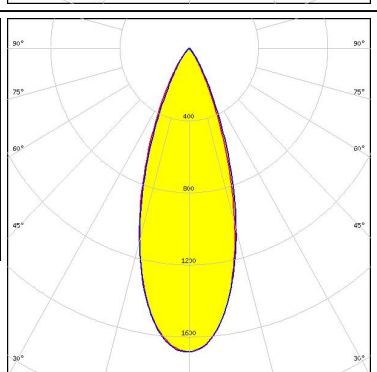

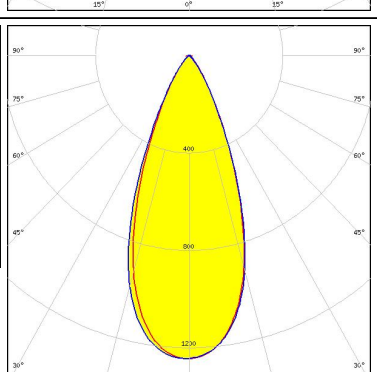

OPTICAL RESULTS (MEASURED):

| | | |
|---|--|---|
| <p></p> <p>LED V4 HD Gen 7 FWHM / FWTM 34.0° / 55.0° Efficiency 82 % Peak intensity 2.3 cd/lm LEDs/each optic 1 Light colour White Required components: F15253_HEKLA-SOCKET-A</p> |  |  |
| <p></p> <p>LED V6 HD Gen 7 FWHM / FWTM 36.0° / 58.0° Efficiency 79 % Peak intensity 2 cd/lm LEDs/each optic 1 Light colour White Required components: F15255_HEKLA-SOCKET-C</p> |  |  |
| <p></p> <p>LED V9 HD Gen7 FWHM / FWTM 41.0° / 63.0° Efficiency 74 % Peak intensity 1.5 cd/lm LEDs/each optic 1 Light colour White Required components: F15859_HEKLA-SOCKET-I</p> |  |  |
| <p></p> <p>LED VERO10 FWHM / FWTM 45.0° / 72.0° Efficiency 74 % Peak intensity 1.2 cd/lm LEDs/each optic 1 Light colour White Required components: F15616_HEKLA-SOCKET-F</p> |  |  |

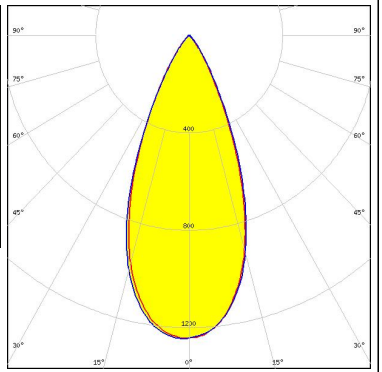
OPTICAL RESULTS (MEASURED):

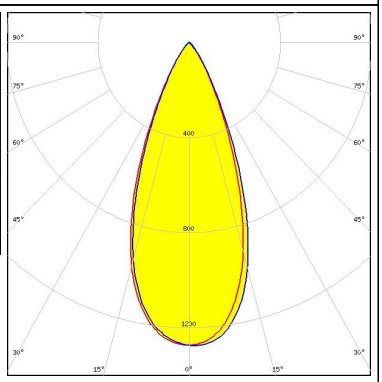
| | | |
|---|--|---|
| <p></p> <p>LED Vesta DTW 13mm (21W) FWHM / FWTM 55.0° / 80.0° Efficiency 64 % Peak intensity 0.8 cd/lm LEDs/each optic 1 Light colour Tunable White</p> <p>Required components: C16142_HEKLA-SOCKET-K Bender Wirth: 491 Typ L8</p> |  |  |
| <p></p> <p>LED Vesta DTW 9mm (4W/6W/12W) FWHM / FWTM 40.0° / 67.0° Efficiency 67 % Peak intensity 1.4 cd/lm LEDs/each optic 1 Light colour White</p> <p>Required components: C16142_HEKLA-SOCKET-K Bender Wirth: 490 Typ L8</p> |  |  |
| <p></p> <p>LED Vesta TW 6mm DP FWHM / FWTM 37.0° / 63.0° Efficiency 72 % Peak intensity 1.7 cd/lm LEDs/each optic 1 Light colour White</p> <p>Required components: C16142_HEKLA-SOCKET-K Bender Wirth: 504 Typ L8</p> |  |  |
| <p></p> <p>LED Vesta TW 9mm (12W) CSP FWHM / FWTM 42.0° / 69.0° Efficiency 66 % Peak intensity 1.2 cd/lm LEDs/each optic 1 Light colour White</p> <p>Required components: C16142_HEKLA-SOCKET-K</p> |  |  |

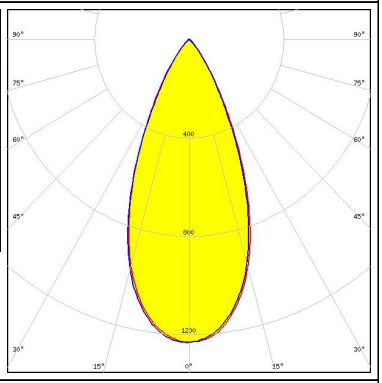
OPTICAL RESULTS (MEASURED):

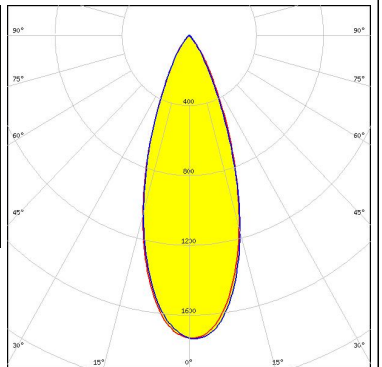
| | | |
|---|--|---|
| <p></p> <p>LED Vesta TW 9mm (9W) DP FWHM / FWTM 43.0° / 69.0° Efficiency 69 % Peak intensity 1.2 cd/lm LEDs/each optic 1 Light colour White Required components: C16142_HEKLA-SOCKET-K Bender Wirth: 489 Typ L8</p> |  |  |
| <p>CITIZEN</p> <p>LED CLC020 Series (Dim-To-Warm) FWHM / FWTM 42.0° / 68.0° Efficiency 66 % Peak intensity 1.3 cd/lm LEDs/each optic 1 Light colour White Required components: C16142_HEKLA-SOCKET-K</p> |  |  |
| <p>CITIZEN</p> <p>LED CLL02x/CLU02x (LES10) FWHM / FWTM 45.0° / 73.0° Efficiency 73 % Peak intensity 1.2 cd/lm LEDs/each optic 1 Light colour White Required components: F15255_HEKLA-SOCKET-C</p> |  |  |
| <p>CITIZEN</p> <p>LED CLU700/701/702/703 FWHM / FWTM 37.0° / 66.0° Efficiency 76 % Peak intensity 1.7 cd/lm LEDs/each optic 1 Light colour White Required components: F15255_HEKLA-SOCKET-C</p> |  |  |

OPTICAL RESULTS (MEASURED):

CITIZEN

LED CLU710/711
 FWHM / FWTM 41.0° / 68.0°
 Efficiency 73 %
 Peak intensity 1.4 cd/lm
 LEDs/each optic 1
 Light colour White
 Required components:
 F15859_HEKLA-SOCKET-I

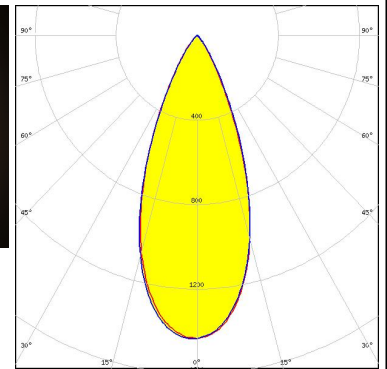
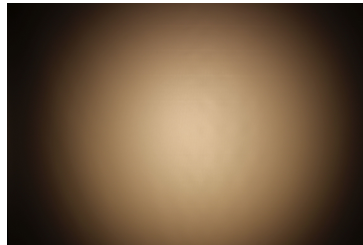

CITIZEN

LED CLU7A2/7A3
 FWHM / FWTM 37.0° / 64.0°
 Efficiency 78 %
 Peak intensity 1.8 cd/lm
 LEDs/each optic 1
 Light colour White
 Required components:
 F15255_HEKLA-SOCKET-C

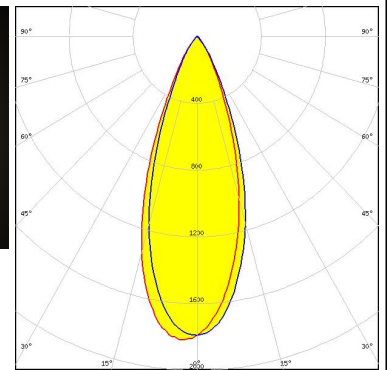
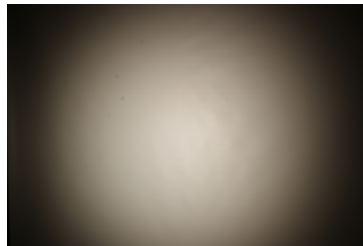

CITIZEN

LED CLU7B2
 FWHM / FWTM 35.0° / 62.0°
 Efficiency 80 %
 Peak intensity 2 cd/lm
 LEDs/each optic 1
 Light colour White
 Required components:
 F15255_HEKLA-SOCKET-C

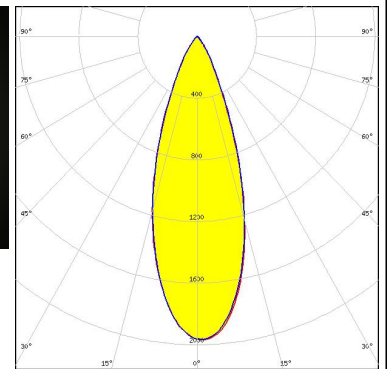
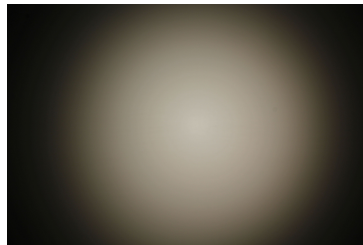

CITIZEN

LED LCN-C01B (Tunable White)
 FWHM / FWTM 41.0° / 69.0°
 Efficiency 66 %
 Peak intensity 1.3 cd/lm
 LEDs/each optic 1
 Light colour White
 Required components:
 C16142_HEKLA-SOCKET-K

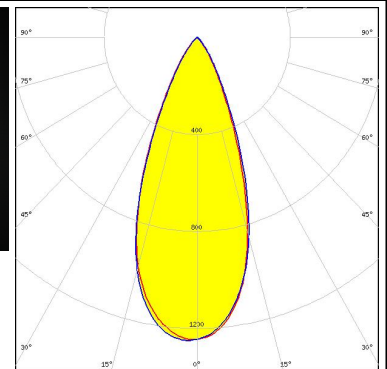
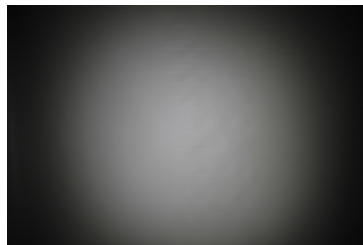

OPTICAL RESULTS (MEASURED):



LED CMA1516
 FWHM / FWTM 45.0° / 68.0°
 Efficiency 77 %
 Peak intensity 1.4 cd/lm
 LEDs/each optic 1
 Light colour White
 Required components:
 F15256_HEKLA-SOCKET-D

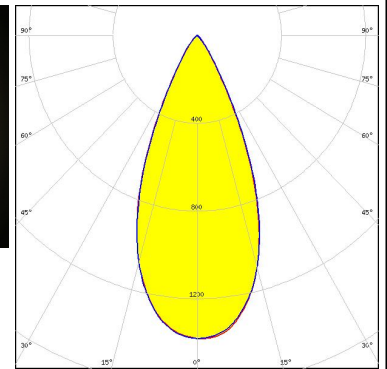
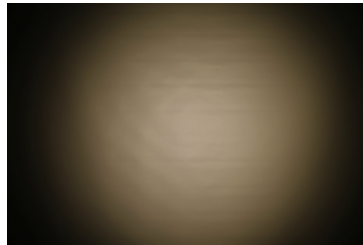

LED LUXEON CX Plus CoB L08 (Gen2)
 FWHM / FWTM 56.0° / 80.0°
 Efficiency 67 %
 Peak intensity 0.8 cd/lm
 LEDs/each optic 1
 Light colour White
 Required components:
 Bender Wirth: 637a Hekla

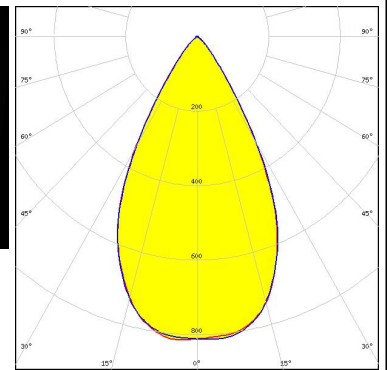
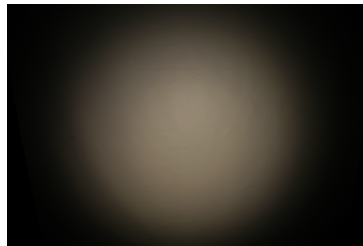

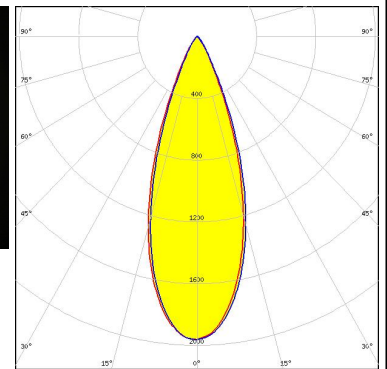
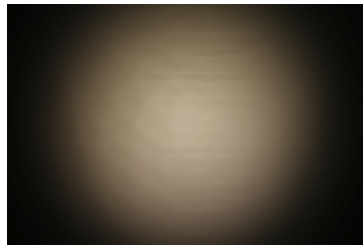

LED LUXEON CoB 1202HD
 FWHM / FWTM 36.0° / 59.0°
 Efficiency 78 %
 Peak intensity 2 cd/lm
 LEDs/each optic 1
 Light colour White
 Required components:
 F15848_HEKLA-SOCKET-G



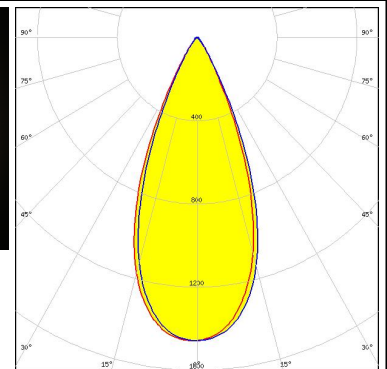
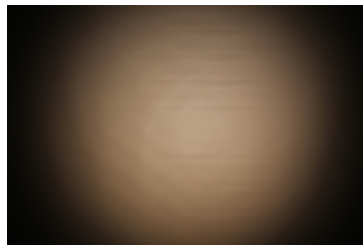

LED LUXEON CoB 1204HD
 FWHM / FWTM 43.0° / 64.0°
 Efficiency 76 %
 Peak intensity 1.5 cd/lm
 LEDs/each optic 1
 Light colour White
 Required components:
 F15858_HEKLA-SOCKET-H

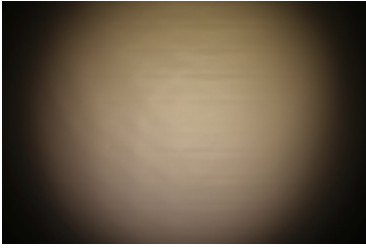
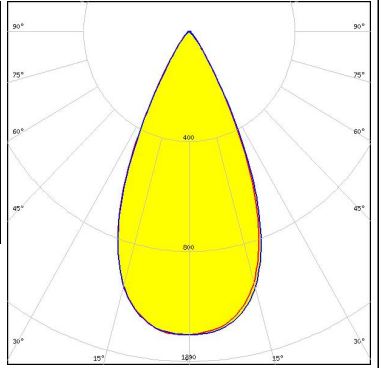

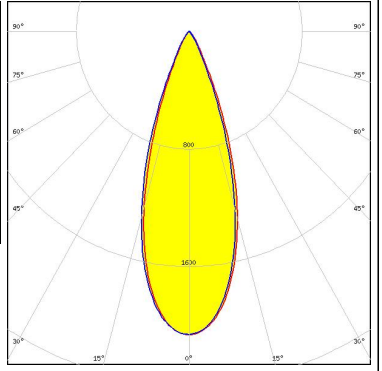
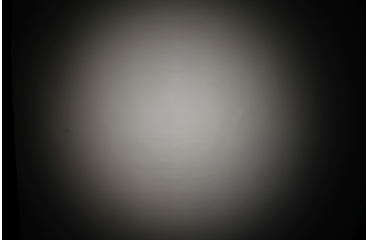
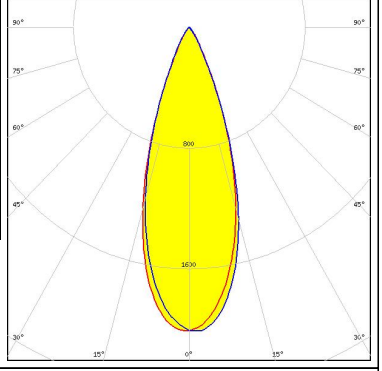
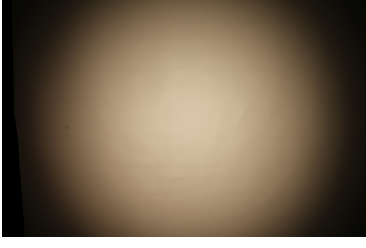
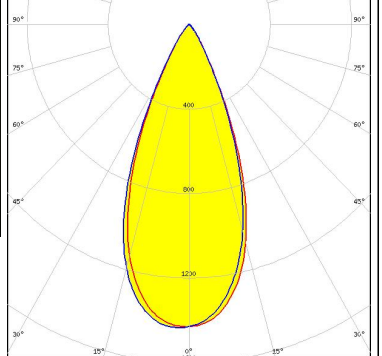

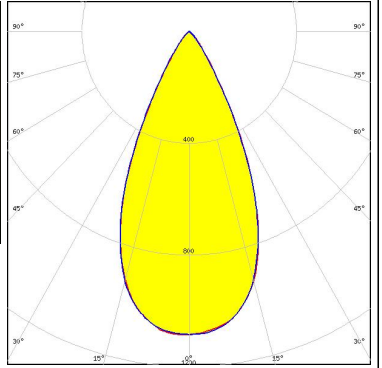
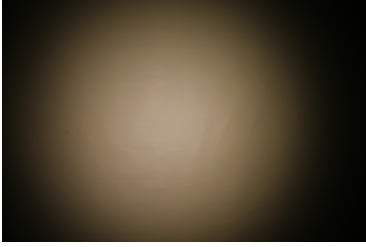
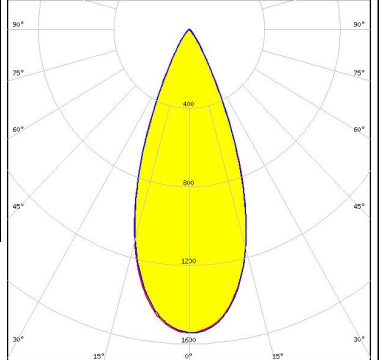

OPTICAL RESULTS (MEASURED):

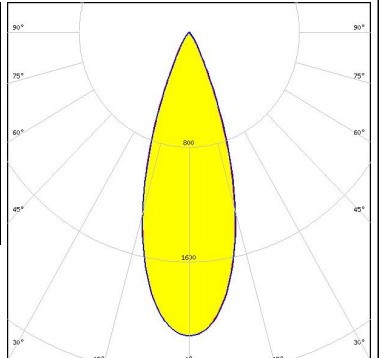
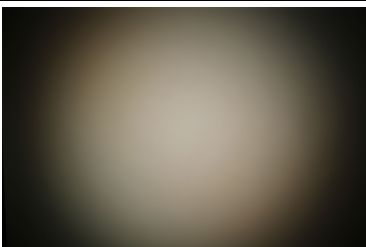
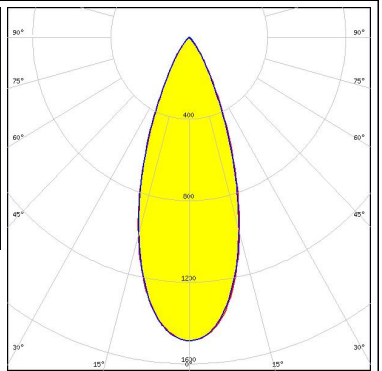
| | | |
|---|--|---|
| <p>LUMILEDS</p> <p>LED LUXEON CoB 1205HD</p> <p>FWHM / FWTM 49.0° / 70.0°</p> <p>Efficiency 71 %</p> <p>Peak intensity 1.1 cd/lm</p> <p>LEDs/each optic 1</p> <p>Light colour White</p> <p>Required components: F15858_HEKLA-SOCKET-H</p> |  |  |
| <p>LUMILEDS</p> <p>LED LUXEON CX Plus CoB - HD S01H4</p> <p>FWHM / FWTM 36.0° / 57.0°</p> <p>Efficiency 78 %</p> <p>Peak intensity 2.1 cd/lm</p> <p>LEDs/each optic 1</p> <p>Light colour White</p> <p>Required components: Bender Wirth: 634c Hekla</p> |  |  |
| <p>LUMILEDS</p> <p>LED LUXEON CX Plus CoB - HD S02H6</p> <p>FWHM / FWTM 35.0° / 57.0°</p> <p>Efficiency 77 %</p> <p>Peak intensity 2 cd/lm</p> <p>LEDs/each optic 1</p> <p>Light colour White</p> <p>Required components: Bender Wirth: 634c Hekla</p> |  |  |
| <p>LUMILEDS</p> <p>LED LUXEON CX Plus CoB - HD S04H9</p> <p>FWHM / FWTM 43.0° / 66.0°</p> <p>Efficiency 75 %</p> <p>Peak intensity 1.4 cd/lm</p> <p>LEDs/each optic 1</p> <p>Light colour White</p> <p>Required components: Bender Wirth: 634c Hekla</p> |  |  |

OPTICAL RESULTS (MEASURED):

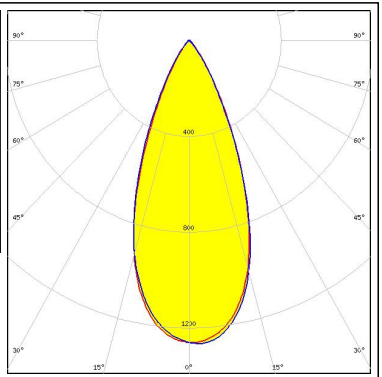
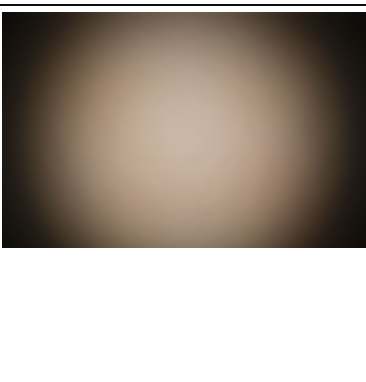
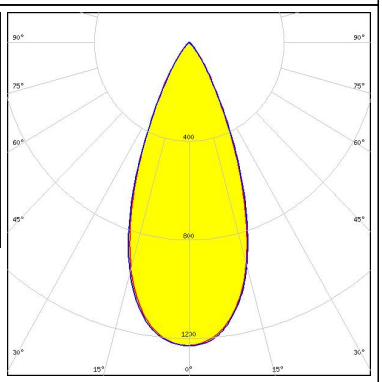
| | | |
|---|--|---|
| <p>LUMILEDS</p> <p>LED LUXEON CX Plus CoB L04 / L05 (Gen2)</p> <p>FWHM / FWTM 49.0° / 72.0°</p> <p>Efficiency 71 %</p> <p>Peak intensity 1.1 cd/m</p> <p>LEDs/each optic 1</p> <p>Light colour White</p> <p>Required components: Bender Wirth: 637a Hekla</p> |  |  |
| <p>LUMILEDS</p> <p>LED LUXEON CX Plus CoB M02 / M03 (Gen2)</p> <p>FWHM / FWTM 41.0° / 63.0°</p> <p>Efficiency 74 %</p> <p>Peak intensity 1.5 cd/m</p> <p>LEDs/each optic 1</p> <p>Light colour White</p> <p>Required components: Bender Wirth: 641a Hekla</p> |  |  |
| <p>LUMILEDS</p> <p>LED LUXEON CX Plus CoB S01 (Gen2)</p> <p>FWHM / FWTM 35.0° / 56.0°</p> <p>Efficiency 78 %</p> <p>Peak intensity 2.1 cd/m</p> <p>LEDs/each optic 1</p> <p>Light colour White</p> <p>Required components: Bender Wirth: 634c Hekla</p> |  |  |
| <p>LUMINUS</p> <p>LED CDM-6 (Dim-To-Warm)</p> <p>FWHM / FWTM 38.0° / 66.0°</p> <p>Efficiency 70 %</p> <p>Peak intensity 1.5 cd/m</p> <p>LEDs/each optic 1</p> <p>Light colour White</p> <p>Required components: C16142_HEKLA-SOCKET-K Bender Wirth: 490 Typ L8</p> |  |  |

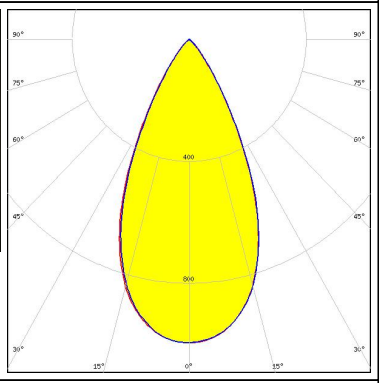
OPTICAL RESULTS (MEASURED):

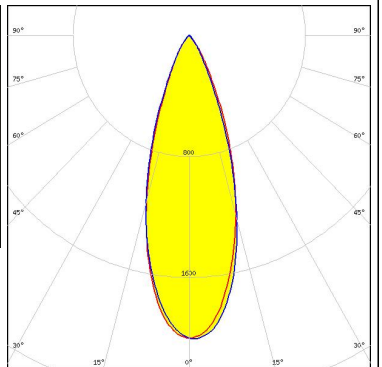
| | | |
|--|--|---|
| <p>LUMINUS</p> <p>LED CDM-9 (Dim-To-Warm)</p> <p>FWHM / FWTM 43.0° / 69.0°</p> <p>Efficiency 68 %</p> <p>Peak intensity 1.3 cd/lm</p> <p>LEDs/each optic 1</p> <p>Light colour White</p> <p>Required components: C16142_HEKLA-SOCKET-K Bender Wirth: 490 Typ L8</p> |  |  |
| <p>LUMINUS</p> <p>LED CTM-9 (Tunable White)</p> <p>FWHM / FWTM 43.0° / 69.0°</p> <p>Efficiency 67 %</p> <p>Peak intensity 1.2 cd/lm</p> <p>LEDs/each optic 1</p> <p>Light colour White</p> <p>Required components: C16142_HEKLA-SOCKET-K Bender Wirth: 495 Typ L8</p> |  |  |
| <p>LUMINUS</p> <p>LED CxM-11 (19x19)</p> <p>FWHM / FWTM 51.0° / 77.0°</p> <p>Efficiency 69 %</p> <p>Peak intensity 1 cd/lm</p> <p>LEDs/each optic 1</p> <p>Light colour White</p> <p>Required components: F15859_HEKLA-SOCKET-I</p> |  |  |
| <p>LUMINUS</p> <p>LED CXM-3</p> <p>FWHM / FWTM 35.0° / 61.0°</p> <p>Efficiency 80 %</p> <p>Peak intensity 2 cd/lm</p> <p>LEDs/each optic 1</p> <p>Light colour White</p> <p>Required components: F15255_HEKLA-SOCKET-C</p> |  |  |

OPTICAL RESULTS (MEASURED):

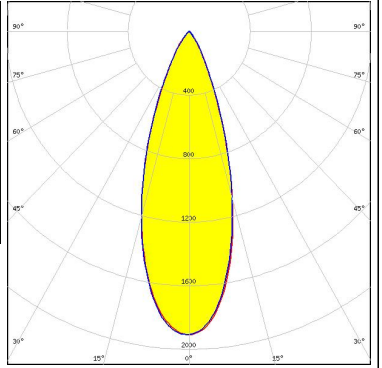
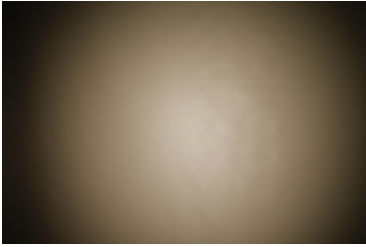
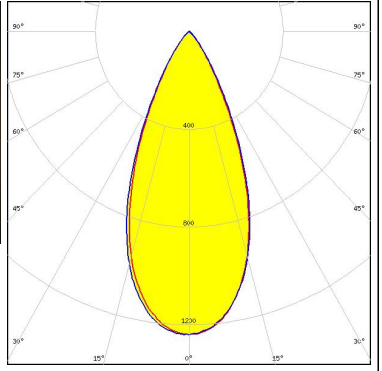
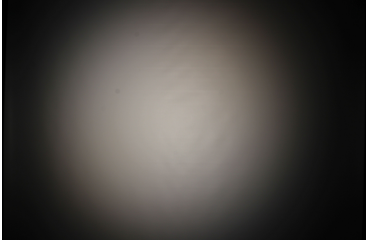
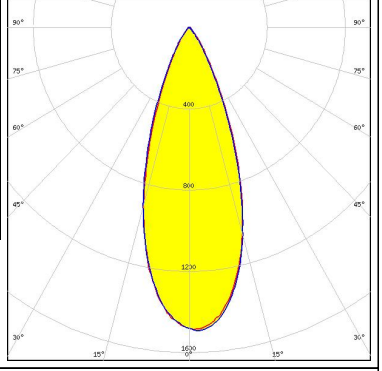
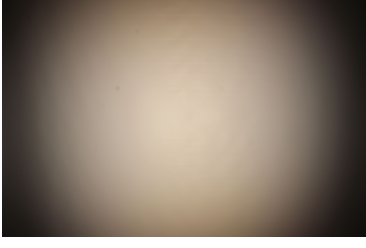
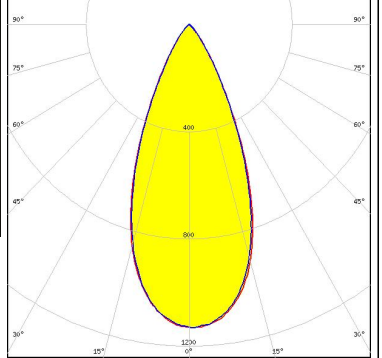
| | | |
|--|--|---|
| <p>LUMINUS</p> <p>LED CXM-4 FWHM / FWTM 35.0° / 62.0° Efficiency 78 % Peak intensity 1.9 cd/lm LEDs/each optic 1 Light colour White Required components: F15255_HEKLA-SOCKET-C</p> |  |  |
| <p>LUMINUS</p> <p>LED CxM-9 (13.5x13.5) FWHM / FWTM 44.0° / 72.0° Efficiency 73 % Peak intensity 1.2 cd/lm LEDs/each optic 1 Light colour White Required components: F15255_HEKLA-SOCKET-C</p> |  |  |
| <p>NICHIA</p> <p>LED NJCWL024Z-V1MT: COB L-Type Tunable White FWHM / FWTM 37.0° / 64.0° Efficiency 67 % Peak intensity 1.5 cd/lm LEDs/each optic 1 Light colour White Required components: C16142_HEKLA-SOCKET-K Bender Wirth: 497 Typ L8</p> |  |  |
| <p>NICHIA</p> <p>LED NVCWJ024Z-V1MT: COB J-Type Tunable White FWHM / FWTM 44.0° / 71.0° Efficiency 66 % Peak intensity 1.1 cd/lm LEDs/each optic 1 Light colour White Required components: C16142_HEKLA-SOCKET-K Bender Wirth: 498 Typ L8</p> |  |  |

OPTICAL RESULTS (MEASURED):

PHILIPS

LED Fortimo SLM L09 CoB
 FWHM / FWTM 44.0° / 66.0°
 Efficiency 75 %
 Peak intensity 1.4 cd/lm
 LEDs/each optic 1
 Light colour White
 Required components:
 F15858_HEKLA-SOCKET-H

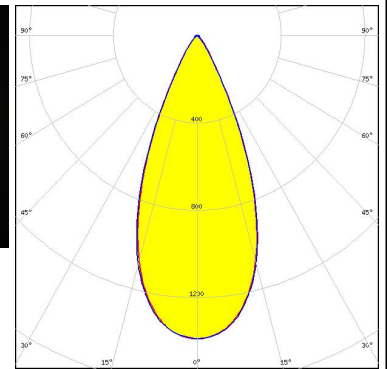
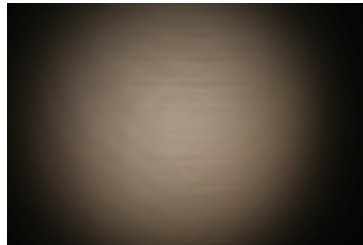

SAMSUNG

LED LC003D / LC006D / LC009D / LC013D
 FWHM / FWTM 45.0° / 73.0°
 Efficiency 74 %
 Peak intensity 1.2 cd/lm
 LEDs/each optic 1
 Light colour White
 Required components:
 F15255_HEKLA-SOCKET-C

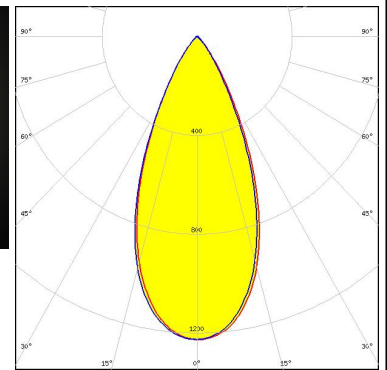
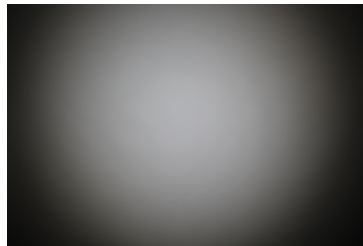

SAMSUNG

LED LC010C G2
 FWHM / FWTM 37.0° / 65.0°
 Efficiency 76 %
 Peak intensity 1.7 cd/lm
 LEDs/each optic 1
 Light colour White
 Required components:
 F15255_HEKLA-SOCKET-C

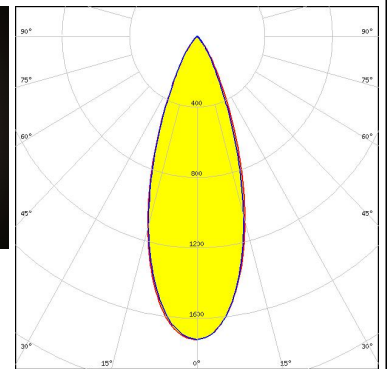
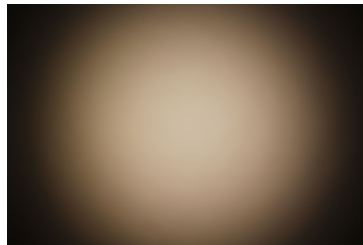

SAMSUNG

LED LC010T (Tunable White)
 FWHM / FWTM 42.0° / 70.0°
 Efficiency 68 %
 Peak intensity 1.3 cd/lm
 LEDs/each optic 1
 Light colour Tunable White
 Required components:
 C16142_HEKLA-SOCKET-K
 Bender Wirth: 501 Typ L8

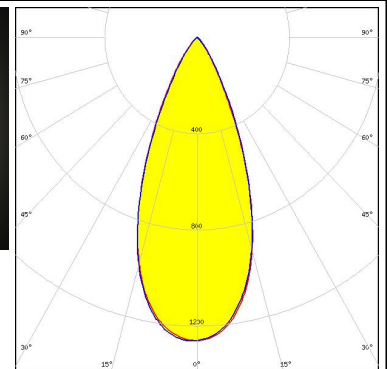
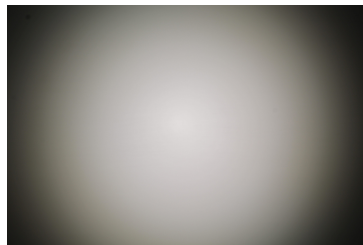

OPTICAL RESULTS (MEASURED):

SAMSUNG

LED LC020C G2
 FWHM / FWTM 43.0° / 70.0°
 Efficiency 72 %
 Peak intensity 1.3 cd/lm
 LEDs/each optic 1
 Light colour White
 Required components:
 F15859_HEKLA-SOCKET-I

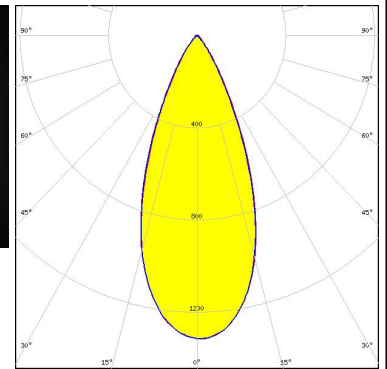

SEOUL SEMICONDUCTOR
 LED MJT COB LES 6
 FWHM / FWTM 37.0° / 64.0°
 Efficiency 74 %
 Peak intensity 1.7 cd/lm
 LEDs/each optic 1
 Light colour White
 Required components:
 F15255_HEKLA-SOCKET-C

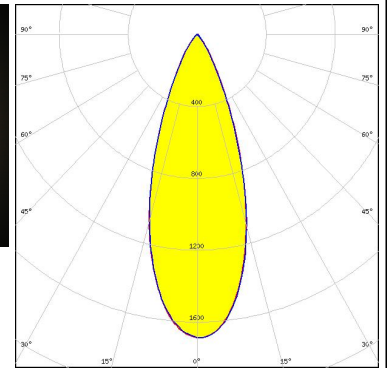
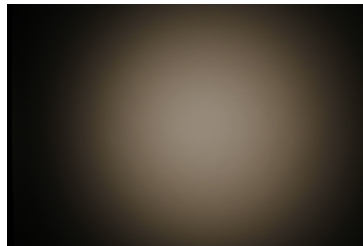

SEOUL SEMICONDUCTOR
 LED MJT COB LES 9.8
 FWHM / FWTM 45.0° / 72.0°
 Efficiency 71 %
 Peak intensity 1.2 cd/lm
 LEDs/each optic 1
 Light colour White
 Required components:
 F15255_HEKLA-SOCKET-C

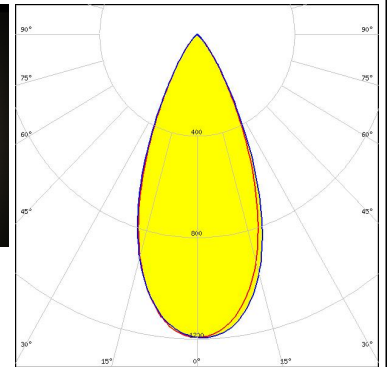
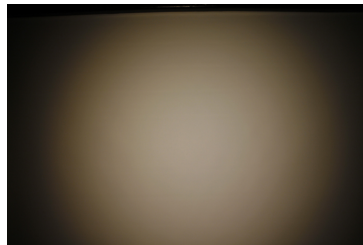

TRIDONIC

LED SLE G7 LES09
 FWHM / FWTM 43.0° / 71.0°
 Efficiency 74 %
 Peak intensity 1.3 cd/lm
 LEDs/each optic 1
 Light colour White
 Required components:
 F15255_HEKLA-SOCKET-C

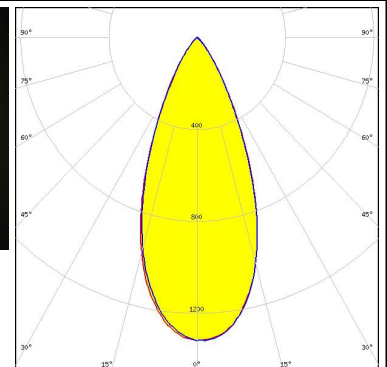
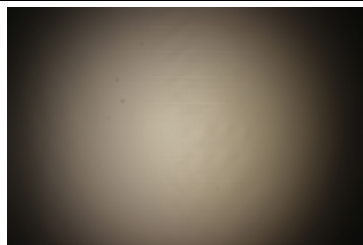

OPTICAL RESULTS (MEASURED):

TRIDONIC

LED SLE G7 LES13
 FWHM / FWTM 54.0° / 79.0°
 Efficiency 66 %
 Peak intensity 0.9 cd/lm
 LEDs/each optic 1
 Light colour White
 Required components:
 F15859_HEKLA-SOCKET-I

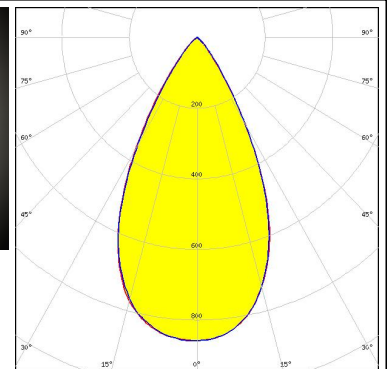
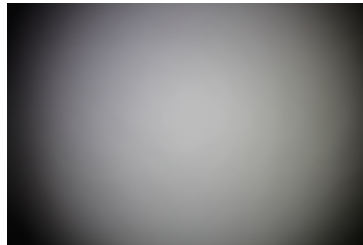

XICATO

LED XOB 6 mm
 FWHM / FWTM 38.0° / 66.0°
 Efficiency 76 %
 Peak intensity 1.7 cd/lm
 LEDs/each optic 1
 Light colour White
 Required components:
 F15255_HEKLA-SOCKET-C

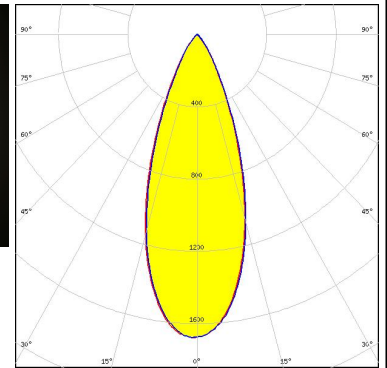
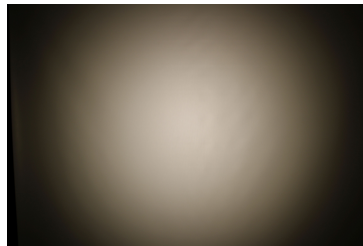

XICATO

LED XOB 9.8 mm
 FWHM / FWTM 43.0° / 72.0°
 Efficiency 74 %
 Peak intensity 1.3 cd/lm
 LEDs/each optic 1
 Light colour White
 Required components:
 F15255_HEKLA-SOCKET-C

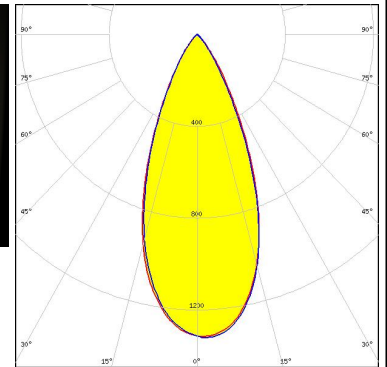
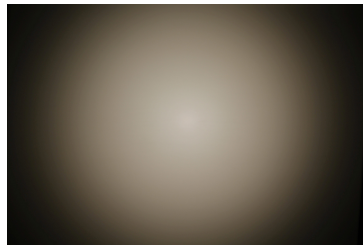

XICATO

LED XTM - 19mm LES
 FWHM / FWTM 58.0° / 88.0°
 Efficiency 61 %
 Peak intensity 0.7 cd/lm
 LEDs/each optic 1
 Light colour White
 Required components:
 C16058_XTM-ADAPTER-50-C

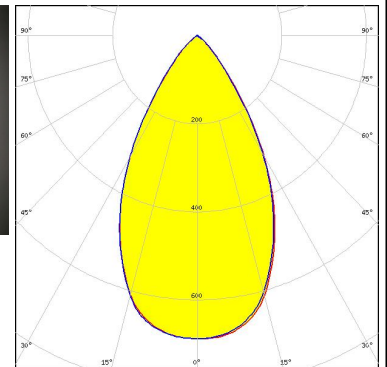
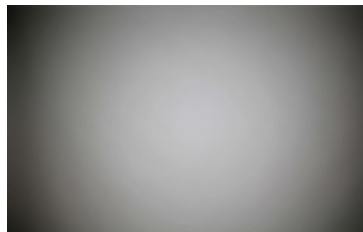

OPTICAL RESULTS (SIMULATED):



LED VERO13
FWHM / FWTM 45.0° / 73.0°
Efficiency 63 %
Peak intensity 1 cd/lm
LEDs/each optic 1
Light colour White
Required components:
 C16142_HEKLA-SOCKET-K



LED CMA1825
FWHM / FWTM 49.0° / 72.0°
Efficiency 70 %
Peak intensity 1.1 cd/lm
LEDs/each optic 1
Light colour White
Required components:

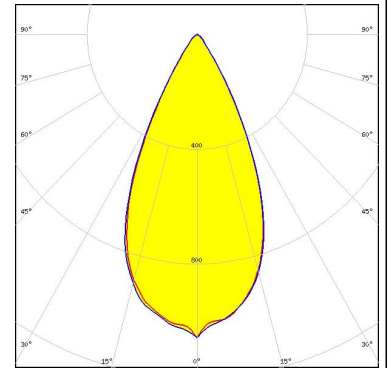

LED CMA1840
FWHM / FWTM 55.0° / 79.0°
Efficiency 66 %
Peak intensity 0.8 cd/lm
LEDs/each optic 1
Light colour White
Required components:

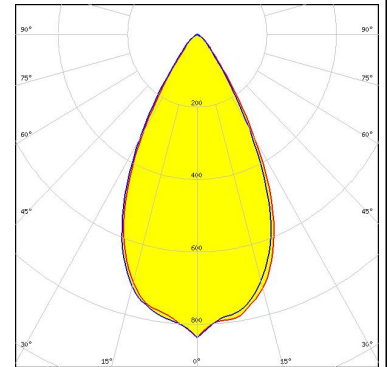

LED CMT14xx
FWHM / FWTM 41.0° / 63.0°
Efficiency 71 %
Peak intensity 1.5 cd/lm
LEDs/each optic 1
Light colour White
Required components:
 F17435_HEKLA-G2-C

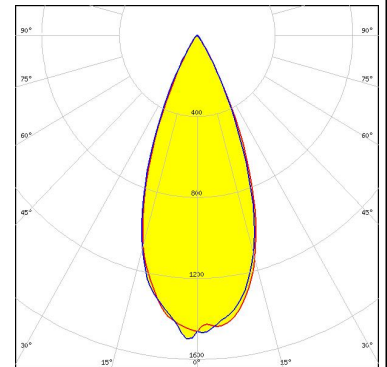

OPTICAL RESULTS (SIMULATED):

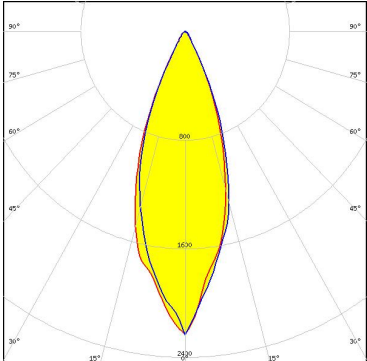
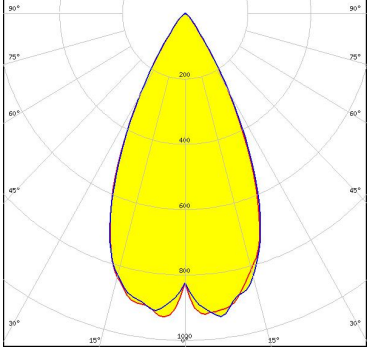
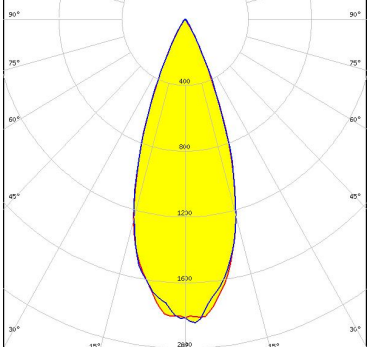
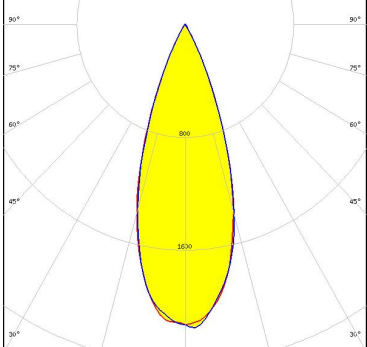
| | |
|---|---|
| <p>CREE LEDs</p> <p>LED CXA/B 15xx FWHM / FWTM 35.8° / 60.0° Efficiency % Peak intensity 2.3 cd/lm LEDs/each optic 1 Light colour White Required components: F15256_HEKLA-SOCKET-D</p> |  |
| <p>CREE LEDs</p> <p>LED CXA/B 1816 & CXA/B 1820 & CXA 1850 FWHM / FWTM 52.0° / 74.0° Efficiency 66 % Peak intensity 1 cd/lm LEDs/each optic 1 Light colour White Required components: F15254_HEKLA-SOCKET-B</p> |  |
| <p>NICHIA</p> <p>LED COB S-Type (LES 7) FWHM / FWTM 38.0° / 58.0° Efficiency 75 % Peak intensity 1.9 cd/lm LEDs/each optic 1 Light colour White Required components: F15848_HEKLA-SOCKET-G</p> |  |
| <p>NICHIA</p> <p>LED COB T-Type FWHM / FWTM 36.0° / 55.0° Efficiency 78 % Peak intensity 2.2 cd/lm LEDs/each optic 1 Light colour White Required components: F15848_HEKLA-SOCKET-G</p> |  |

OPTICAL RESULTS (SIMULATED):

SAMSUNG

LED LC003D / LC006D / LC009D / LC013D
 FWHM / FWTM 45.0° / 67.0°
 Efficiency 69 %
 Peak intensity 1.3 cd/lm
 LEDs/each optic 1
 Light colour White
 Required components:
 F17435_HEKLA-G2-C

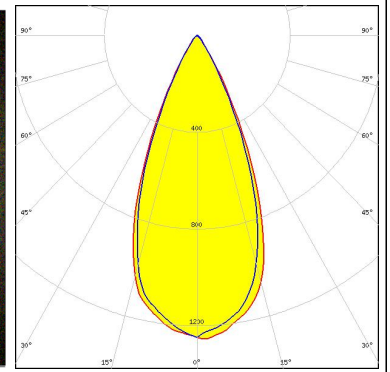

SAMSUNG

LED LC003D / LC006D / LC009D / LC013D
 FWHM / FWTM 44.0° / 66.0°
 Efficiency 69 %
 Peak intensity 1.3 cd/lm
 LEDs/each optic 1
 Light colour White
 Required components:
 F17435_HEKLA-G2-C

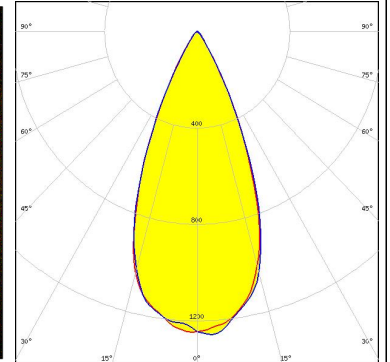
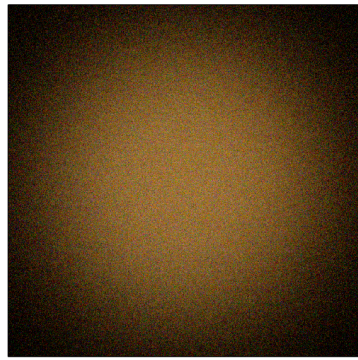

SAMSUNG

LED LC010C
 FWHM / FWTM 34.0° / 54.0°
 Efficiency 76 %
 Peak intensity 2.2 cd/lm
 LEDs/each optic 1
 Light colour White
 Required components:
 F17435_HEKLA-G2-C

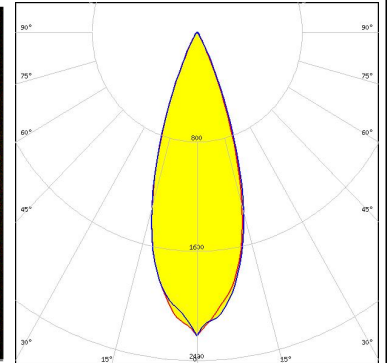

GENERAL INFORMATION:

NOTE: The typical beam angle will be changed by different color, chip size and chip position tolerance. The typical total beam angle is the full angle measured where the luminous intensity is half of the peak value.

Due to use of high power COB's with this product, special attention to proper thermal design is highly recommended. LEDiL has no liability for direct, indirect or consecutive damages arising from the LEDiL products being used outside of the recommended temperature range.

MATERIALS:

As part of our continuous research and improvement processes, and to ensure the best possible quality and availability of our products, LEDiL reserves the right to change material grades without notice.

PRODUCT DATA USER AGREEMENT AND DISCLAIMER:

The measured data in the provided downloadable LEDiL Product Datasheets and Mechanical 2D-Drawings is rounded and provided as reference for planning. LEDiL Oy's optical specifications have been verified by conducting performance testing of the products in accordance with the company's quality system. The reported data are averaged results of multiple measurements with typical variation. LEDiL Oy reserves the right to without prior notification make changes and improvements to its products.

LEDiL Oy assumes neither warranty, nor guarantee nor any other liability of any kind for the contents and correctness of the provided data. The provided data has been generated with highest diligence but the provided data may in reality not represent the complete possible variation range of all intrinsic parameters. Therefore, in certain cases a deviation from the provided data could occur.

LEDiL Oy reserves the right to undertake technical changes of its products without further notification which could lead to changes in the provided data. LEDiL Oy assumes no liability of any kind for the possible deviation from any provided data or any other damage resulting from the usage of the provided data.

The user agrees to this disclaimer and user agreement with the download or usage of the provided files.

LEDiL Oy

Joensuunkatu 13
FI-24240 SALO
Finland

LEDiL Inc.

228 West Page Street
Suite D
Sycamore IL 60178
USA

Ledil Optics Technology (Shenzhen) Co., Ltd.

405 , Block B
Casic Motor Building
Shenzhen 518057
P.R.CHINA

Local sales and technical support

[www.ledil.com/
where_to_buy](http://www.ledil.com/where_to_buy)

Shipping locations

Salo, Finland
Hong Kong, China

Distribution Partners

[www.ledil.com/
where_to_buy](http://www.ledil.com/where_to_buy)