

GABRIELLA-45-S

~9° spot beam with holder

SPECIFICATION:

Dimensions	Ø 45.0 mm
Height	28.9 mm
Fastening	pin, screw
ROHS compliant	yes ⓘ

MATERIALS:

Component	Type	Material	Colour	Finish
C15927_GABRIELLA-45-S	Single lens	PMMA	clear	
C15528_GABRIELLA-45-HLD	Holder	PC	black	

ORDERING INFORMATION:

Quantities for one set:

Single lens	1
Holder	1

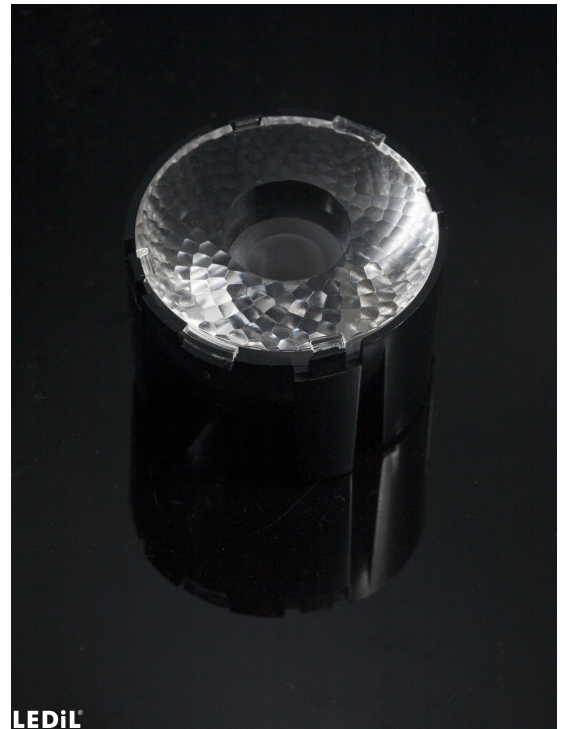

Component		Qty in box	MOQ	MPQ	Box weight (kg)
C15927_GABRIELLA-45-S	Single lens	405	90	45	11.5
» Box size: 476 x 273 x 292 mm					
C15528_GABRIELLA-45-HLD	Holder	405	90	45	5.1
» Box size: 476 x 273 x 292 mm					

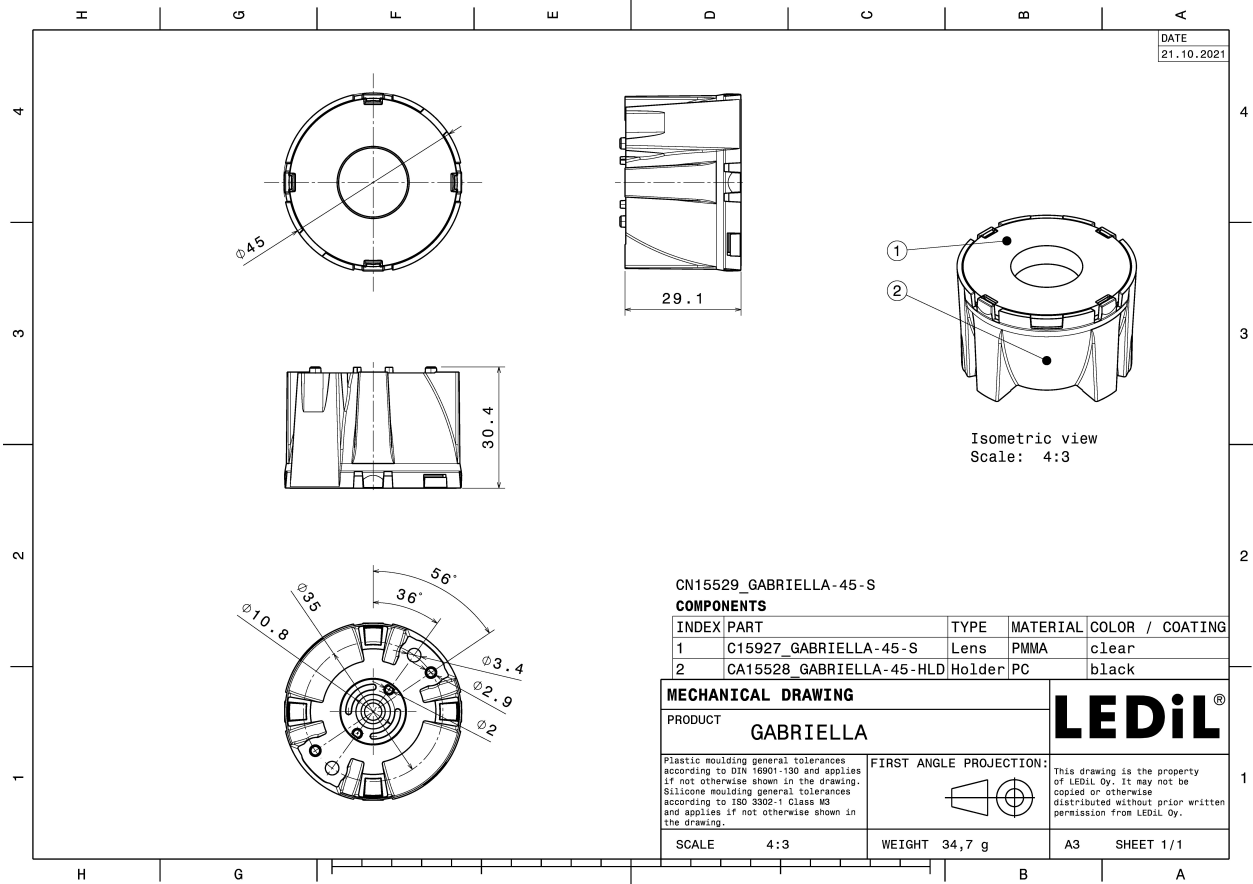

See also our general installation guide: www.ledil.com/installation_guide

OPTICAL RESULTS (MEASURED):



LED XM-L RGBW (XMLCTW)
 FWHM / FWTM 12.0° / 21.0°
 Efficiency 87 %
 Peak intensity 17 cd/lm
 LEDs/each optic 1
 Light colour White
 Required components:

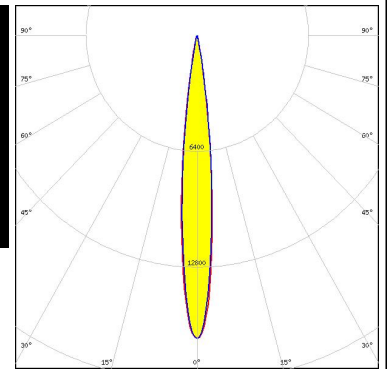

LED LUXEON 5052 RGBW
 FWHM / FWTM 12.0° / 23.0°
 Efficiency 91 %
 Peak intensity 14.8 cd/lm
 LEDs/each optic 1
 Light colour RGBW
 Required components:

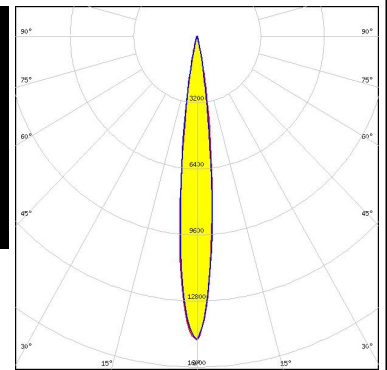
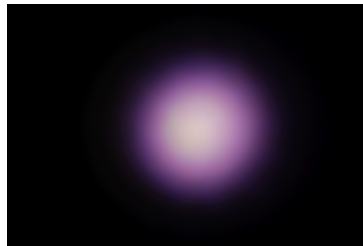



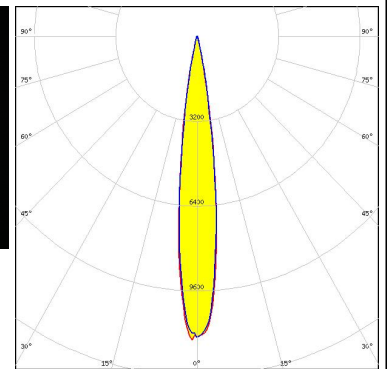

LED LUXEON CZ
 FWHM / FWTM 14.0° / 25.0°
 Efficiency 88 %
 Peak intensity 11.4 cd/lm
 LEDs/each optic 4
 Light colour RGBW
 Required components:

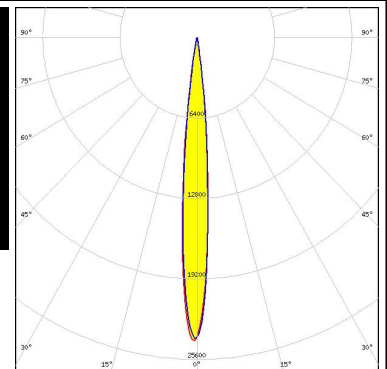



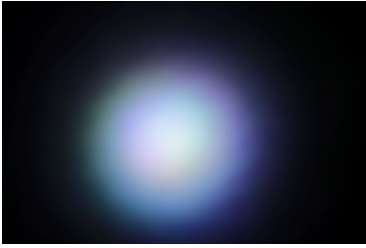
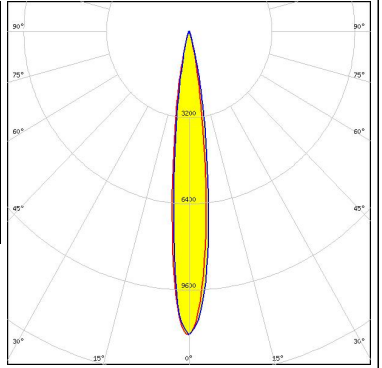
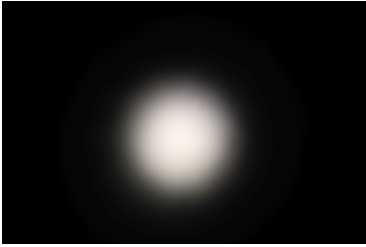
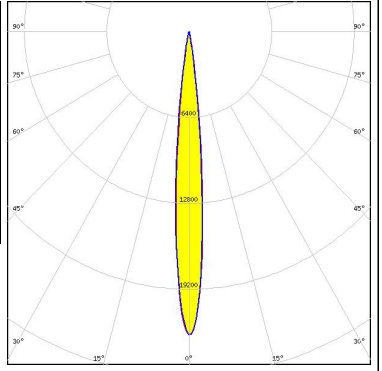

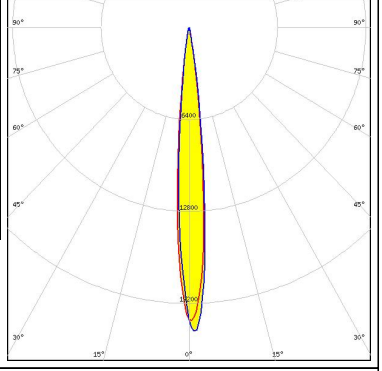

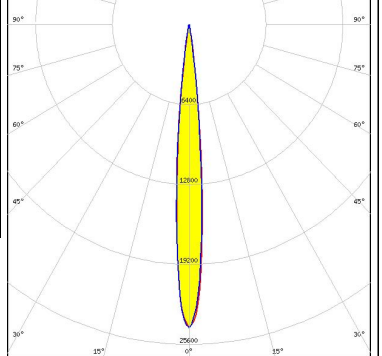
LED SBM-40-RGBW
 FWHM / FWTM 10.0° / 18.0°
 Efficiency 90 %
 Peak intensity 24 cd/lm
 LEDs/each optic 1
 Light colour White
 Required components:





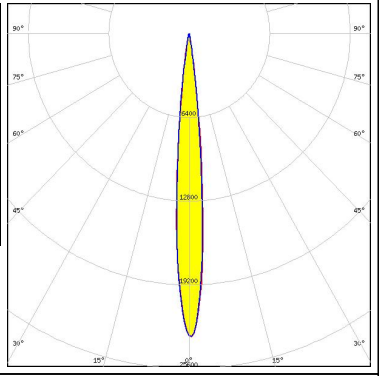

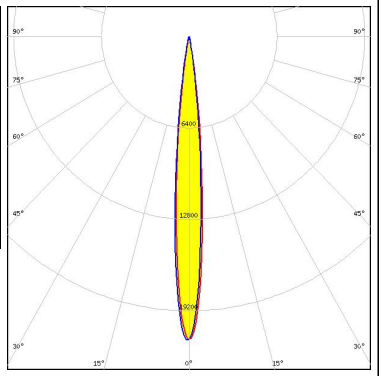

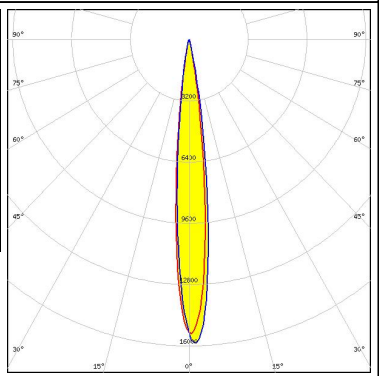
OPTICAL RESULTS (MEASURED):

<p>NICHIA</p> <p>LED NCSxE17A FWHM / FWTM 13.0° / 27.0° Efficiency 91 % Peak intensity 11 cd/lm LEDs/each optic 4 Light colour RGBW Required components:</p>		
<p>NICHIA</p> <p>LED NVSW219F FWHM / FWTM 10.0° / 18.0° Efficiency 91 % Peak intensity 22.7 cd/lm LEDs/each optic 1 Light colour White Required components:</p>		
<p>OSRAM <small>Opto Semiconductors</small></p> <p>LED OSLON Square EC FWHM / FWTM 10.0° / 19.0° Efficiency 88 % Peak intensity 21.3 cd/lm LEDs/each optic 1 Light colour White Required components:</p>		
<p>OSRAM <small>Opto Semiconductors</small></p> <p>LED OSTAR Stage (S2WN) FWHM / FWTM 10.0° / 17.0° Efficiency 87 % Peak intensity 24 cd/lm LEDs/each optic 1 Light colour White Required components:</p>		

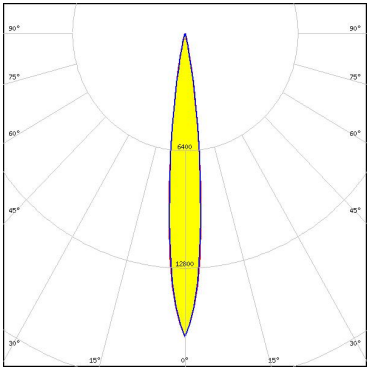
OPTICAL RESULTS (MEASURED):

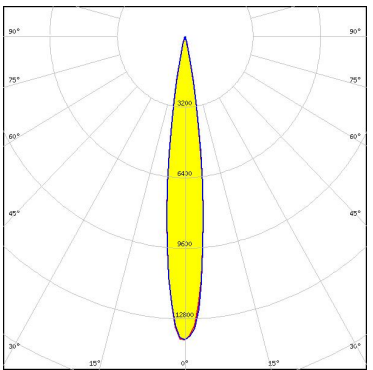
<p> SEUL SEMICONDUCTOR</p> <p>LED SPF05F0A</p> <p>FWHM / FWTM 10.0° / 18.0°</p> <p>Efficiency 89 %</p> <p>Peak intensity 23.4 cd/lm</p> <p>LEDs/each optic 1</p> <p>Light colour RGBW</p> <p>Required components:</p>		
<p> SEUL SEMICONDUCTOR</p> <p>LED SPF05F0B</p> <p>FWHM / FWTM 10.0° / 19.0°</p> <p>Efficiency 90 %</p> <p>Peak intensity 21.3 cd/lm</p> <p>LEDs/each optic 1</p> <p>Light colour RGBW</p> <p>Required components:</p>		
<p> SEUL SEMICONDUCTOR</p> <p>LED SPF05F0C</p> <p>FWHM / FWTM 12.0° / 22.0°</p> <p>Efficiency 89 %</p> <p>Peak intensity 15.9 cd/lm</p> <p>LEDs/each optic 1</p> <p>Light colour RGBW</p> <p>Required components:</p>		

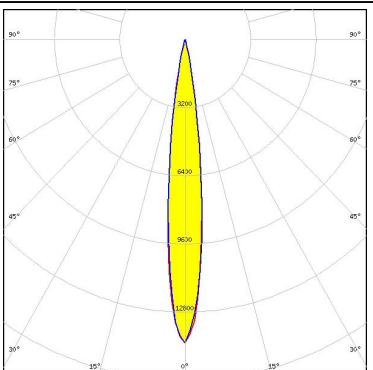
OPTICAL RESULTS (SIMULATED):

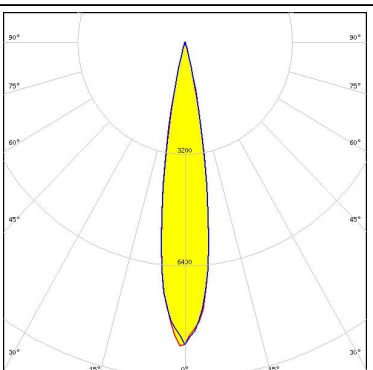
	<p>LED CLQ6A-TKW FWHM / FWTM 12.3° / 23.3° Efficiency 94 % Peak intensity 16.6 cd/lm LEDs/each optic 1 Light colour RGBW Required components:</p>	
	<p>LED XHP50 FWHM / FWTM 14.0° / 24.0° Efficiency 92 % Peak intensity 13.8 cd/lm LEDs/each optic 1 Light colour White Required components:</p>	
	<p>LED XHP50.2 FWHM / FWTM 13.0° / 25.0° Efficiency 91 % Peak intensity 14.3 cd/lm LEDs/each optic 1 Light colour White Required components:</p>	
	<p>LED XHP70 FWHM / FWTM 18.0° / 29.0° Efficiency 90 % Peak intensity 8.9 cd/lm LEDs/each optic 1 Light colour White Required components:</p>	

OPTICAL RESULTS (SIMULATED):



LED XHP70.2
 FWHM / FWTM 17.0° / 30.0°
 Efficiency 89 %
 Peak intensity 8.1 cd/lm
 LEDs/each optic 1
 Light colour White
 Required components:

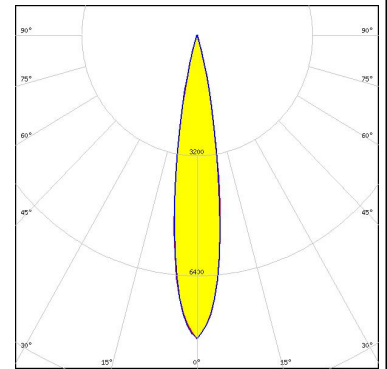

LED XM-L RGBW (XMLDCL HD)
 FWHM / FWTM 14.0° / 25.0°
 Efficiency 94 %
 Peak intensity 13.6 cd/lm
 LEDs/each optic 1
 Light colour RGBW
 Required components:

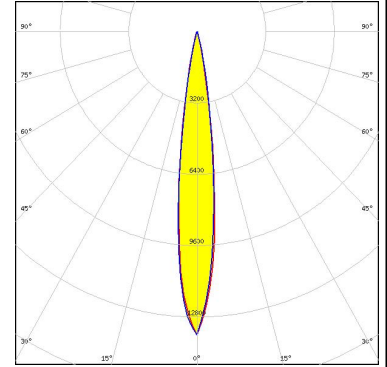

LED XM-L RGBW (XMLDCL HI)
 FWHM / FWTM 12.0° / 22.0°
 Efficiency 94 %
 Peak intensity 18.8 cd/lm
 LEDs/each optic 1
 Light colour RGBW
 Required components:

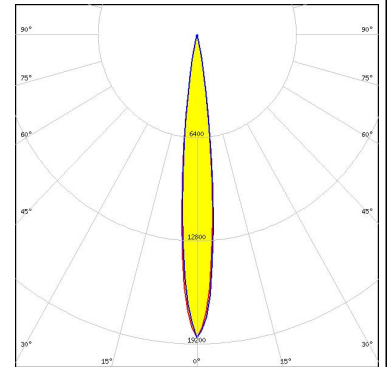

LED XP-E2
 FWHM / FWTM 10.0° / 18.0°
 Efficiency 93 %
 Peak intensity 26.7 cd/lm
 LEDs/each optic 1
 Light colour Amber
 Required components:

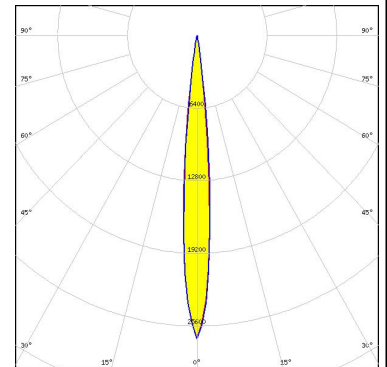

OPTICAL RESULTS (SIMULATED):

<p>LED ENGIN</p> <p>LED LZ4-04MDPB FWHM / FWTM 10.0° / 18.0° Efficiency 92 % Peak intensity 28.4 cd/lm LEDs/each optic 1 Light colour White Required components:</p>	
<p>LUMILEDS</p> <p>LED LUXEON 7070 FWHM / FWTM 16.0° / 30.0° Efficiency 92 % Peak intensity 9.4 cd/lm LEDs/each optic 1 Light colour White Required components:</p>	
<p>LUMILEDS</p> <p>LED LUXEON C FWHM / FWTM 14.0° / 24.0° Efficiency 85 % Peak intensity 11.5 cd/lm LEDs/each optic 4 Light colour RGBW Required components:</p>	
<p>LUMILEDS</p> <p>LED LUXEON Rubix FWHM / FWTM 12.0° / 22.0° Efficiency 94 % Peak intensity 18 cd/lm LEDs/each optic 4 Light colour RGBW Required components:</p>	

OPTICAL RESULTS (SIMULATED):

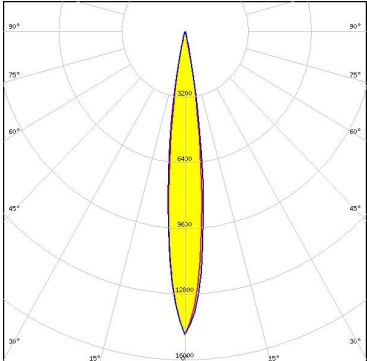
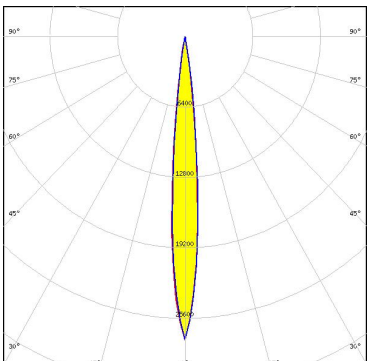
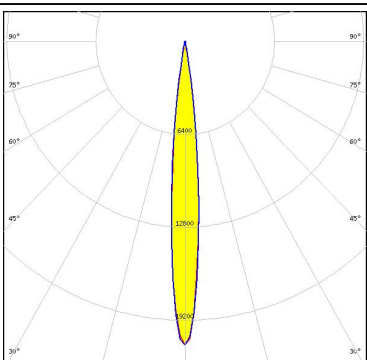
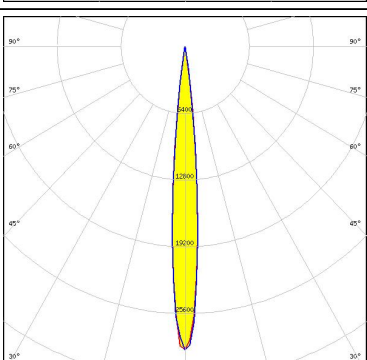
<p>OSRAM Opto Semiconductors</p> <p>LED DURIS E 5050 (GW J9LHS1.4M)</p> <p>FWHM / FWTM 13.0 + 14.0° / 24.0°</p> <p>Efficiency 93 %</p> <p>Peak intensity 14.8 cd/lm</p> <p>LEDs/each optic 1</p> <p>Light colour RGBW</p> <p>Required components:</p>	
<p>OSRAM Opto Semiconductors</p> <p>LED OSLOM Square CSSRM2/CSSRM3</p> <p>FWHM / FWTM 10.0° / 18.0°</p> <p>Efficiency 93 %</p> <p>Peak intensity 27.6 cd/lm</p> <p>LEDs/each optic 1</p> <p>Light colour White</p> <p>Required components:</p>	
<p>OSRAM Opto Semiconductors</p> <p>LED OSTAR Stage (S2WP)</p> <p>FWHM / FWTM 11.0° / 19.0°</p> <p>Efficiency 92 %</p> <p>Peak intensity 22.8 cd/lm</p> <p>LEDs/each optic 1</p> <p>Light colour White</p> <p>Required components:</p>	
<p>OSRAM Opto Semiconductors</p> <p>LED Ostar-SMT RGB</p> <p>FWHM / FWTM 10.0° / 17.0°</p> <p>Efficiency 92 %</p> <p>Peak intensity 31.6 cd/lm</p> <p>LEDs/each optic 1</p> <p>Light colour White</p> <p>Required components:</p>	

OPTICAL RESULTS (SIMULATED):

OSRAM
Opto Semiconductors

LED	SFH 4717AS
FWHM / FWTM	10.0° / 20.0°
Efficiency	93 %
LEDs/each optic	1
Light colour	IR
Required components:	

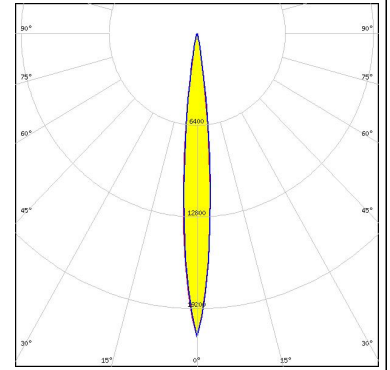
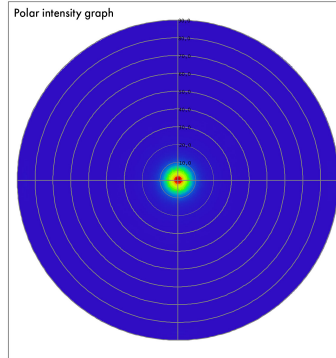

GENERAL INFORMATION:

NOTE: The typical beam angle will be changed by different color, chip size and chip position tolerance. The typical total beam angle is the full angle measured where the luminous intensity is half of the peak value.

MATERIALS:

As part of our continuous research and improvement processes, and to ensure the best possible quality and availability of our products, LEDiL reserves the right to change material grades without notice.

PRODUCT DATA USER AGREEMENT AND DISCLAIMER:

The measured data in the provided downloadable LEDiL Product Datasheets and Mechanical 2D-Drawings is rounded and provided as reference for planning. LEDiL Oy's optical specifications have been verified by conducting performance testing of the products in accordance with the company's quality system. The reported data are averaged results of multiple measurements with typical variation. LEDiL Oy reserves the right to without prior notification make changes and improvements to its products.

LEDiL Oy assumes neither warranty, nor guarantee nor any other liability of any kind for the contents and correctness of the provided data. The provided data has been generated with highest diligence but the provided data may in reality not represent the complete possible variation range of all intrinsic parameters. Therefore, in certain cases a deviation from the provided data could occur.

LEDiL Oy reserves the right to undertake technical changes of its products without further notification which could lead to changes in the provided data. LEDiL Oy assumes no liability of any kind for the possible deviation from any provided data or any other damage resulting from the usage of the provided data.

The user agrees to this disclaimer and user agreement with the download or usage of the provided files.

LEDiL Oy

Joensuunkatu 13
FI-24240 SALO
Finland

LEDiL Inc.

228 West Page Street
Suite D
Sycamore IL 60178
USA

Ledil Optics Technology (Shenzhen) Co., Ltd.

405 , Block B
Casic Motor Building
Shenzhen 518057
P.R.CHINA

Local sales and technical support

[www.ledil.com/
where_to_buy](http://www.ledil.com/where_to_buy)

Shipping locations

Salo, Finland
Hong Kong, China

Distribution Partners

[www.ledil.com/
where_to_buy](http://www.ledil.com/where_to_buy)