

TOP VIEW

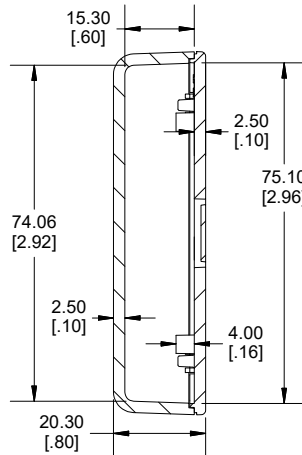

SECTION A-A
SIDE VIEW

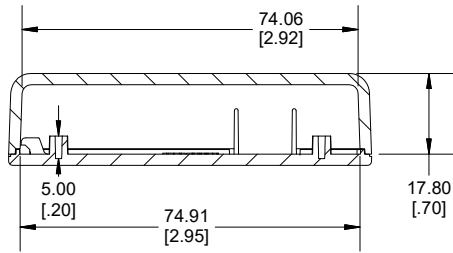
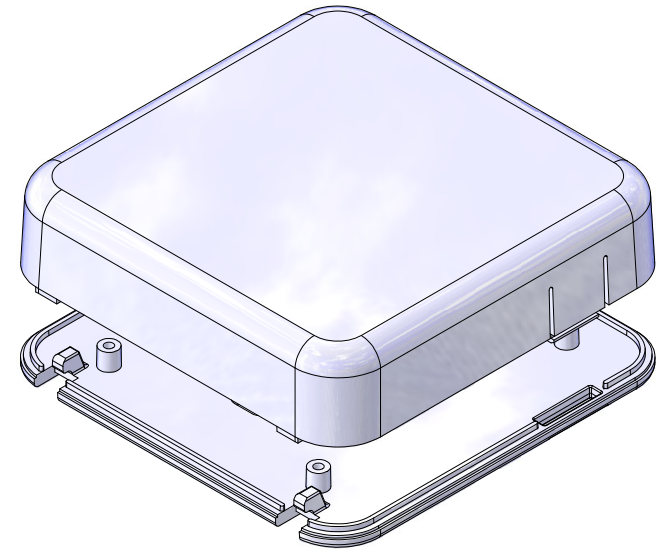

SECTION B-B
END VIEW

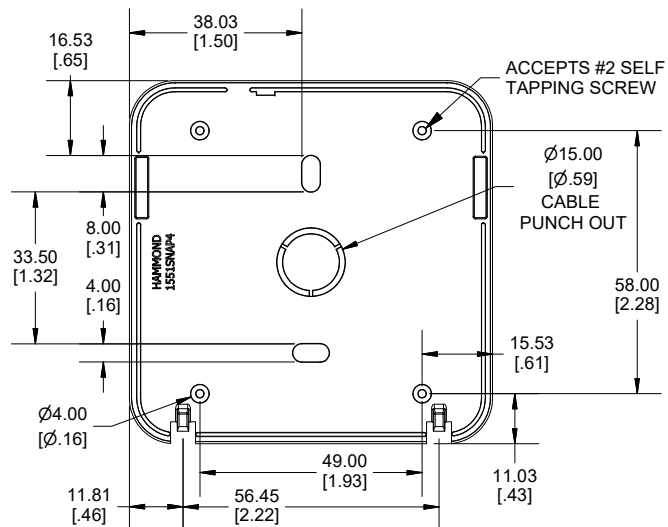

INSIDE BASE

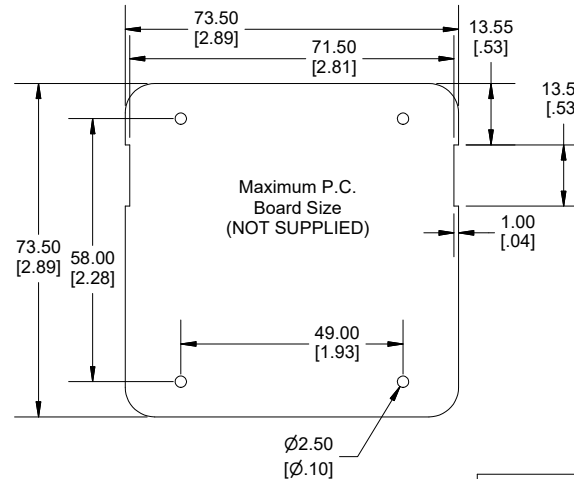

Dimensions:
mm
[inches]

Enclosures can be Factory Modified (Milling, Drilling, Printing etc.)
Contact Factory (modshop@hammfg.com) for quotes
Solid models of this enclosure available in .stp or .x_t
(Part number and text placement/orientation on our products are subject to change,
we do not recommend using them as a locating reference for modification purposes)

NOTE

Purchased assembly includes snap together base and cover. Enclosure molded from general purpose ABS Plastic.
Other materials / colours available consult factory.

Recommended Torque : (21-28) Ozf.in / (15-20) cN.m

PART NUMBERS

1551SNAP4 Enclosure

Black Enclosure - UL94 - HB	1551SNAP4BK
White Enclosure - UL94 - HB	1551SNAP4WH
Translucent Blue - UL94 - HB	1551SNAP4TBU

ACCESSORIES

P.C. Board Plastite Self Tapping Screw [#2 x 3/16" self-tapping (4.8mm)]	1553WTS100 (Pkg 100)
---	----------------------



1551SNAP4

www.hammondmfg.com