

RONDA-WWW

~90° very wide beam with holder A compatible with 3rd party connectors from TE, Bender+Wirth and IDEAL

SPECIFICATION:

Dimensions	Ø 69.9 mm
Height	14.6 mm
Fastening	socket
ROHS compliant	yes ⓘ



MATERIALS:

Component	Type	Material	Colour	Finish
F15157_RONDA-WWW	Single lens	PMMA	clear	
F15155_RONDA-HLD-A	Holder	PC	white	

ORDERING INFORMATION:

Quantities for one set:

Single lens	1
Holder	1



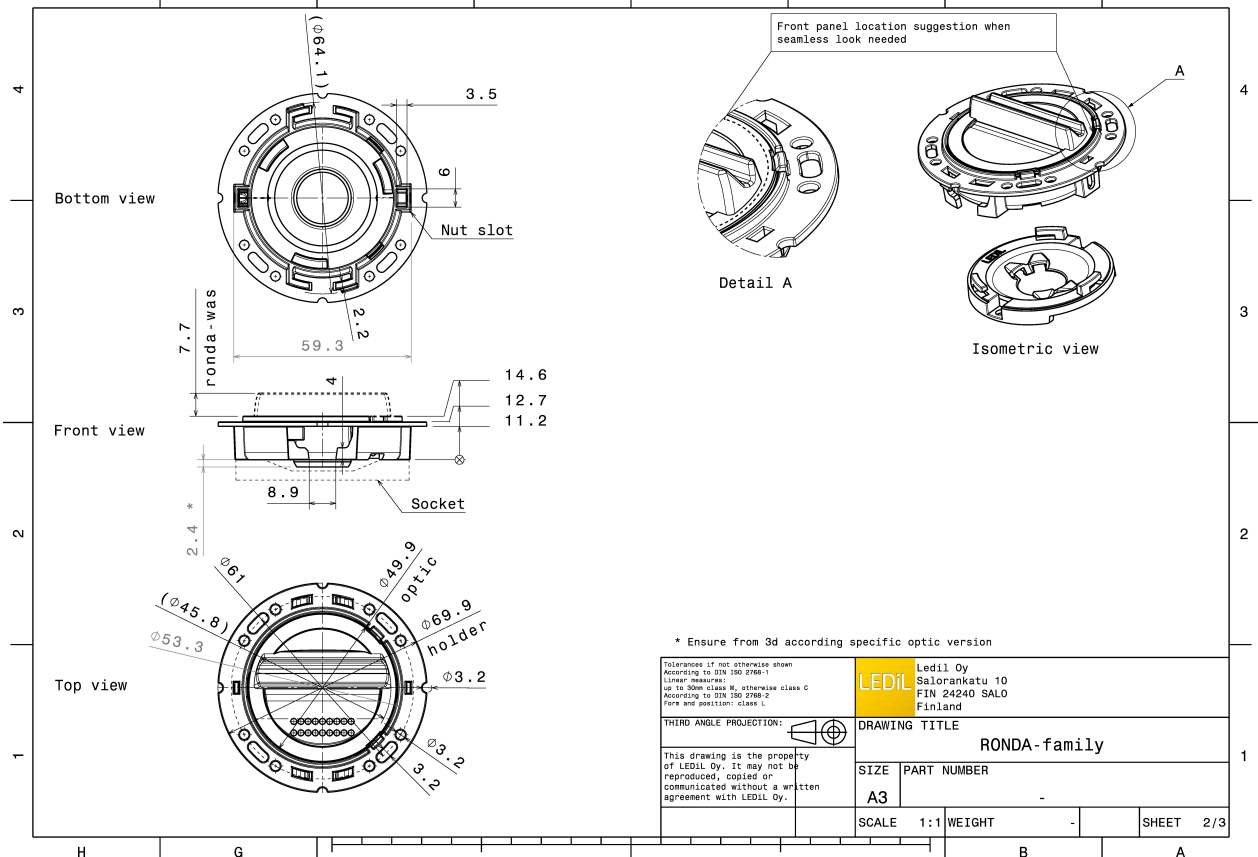
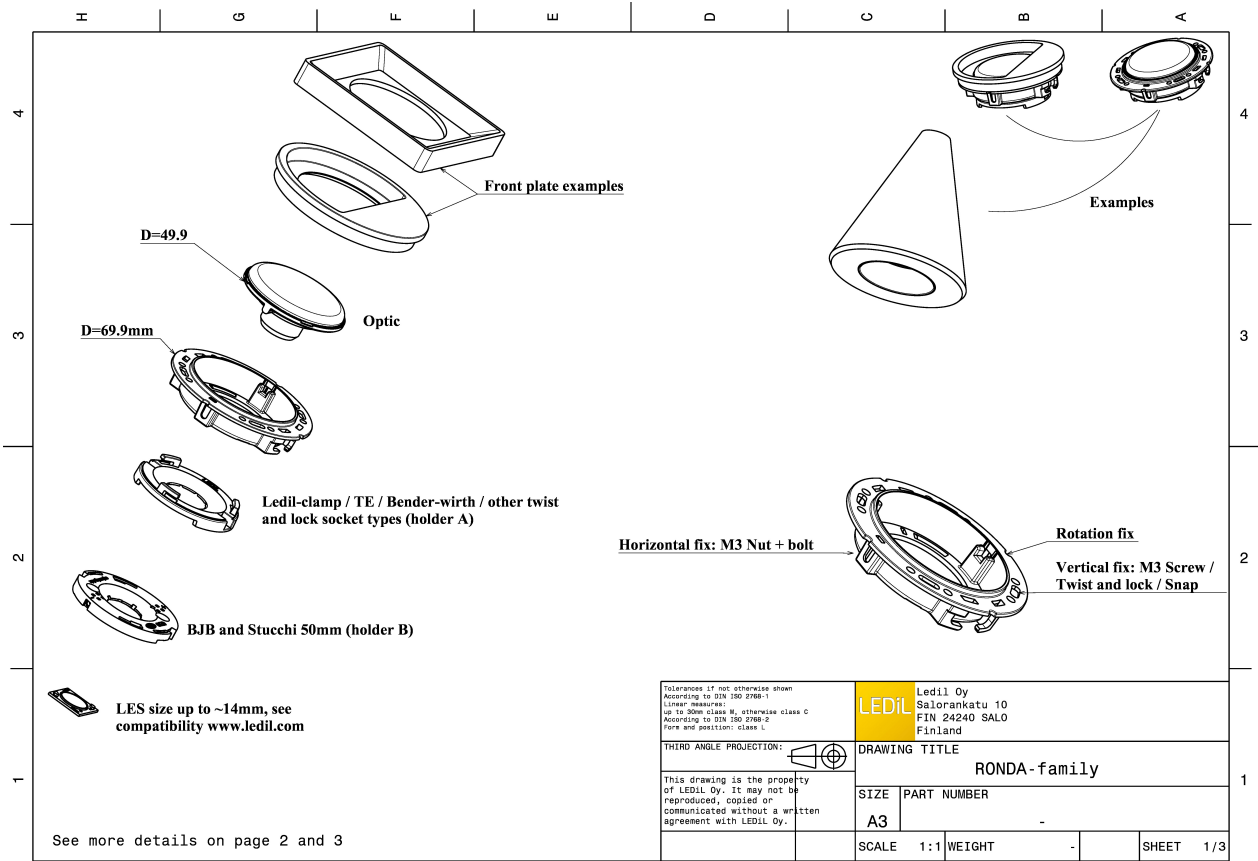

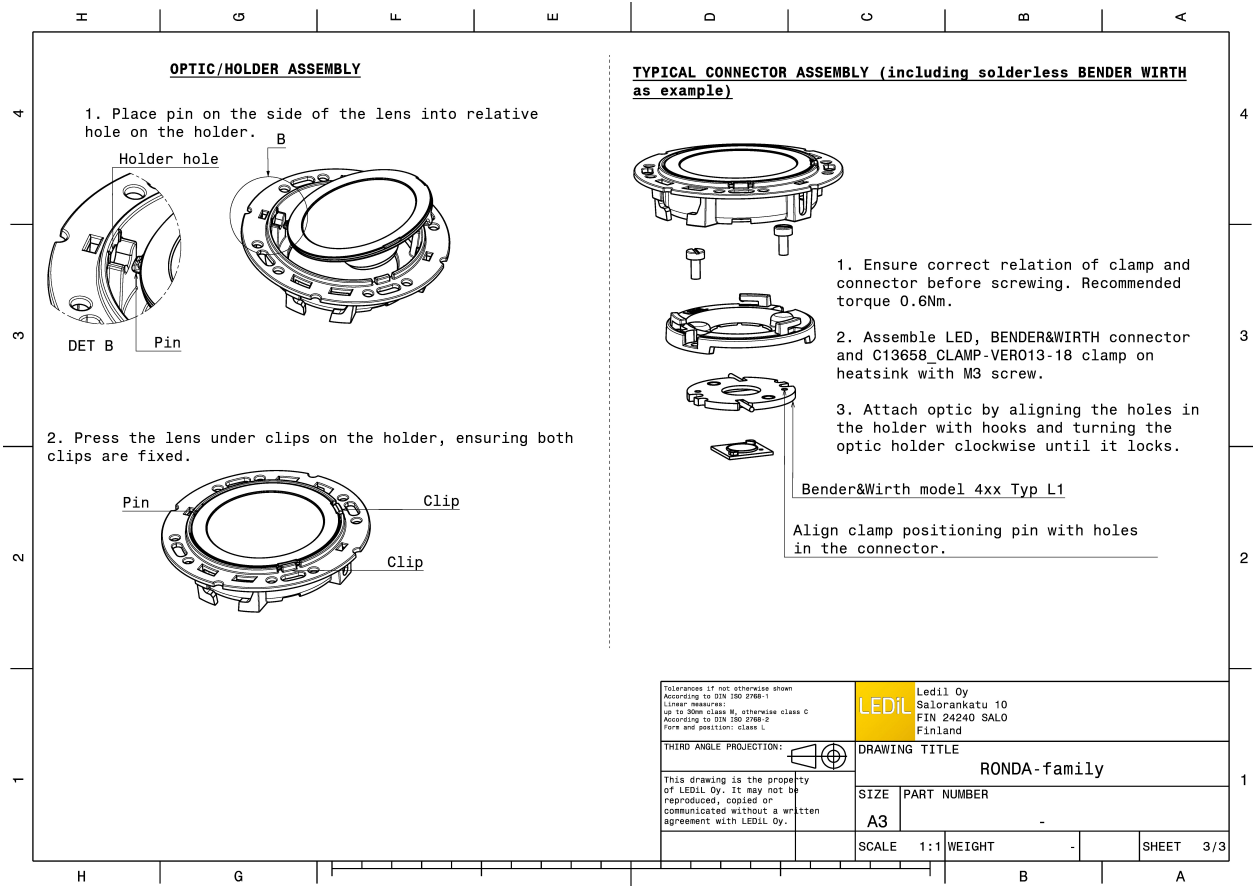

Component		Qty in box	MOQ	MPQ	Box weight (kg)
F15157_RONDA-WWW	Single lens	420	120	30	6.3
» Box size: 480 x 280 x 300 mm					
F15155_RONDA-HLD-A	Holder	420	120	30	4.4
» Box size: 480 x 280 x 300 mm					



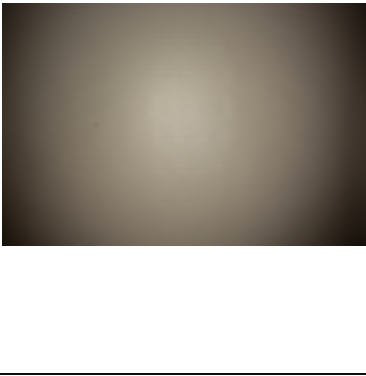
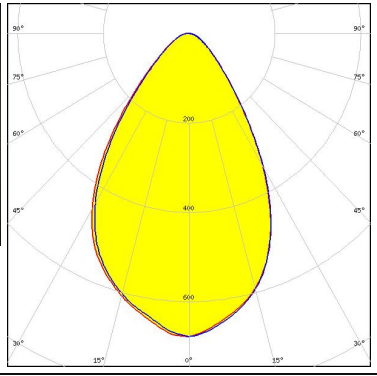

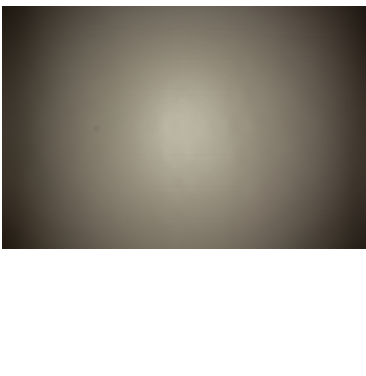
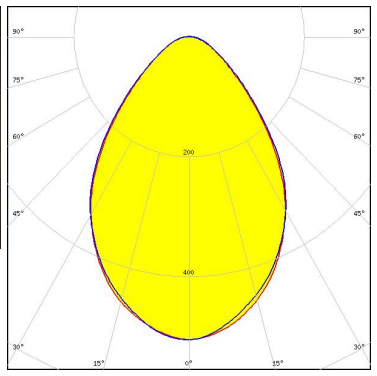
See also our general installation guide: www.ledil.com/installation_guide

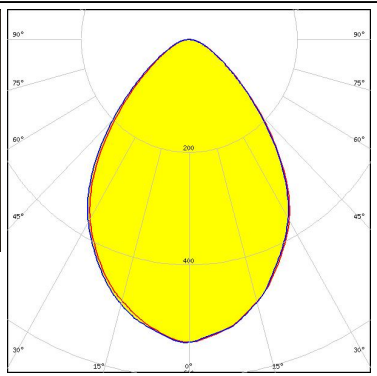
OPTICAL RESULTS (MEASURED):

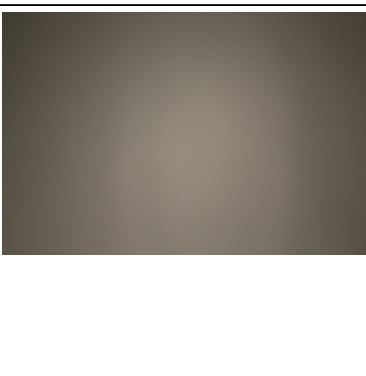
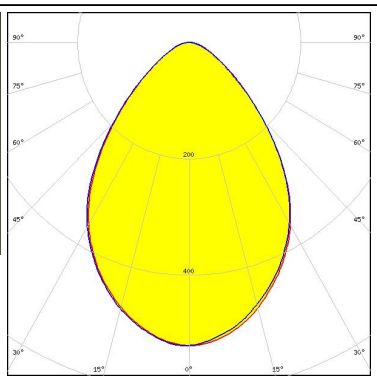
<p></p> <p>LED V10 Gen7 FWHM / FWTM 66.0° / 108.0° Efficiency 87 % Peak intensity 0.7 cd/lm LEDs/each optic 1 Light colour White</p> <p>Required components: C13658_CLAMP-VERO13-18 Bender Wirth: 486 Typ L1</p>		
<p></p> <p>LED V13 Gen7 FWHM / FWTM 76.0° / 126.0° Efficiency 82 % Peak intensity 0.5 cd/lm LEDs/each optic 1 Light colour White</p> <p>Required components: TE Connectivity: 2213254-2 + OPTIC CLIP Z50 TYPE1 2213194-1</p>		
<p></p> <p>LED Vero SE 13 FWHM / FWTM 78.0° / 124.0° Efficiency 88 % Peak intensity 0.5 cd/lm LEDs/each optic 1 Light colour White</p> <p>Required components: C16402_CLAMP-VEROSE-13-18</p>		
<p></p> <p>LED VERO13 FWHM / FWTM 78.0° / 125.0° Efficiency 87 % Peak intensity 0.5 cd/lm LEDs/each optic 1 Light colour White</p> <p>Required components: C13658_CLAMP-VERO13-18</p>		

OPTICAL RESULTS (MEASURED):

CITIZEN

LED CLL03x/CLU03x
 FWHM / FWTM 75.0° / 127.0°
 Efficiency 87 %
 Peak intensity 0.5 cd/lm
 LEDs/each optic 1
 Light colour White
 Required components:
 C16791_CLAMP-Z45-A
 TE Connectivity: 2325807-3

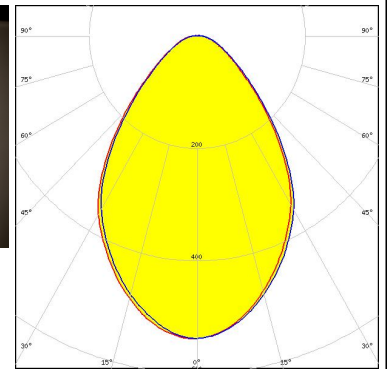

CITIZEN

LED CLL03x/CLU03x
 FWHM / FWTM 73.0° / 130.0°
 Efficiency 82 %
 Peak intensity 0.5 cd/lm
 LEDs/each optic 1
 Light colour White
 Required components:
 IDEAL: 50-2103CT + 50-2100AN

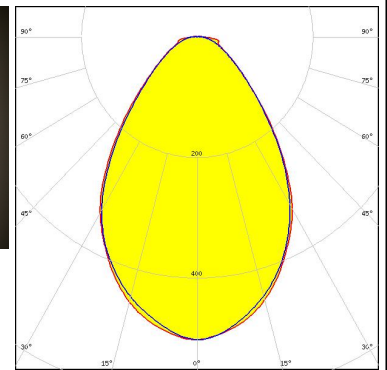
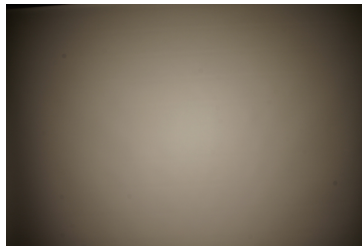

CITIZEN

LED CLL04x/CLU04x
 FWHM / FWTM 83.0° / 147.0°
 Efficiency 82 %
 Peak intensity 0.4 cd/lm
 LEDs/each optic 1
 Light colour White
 Required components:
 IDEAL: 50-2204-CT + 50-2100AN

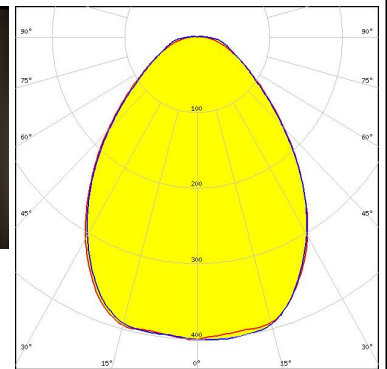
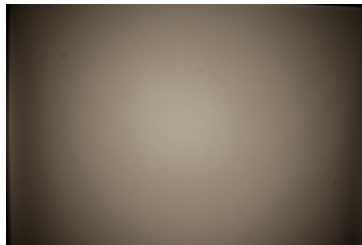



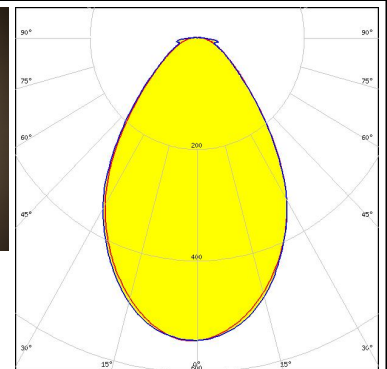
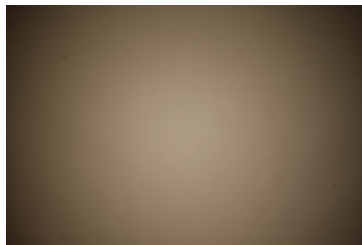

CITIZEN



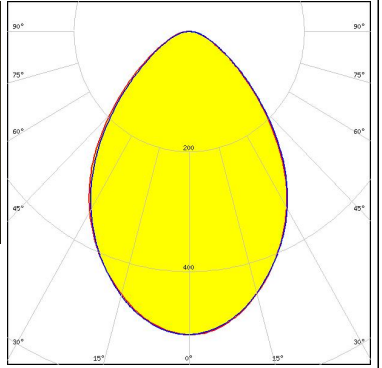

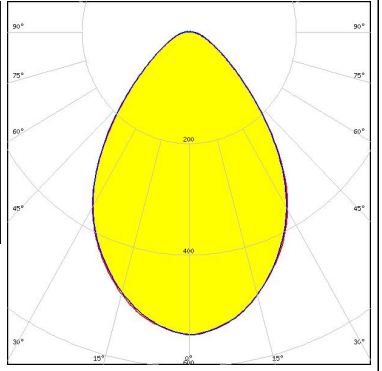
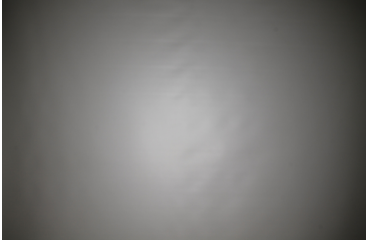
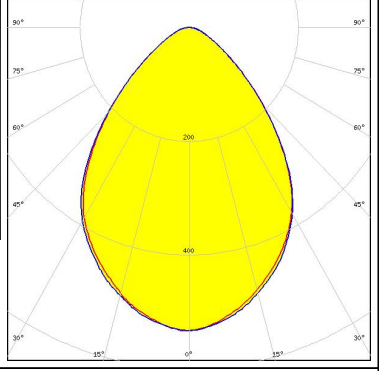

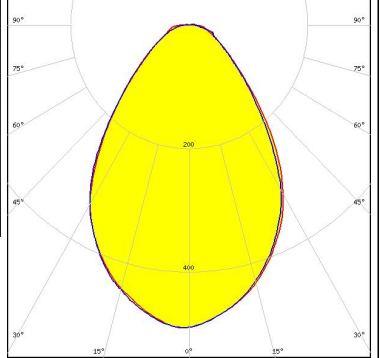
LED CLU730/731/733
 FWHM / FWTM 71.0° / 125.0°
 Efficiency 84 %
 Peak intensity 0.5 cd/lm
 LEDs/each optic 1
 Light colour White
 Required components:
 IDEAL: 50-2204-CT + 50-2100AN

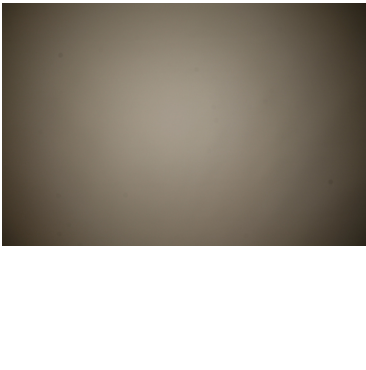
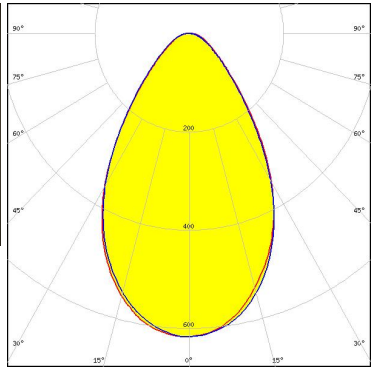

OPTICAL RESULTS (MEASURED):

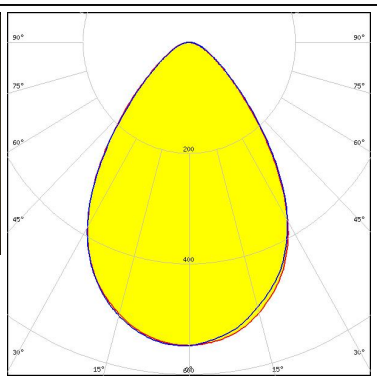
<p>CREE LEDs</p> <p>LED CMA1840 FWHM / FWTM 78.0° / 129.0° Efficiency 86 % Peak intensity 0.5 cd/lm LEDs/each optic 1 Light colour White Required components: C14123_CLAMP-CXA15-18</p>		
<p>CREE LEDs</p> <p>LED CXA/B 1816 & CXA/B 1820 & CXA 1850 FWHM / FWTM 75.0° / 122.0° Efficiency 85 % Peak intensity 0.5 cd/lm LEDs/each optic 1 Light colour White Required components: TE Connectivity: 2213401-2 + OPTIC CLIP Z50 TYPE1 2213194-1</p>		
<p>CREE LEDs</p> <p>LED CXA/B 1816 & CXA/B 1820 & CXA 1850 FWHM / FWTM 80.0° / 124.0° Efficiency 90 % Peak intensity 0.5 cd/lm LEDs/each optic 1 Light colour White Required components: C14123_CLAMP-CXA15-18</p>		
<p>NICHIA</p> <p>LED COB J-Type FWHM / FWTM 74.0° / 132.0° Efficiency 82 % Peak intensity 0.5 cd/lm LEDs/each optic 1 Light colour White Required components: IDEAL: 50-2103NC + 50-2100AN</p>		

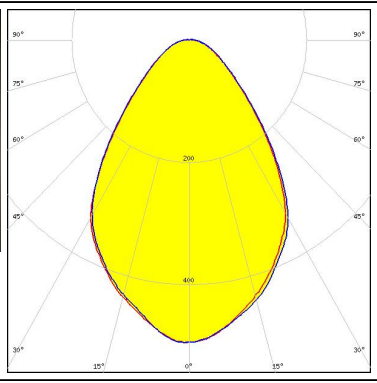
OPTICAL RESULTS (MEASURED):

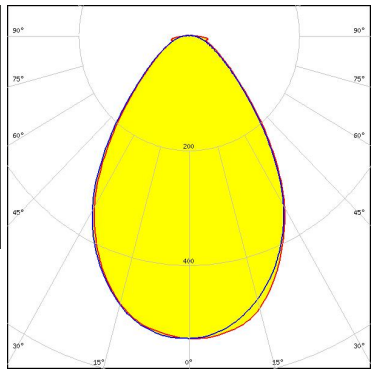
<p>NICHIA</p> <p>LED COB L-Type (LES 11)</p> <p>FWHM / FWTM 65.0° / 114.0°</p> <p>Efficiency 83 %</p> <p>Peak intensity 0.6 cd/lm</p> <p>LEDs/each optic 1</p> <p>Light colour White</p> <p>Required components: IDEAL: 50-2100NC + 50-2100AN</p>		
<p>NICHIA</p> <p>LED COB L-Type (LES 11)</p> <p>FWHM / FWTM 74.0° / 119.0°</p> <p>Efficiency 85 %</p> <p>Peak intensity 0.6 cd/lm</p> <p>LEDs/each optic 1</p> <p>Light colour White</p> <p>Required components: TE Connectivity: 2213382-2 + OPTIC CLIP Z50 TYPE1 2213194-1</p>		
<p>OSRAM</p> <p>LED PrevaLED Core G7 L15 H1</p> <p>FWHM / FWTM 73.0° / 128.0°</p> <p>Efficiency 79 %</p> <p>Peak intensity 0.5 cd/lm</p> <p>LEDs/each optic 1</p> <p>Light colour White</p> <p>Required components: C16685_CLAMP-PRV-A</p>		
<p>OSRAM Opto Semiconductors</p> <p>LED Soleriq S13 19x19</p> <p>FWHM / FWTM 72.0° / 125.0°</p> <p>Efficiency 83 %</p> <p>Peak intensity 0.5 cd/lm</p> <p>LEDs/each optic 1</p> <p>Light colour White</p> <p>Required components: IDEAL: 50-2103CT + 50-2100AN</p>		

OPTICAL RESULTS (MEASURED):

OSRAM

Opto Semiconductors

LED Soleriq S13 19x19
 FWHM / FWTM 75.0° / 123.0°
 Efficiency 84 %
 Peak intensity 0.5 cd/lm
 LEDs/each optic 1
 Light colour White

Required components:

TE Connectivity: 2213254-2 + OPTIC CLIP Z50 TYPE1 2213194-1

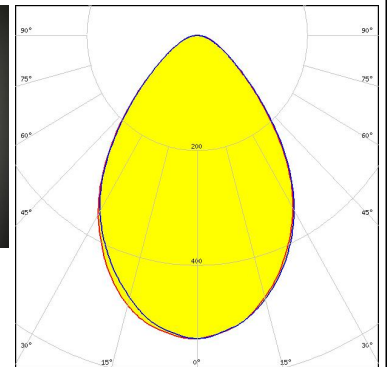
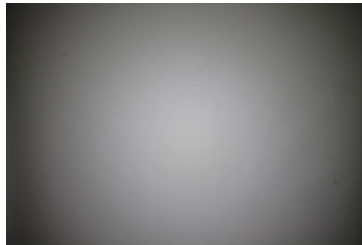

PHILIPS

LED Fortimo SLM L13 + SLM holder
 FWHM / FWTM 73.0° / 124.0°
 Efficiency 82 %
 Peak intensity 0.5 cd/lm
 LEDs/each optic 1
 Light colour White

Required components:

TE Connectivity: OPTIC CLIP Z50 TYPE1 2213194-1

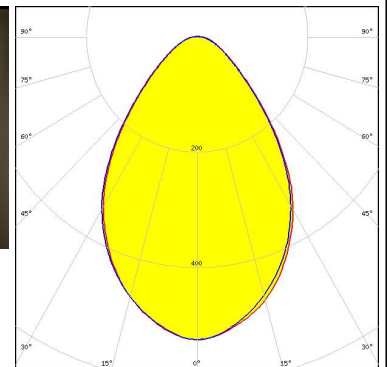
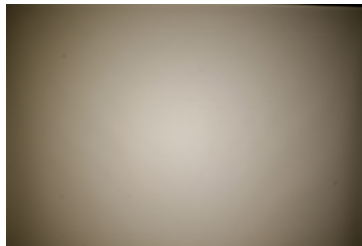

PHILIPS

LED Fortimo SLM L13 CoB
 FWHM / FWTM 78.0° / 125.0°
 Efficiency 82 %
 Peak intensity 0.5 cd/lm
 LEDs/each optic 1
 Light colour White

Required components:

TE Connectivity: 2213130-2 + OPTIC CLIP Z50 TYPE1 2213194-1

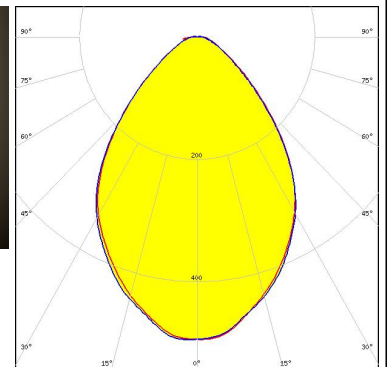
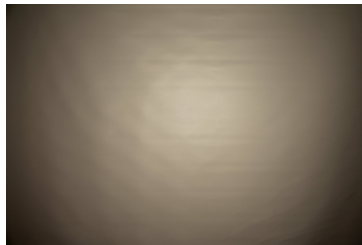

PHILIPS

LED Fortimo SLM L15 + SLM holder
 FWHM / FWTM 78.0° / 133.0°
 Efficiency 80 %
 Peak intensity 0.5 cd/lm
 LEDs/each optic 1
 Light colour White

Required components:

TE Connectivity: OPTIC CLIP Z50 TYPE1 2213194-1

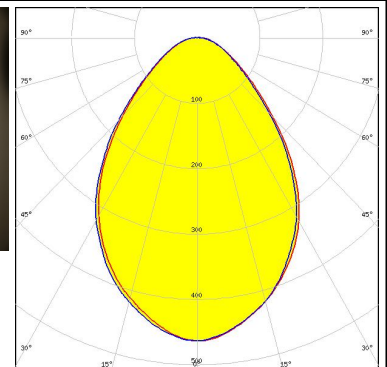
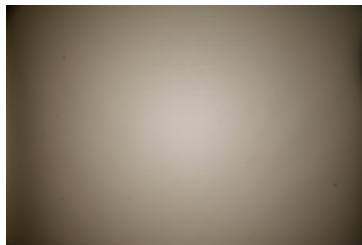

OPTICAL RESULTS (MEASURED):

SAMSUNG

LED LC040C
FWHM / FWTM 74.0° / 120.0°
Efficiency 85 %
Peak intensity 0.6 cd/lm
LEDs/each optic 1
Light colour White

Required components:

TE Connectivity: 2213382-2 + OPTIC CLIP Z50 TYPE1 2213194-1

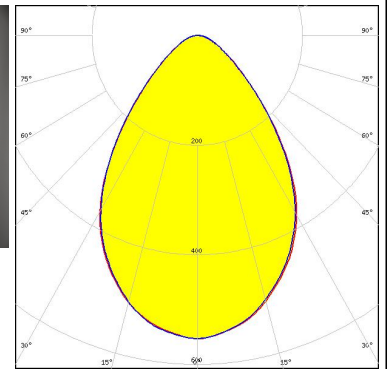

SEOUL SEMICONDUCTOR

LED AC Zhaga COB
FWHM / FWTM 78.0° / 130.0°
Efficiency 83 %
Peak intensity 0.5 cd/lm
LEDs/each optic 1
Light colour White

Required components:

Optosource: SEHSMJD-A

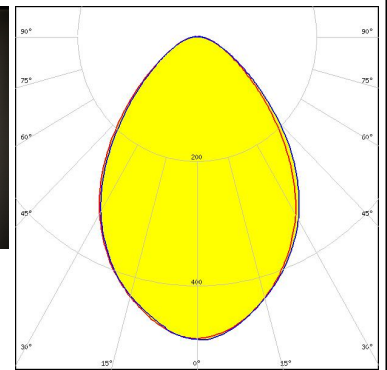

SEOUL SEMICONDUCTOR

LED MJT COB LES 14.5
FWHM / FWTM 79.0° / 130.0°
Efficiency 80 %
Peak intensity 0.5 cd/lm
LEDs/each optic 1
Light colour White

Required components:

TE Connectivity: 2213254-2 + OPTIC CLIP Z50 TYPE1 2213194-1

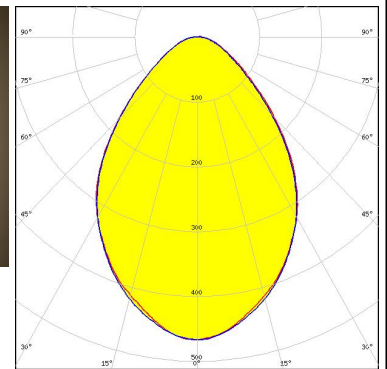
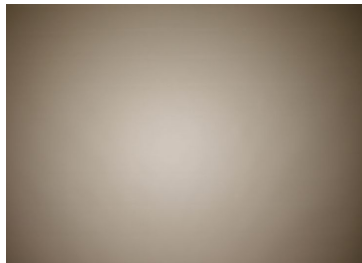

LED WU-M-484
FWHM / FWTM 79.0° / 130.0°
Efficiency 82 %
Peak intensity 0.5 cd/lm
LEDs/each optic 1
Light colour White

Required components:

TE Connectivity: OPTIC CLIP Z50 TYPE1 2213194-1

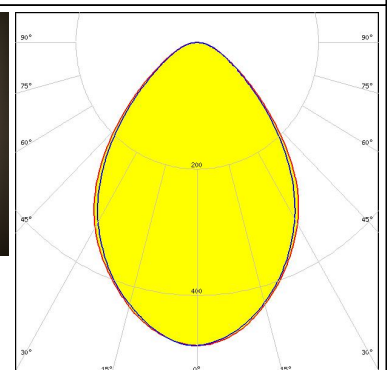
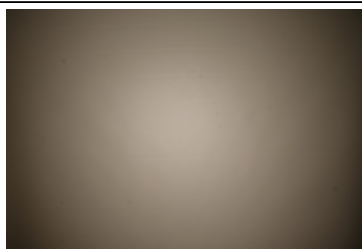

OPTICAL RESULTS (SIMULATED):

bridgelux.

LED V10 Gen6
 FWHM / FWTM 89.0° / 120.0 + 119.0°
 Efficiency 86 %
 Peak intensity 0.5 cd/lm
 LEDs/each optic 1
 Light colour White
 Required components:
 C14123_CLAMP-CXA15-18

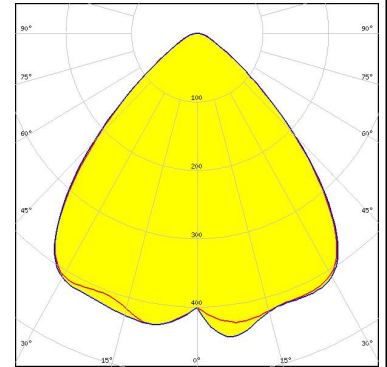

bridgelux.

LED V13 Gen7
 FWHM / FWTM 72.0° / 120.0°
 Efficiency 86 %
 Peak intensity 0.6 cd/lm
 LEDs/each optic 1
 Light colour White
 Required components:
 IDEAL: 50-2103CT + 50-2100AN

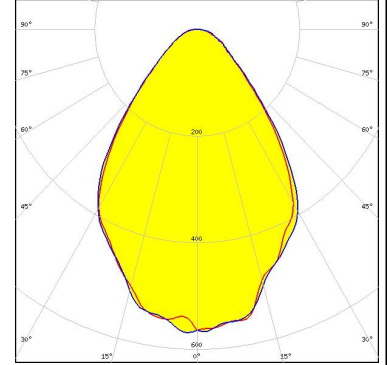

bridgelux.

LED V13 Gen7
 FWHM / FWTM 80.0° / 121.0°
 Efficiency 82 %
 Peak intensity 0.5 cd/lm
 LEDs/each optic 1
 Light colour White
 Required components:
 C13658_CLAMP-VERO13-18
 Bender Wirth: 477 Typ L1

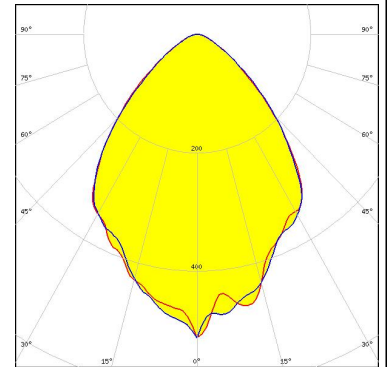

CITIZEN

LED CLL02x/CLU02x (LES10)
 FWHM / FWTM 90.0° / 120.0 + 121.0°
 Efficiency 86 %
 Peak intensity 0.4 cd/lm
 LEDs/each optic 1
 Light colour White
 Required components:
 C13658_CLAMP-VERO13-18
 Bender Wirth: 434 Typ L1

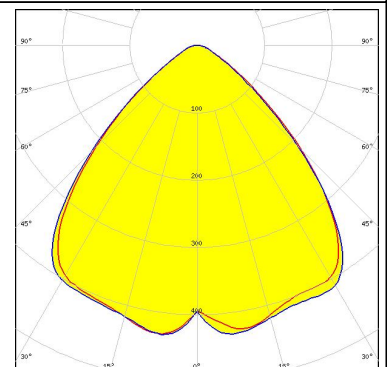

OPTICAL RESULTS (SIMULATED):

CITIZEN

LED CLU700/701/702/703
 FWHM / FWTM 90.0° / 97.0 + 113.0°
 Efficiency 87 %
 Peak intensity 0.5 cd/lm
 LEDs/each optic 1
 Light colour White
 Required components:
 C13658_CLAMP-VERO13-18
 Bender Wirth: 434 Typ L1

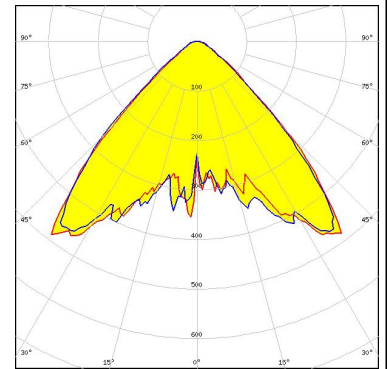

CITIZEN

LED CLU710/711
 FWHM / FWTM 88.0° / 118.0°
 Efficiency 87 %
 Peak intensity 0.5 cd/lm
 LEDs/each optic 1
 Light colour White
 Required components:
 C13658_CLAMP-VERO13-18
 Bender Wirth: 470 Typ L1

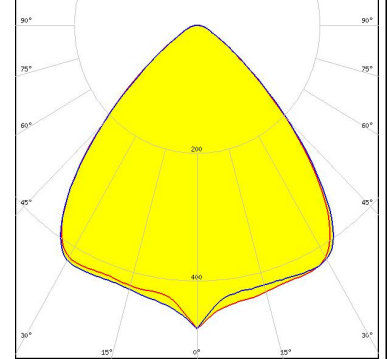

LED CXA/B 13xx
 FWHM / FWTM 90.0° / 103.0 + 118.0°
 Efficiency 87 %
 Peak intensity 0.5 cd/lm
 LEDs/each optic 1
 Light colour White
 Required components:
 C13658_CLAMP-VERO13-18
 Bender Wirth: 448 Typ L1

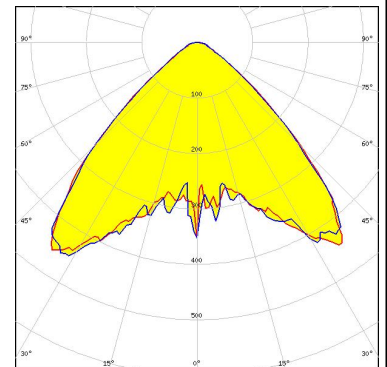

LED CXA/B 15xx
 FWHM / FWTM 90.0° / 116.0 + 124.0°
 Efficiency 87 %
 Peak intensity 0.4 cd/lm
 LEDs/each optic 1
 Light colour White
 Required components:
 C14123_CLAMP-CXA15-18

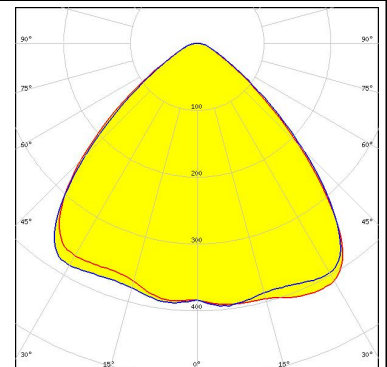

OPTICAL RESULTS (SIMULATED):



LED CXA/B 15xx
FWHM / FWTM 90.0° / 116.0 + 124.0°
Efficiency 87 %
Peak intensity 0.4 cd/lm
LEDs/each optic 1
Light colour White
Required components:
 C13658_CLAMP-VERO13-18
 Bender Wirth: 441 Typ L1

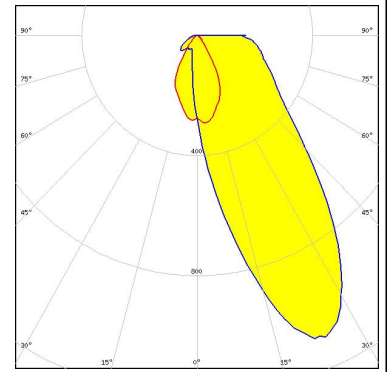

LED CXA/B 1816 & CXA/B 1820 & CXA 1850
FWHM / FWTM 90.0° / 124.0°
Efficiency 87 %
Peak intensity 0.4 cd/lm
LEDs/each optic 1
Light colour White
Required components:
 C13658_CLAMP-VERO13-18
 Bender Wirth: 437 Typ L1

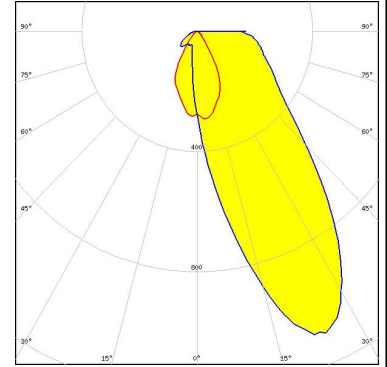

LED CXA/B 1830
FWHM / FWTM 84.0°
Efficiency 85 %
LEDs/each optic 1
Light colour White
Required components:
 C14123_CLAMP-CXA15-18



LED LUXEON CoB 1202/1203
FWHM / FWTM 82.0° / 112.0°
Efficiency 86 %
Peak intensity 0.5 cd/lm
LEDs/each optic 1
Light colour White
Required components:
 TE Connectivity: 2213382-2 + OPTIC CLIP Z50 TYPE1 2213194-1

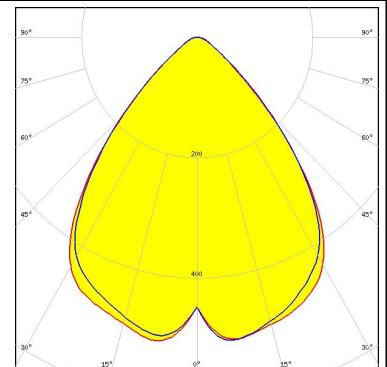

OPTICAL RESULTS (SIMULATED):

LUMILEDS

LED LUXEON CoB 1202s
 FWHM / FWTM 90.0° / 110.0 + 118.0°
 Efficiency 87 %
 Peak intensity 0.4 cd/lm
 LEDs/each optic 1
 Light colour White
 Required components:
 C13658_CLAMP-VERO13-18
 Bender Wirth: 452 Typ L1

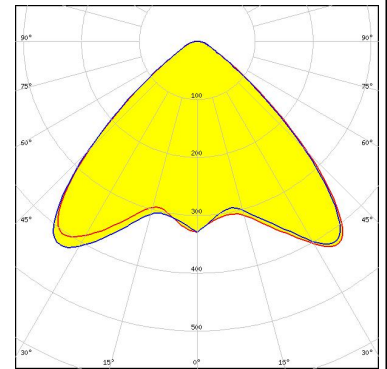

NICHIA

LED COB L-Type (LES 9)
 FWHM / FWTM 83.0° / 112.0°
 Efficiency 86 %
 Peak intensity 0.5 cd/lm
 LEDs/each optic 1
 Light colour White
 Required components:
 TE Connectivity: 2213382-2 + OPTIC CLIP Z50 TYPE1 2213194-1

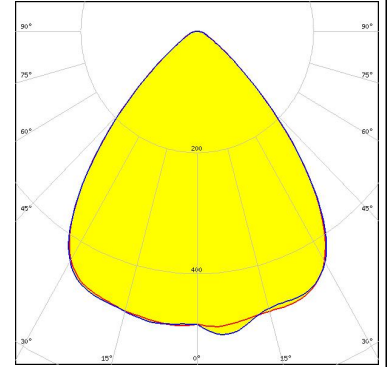

NICHIA

LED NSCxL036A
 FWHM / FWTM 85.0° / 109.0 + 100.0°
 Efficiency 87 %
 Peak intensity 0.5 cd/lm
 LEDs/each optic 1
 Light colour White
 Required components:
 TE Connectivity: 2213382-2 + OPTIC CLIP Z50 TYPE1 2213194-1

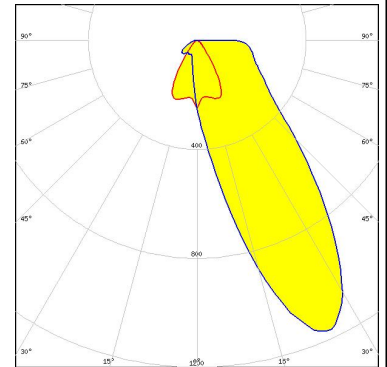

OSRAM

Opto Semiconductors
 LED Duris S10
 FWHM / FWTM 99.0° / 128.0 + 118.0°
 Efficiency 86 %
 Peak intensity 0.4 cd/lm
 LEDs/each optic 1
 Light colour White
 Required components:
 C13658_CLAMP-VERO13-18

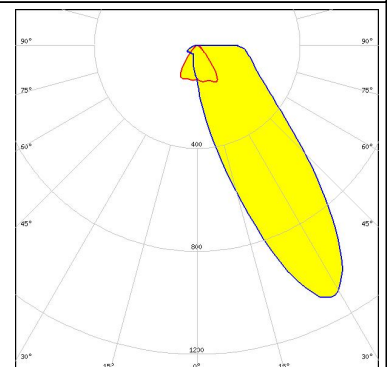

OPTICAL RESULTS (SIMULATED):

SHARP

LED Mini Zenigata (GW6BM)
FWHM / FWTM 88.0° / 116.0 + 114.0°
Efficiency 86 %
Peak intensity 0.5 cd/lm
LEDs/each optic 1
Light colour White
Required components:
C13658_CLAMP-VERO13-18
Bender Wirth: 452 Typ L1

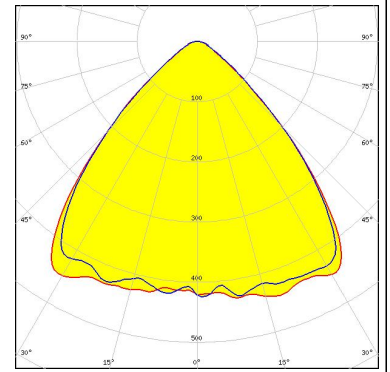

GENERAL INFORMATION:

NOTE: The typical beam angle will be changed by different color, chip size and chip position tolerance. The typical total beam angle is the full angle measured where the luminous intensity is half of the peak value.

Due to use of high power COB's with this product, special attention to proper thermal design is highly recommended. LEDiL has no liability for direct, indirect or consecutive damages arising from the LEDiL products being used outside of the recommended temperature range.

MATERIALS:

As part of our continuous research and improvement processes, and to ensure the best possible quality and availability of our products, LEDiL reserves the right to change material grades without notice.

PRODUCT DATA USER AGREEMENT AND DISCLAIMER:

The measured data in the provided downloadable LEDiL Product Datasheets and Mechanical 2D-Drawings is rounded and provided as reference for planning. LEDiL Oy's optical specifications have been verified by conducting performance testing of the products in accordance with the company's quality system. The reported data are averaged results of multiple measurements with typical variation. LEDiL Oy reserves the right to without prior notification make changes and improvements to its products.

LEDiL Oy assumes neither warranty, nor guarantee nor any other liability of any kind for the contents and correctness of the provided data. The provided data has been generated with highest diligence but the provided data may in reality not represent the complete possible variation range of all intrinsic parameters. Therefore, in certain cases a deviation from the provided data could occur.

LEDiL Oy reserves the right to undertake technical changes of its products without further notification which could lead to changes in the provided data. LEDiL Oy assumes no liability of any kind for the possible deviation from any provided data or any other damage resulting from the usage of the provided data.

The user agrees to this disclaimer and user agreement with the download or usage of the provided files.

LEDiL Oy

Joensuunkatu 13
FI-24240 SALO
Finland

LEDiL Inc.

228 West Page Street
Suite D
Sycamore IL 60178
USA

Ledil Optics Technology (Shenzhen) Co., Ltd.

405 , Block B
Casic Motor Building
Shenzhen 518057
P.R.CHINA

Local sales and technical support

[www.ledil.com/
where_to_buy](http://www.ledil.com/where_to_buy)

Shipping locations

Salo, Finland
Hong Kong, China

Distribution Partners

[www.ledil.com/
where_to_buy](http://www.ledil.com/where_to_buy)