

VERONICA-SQ-MINI-M

~35° medium beam

SPECIFICATION:

Dimensions	13.9 x 13.9 mm
Height	8.9 mm
Fastening	tape, pin
ROHS compliant	yes ⓘ

MATERIALS:

Component	Type	Material	Colour	Finish
VERONICA-SQ-MINI-M	Single lens	PMMA	clear	
VERONICA-SQ-MINI-TAPE	Tape	Acrylic foam	clear	

ORDERING INFORMATION:

Component		Qty in box	MOQ	MPQ	Box weight (kg)
CA15230_VERONICA-SQ-MINI-M	Single lens	5544	252	252	8.5
» Box size: 480 x 280 x 300 mm					



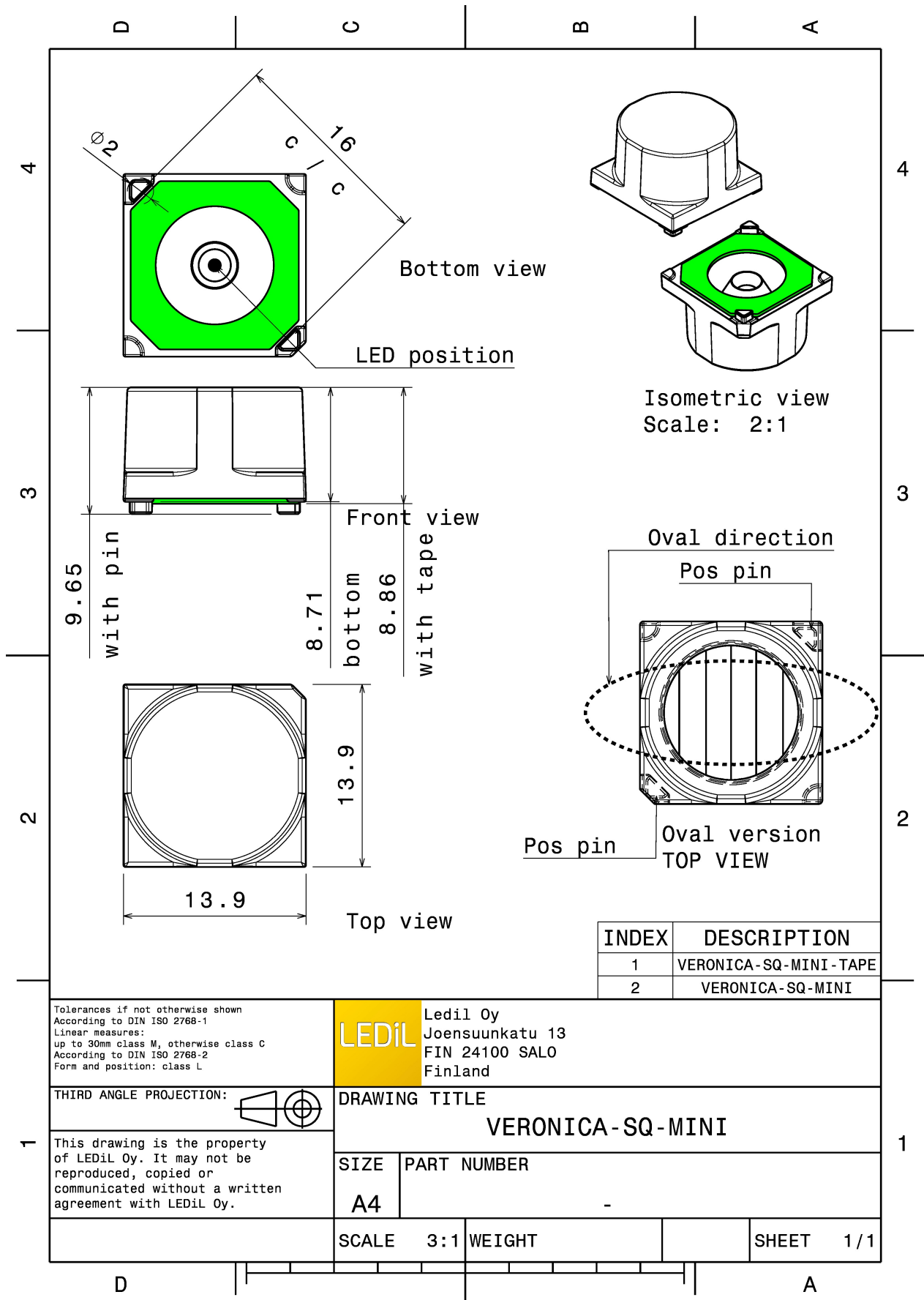

Tolerances if not otherwise shown
According to DIN ISO 2768-1
Linear measures:
up to 30mm class M, otherwise class C
According to DIN ISO 2768-2
Form and position: class L

LEDiL Ledil Oy
Joensuunkatu 13
FIN 24100 SALO
Finland

THIRD ANGLE PROJECTION:

DRAWING TITLE
VERONICA-SQ-MINI

This drawing is the property of LEDiL Oy. It may not be reproduced, copied or communicated without a written agreement with LEDiL Oy.

SIZE	PART NUMBER
A4	-

SCALE	3:1	WEIGHT		SHEET	1/1
-------	-----	--------	--	-------	-----

See also our general installation guide: www.ledil.com/installation_guide

OPTICAL RESULTS (MEASURED):

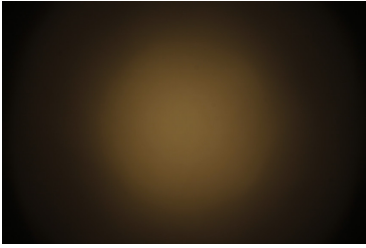
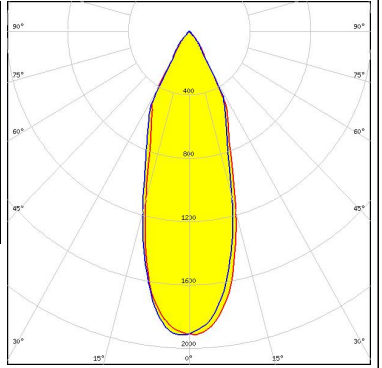
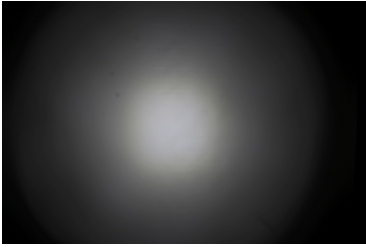
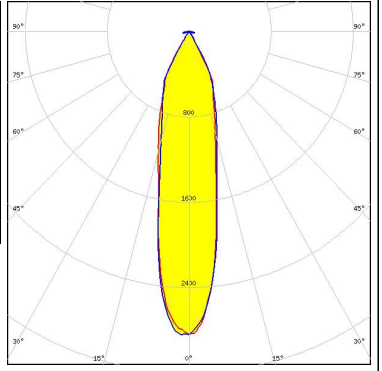
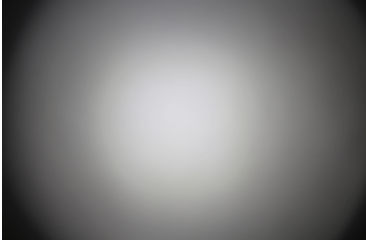
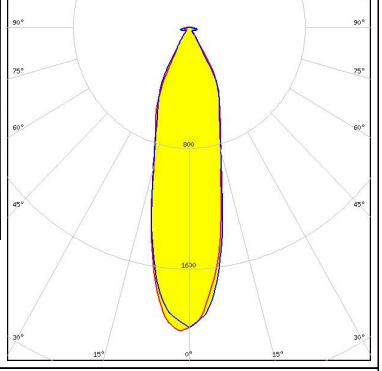
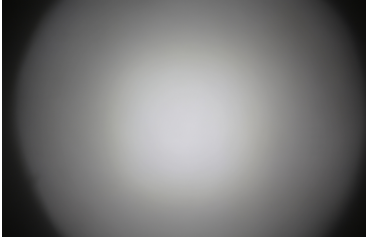
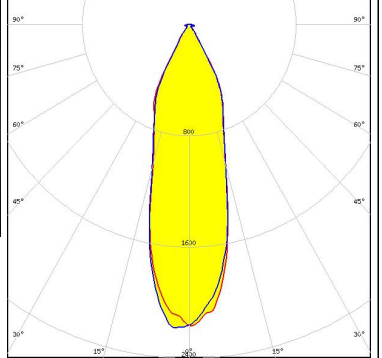
<p>CREE LED</p> <p>LED: XP-G2 FWHM / FWTM: 34.0° / 65.0° Efficiency: 89 % LEDs/each optic: 1 Light colour: White Required components:</p>		
<p>NICHIA</p> <p>LED: NCSxE17A FWHM / FWTM: 23.0° / 59.0° Efficiency: 93 % Peak intensity: 2.8 cd/lm LEDs/each optic: 1 Light colour: White Required components:</p>		
<p>SAMSUNG</p> <p>LED: LH181A FWHM / FWTM: 27.0° / 61.0° Efficiency: 88 % Peak intensity: 2 cd/lm LEDs/each optic: 1 Light colour: White Required components:</p>		
<p>SAMSUNG</p> <p>LED: LH181B FWHM / FWTM: 29.0° / 61.0° Efficiency: 93 % Peak intensity: 2.2 cd/lm LEDs/each optic: 1 Light colour: White Required components:</p>		

OPTICAL RESULTS (MEASURED):



OPTICAL RESULTS (SIMULATED):

CREE LED

LED XP-E2
 FWHM / FWTM 33.0° / 73.0°
 Efficiency 96 %
 Peak intensity 2.1 cd/lm
 LEDs/each optic 1
 Light colour White
 Required components:

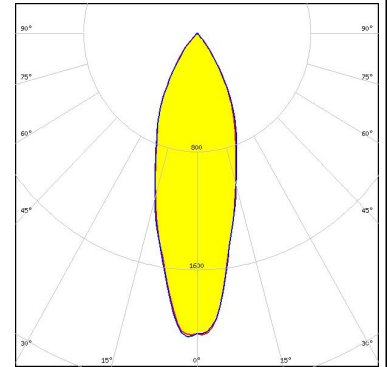

CREE LED

LED XP-G3
 FWHM / FWTM 44.0° / 75.0°
 Efficiency 96 %
 Peak intensity 1.5 cd/lm
 LEDs/each optic 1
 Light colour White
 Required components:

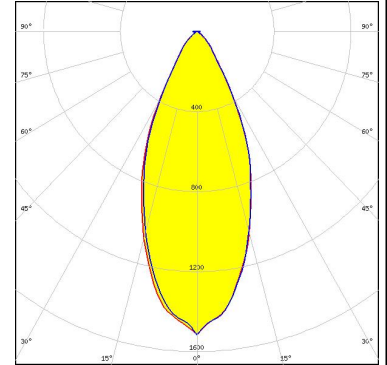

CREE LED

LED XQ-E HI
 FWHM / FWTM 23.0° / 64.0°
 Efficiency 96 %
 Peak intensity 3 cd/lm
 LEDs/each optic 1
 Light colour White
 Required components:

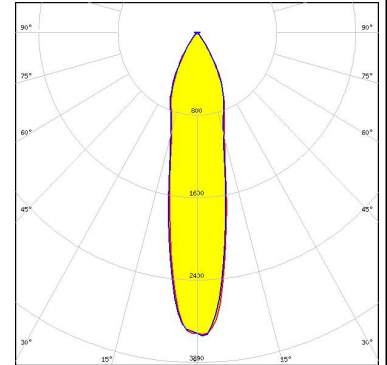

LUMILEDS

LED LUXEON 2835 Line
 FWHM / FWTM 28.0° / 64.0°
 Efficiency 96 %
 Peak intensity 2.6 cd/lm
 LEDs/each optic 1
 Light colour PC Amber
 Required components:

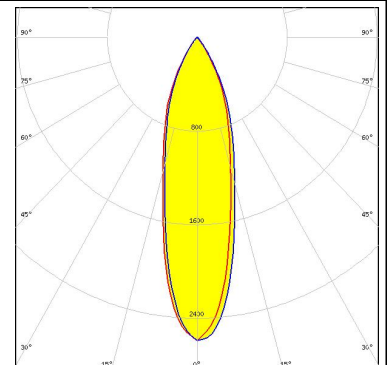

OPTICAL RESULTS (SIMULATED):

LUMILEDS

LED LUXEON 3030 HV
 FWHM / FWTM 33.0° / 64.0°
 Efficiency 95 %
 Peak intensity 2.3 cd/lm
 LEDs/each optic 1
 Light colour White
 Required components:

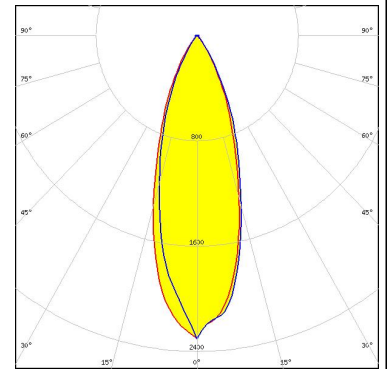

LUMILEDS

LED LUXEON HL1Z
 FWHM / FWTM 24.0° / 58.0°
 Efficiency 95 %
 Peak intensity 3.1 cd/lm
 LEDs/each optic 1
 Light colour White
 Required components:

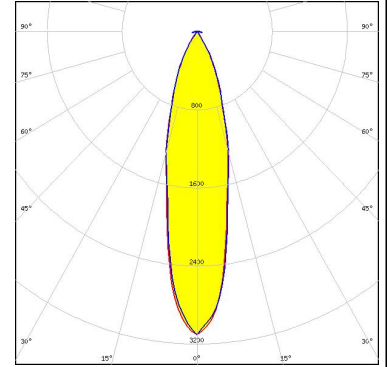

LUMILEDS

LED LUXEON Z ES
 FWHM / FWTM 25.0° / 62.0°
 Efficiency 94 %
 Peak intensity 3 cd/lm
 LEDs/each optic 1
 Light colour White
 Required components:

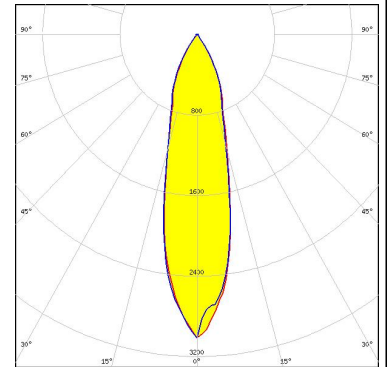

NICHIA

LED NVSxE21A
 FWHM / FWTM 32.0° / 62.0°
 Efficiency 94 %
 Peak intensity 2.3 cd/lm
 LEDs/each optic 1
 Light colour White
 Required components:

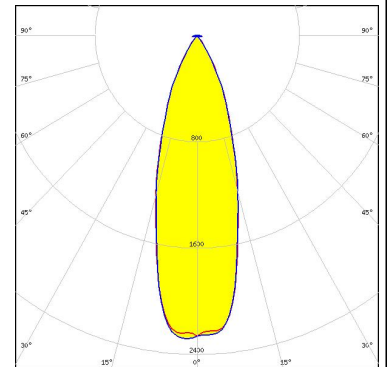

OPTICAL RESULTS (SIMULATED):

OSRAM

Opto Semiconductors

LED OSLOM Square CSSRM2/CSSRM3
 FWHM / FWTM 31.0° / 70.0°
 Efficiency 97 %
 Peak intensity 2 cd/lm
 LEDs/each optic 1
 Light colour White
 Required components:

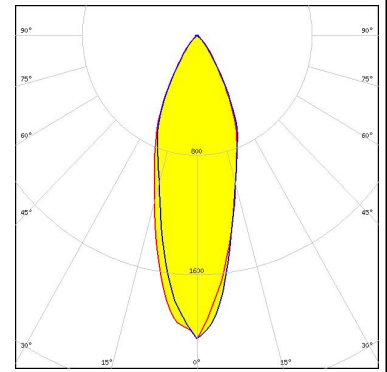

OSRAM

Opto Semiconductors

LED OSLOM SSL 80
 FWHM / FWTM 28.0° / 68.0°
 Efficiency 94 %
 Peak intensity 3.1 cd/lm
 LEDs/each optic 1
 Light colour White
 Required components:

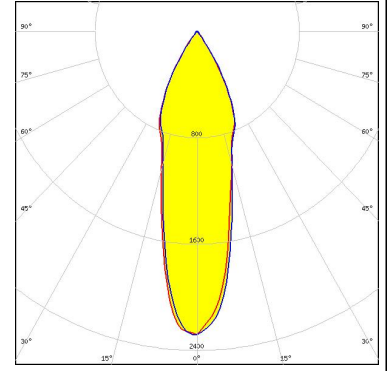

SEOUL SEMICONDUCTOR

LED MJT 3030
 FWHM / FWTM 33.0° / 66.0°
 Efficiency 96 %
 Peak intensity 2.3 cd/lm
 LEDs/each optic 1
 Light colour White
 Required components:

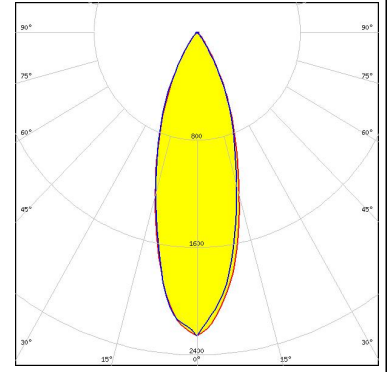

SEOUL SEMICONDUCTOR

LED Z8Y22T
 FWHM / FWTM 38.0° / 66.0°
 Efficiency 94 %
 Peak intensity 1.9 cd/lm
 LEDs/each optic 1
 Light colour White
 Required components:

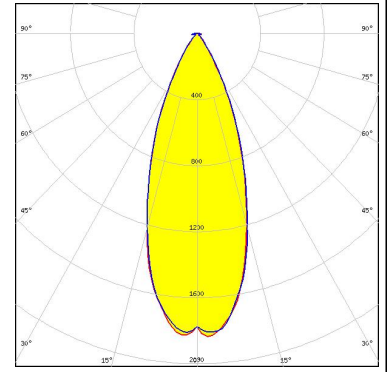

GENERAL INFORMATION:

NOTE: The typical beam angle will be changed by different color, chip size and chip position tolerance. The typical total beam angle is the full angle measured where the luminous intensity is half of the peak value.

MATERIALS:

As part of our continuous research and improvement processes, and to ensure the best possible quality and availability of our products, LEDiL reserves the right to change material grades without notice.

PRODUCT DATA USER AGREEMENT AND DISCLAIMER:

The measured data in the provided downloadable LEDiL Product Datasheets and Mechanical 2D-Drawings is rounded and provided as reference for planning. LEDiL Oy's optical specifications have been verified by conducting performance testing of the products in accordance with the company's quality system. The reported data are averaged results of multiple measurements with typical variation. LEDiL Oy reserves the right to without prior notification make changes and improvements to its products.

LEDiL Oy assumes neither warranty, nor guarantee nor any other liability of any kind for the contents and correctness of the provided data. The provided data has been generated with highest diligence but the provided data may in reality not represent the complete possible variation range of all intrinsic parameters. Therefore, in certain cases a deviation from the provided data could occur.

LEDiL Oy reserves the right to undertake technical changes of its products without further notification which could lead to changes in the provided data. LEDiL Oy assumes no liability of any kind for the possible deviation from any provided data or any other damage resulting from the usage of the provided data.

The user agrees to this disclaimer and user agreement with the download or usage of the provided files.

LEDiL Oy

Joensuunkatu 13
FI-24240 SALO
Finland

LEDiL Inc.

228 West Page Street
Suite D
Sycamore IL 60178
USA

Ledil Optics Technology (Shenzhen) Co., Ltd.

405 , Block B
Casic Motor Building
Shenzhen 518057
P.R.CHINA

Local sales and technical support

[www.ledil.com/
where_to_buy](http://www.ledil.com/where_to_buy)

Shipping locations

Salo, Finland
Hong Kong, China

Distribution Partners

[www.ledil.com/
where_to_buy](http://www.ledil.com/where_to_buy)