

Specification Sheet

Part Number: 151-02003

One-piece ratchet closure allows for easy installation during pre- or final assembly.

Easy release feature simplifies quick adjustments and maintenance.

Impact modified, heat and UV stabilized PA66 provides long-term durability, indoors and out.

Stainless-steel mounting plate tolerates high torque and provides superior corrosion resistance against chemicals, salt spray and contact with dissimilar metals.

Angled mounting plates are ideal for stacking RPCs or for avoiding obstructions or heat sources.

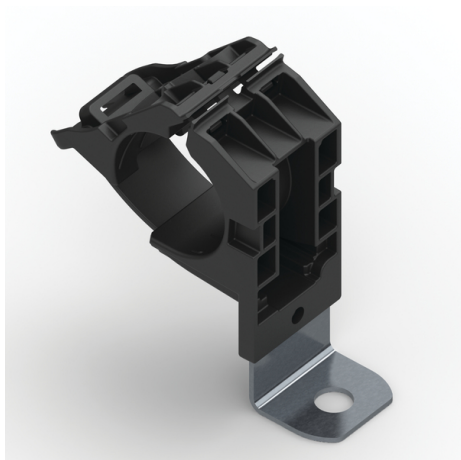

Ratchet P-Clamp, 0.76 - 1.42" Bundle Dia, 90° Short, 0.51" Hole Dia, PA66HIRHSUV/SS304, Black, 160/ctn

Article Number	151-02003
Type	RCC90SM12SS
Color	Black (BK)
Quantity Per	carton

Product Description	The Ratchet P-Clamp family offers versatility when managing wires, cables and hoses. The robust design and durable materials make it ideal for heavy duty applications, both indoors and out. The one-piece adjustable clamp can be closed by hand to the desired diameter. The release feature provides easy and nondestructive removal of cables simply by using a flat-head screwdriver. This nondestructive release allows the clamp to be reused without removing or replacing any bolts or screws.
Short Description	Ratchet P-Clamp, 0.76 - 1.42" Bundle Dia, 90° Short, 0.51" Hole Dia, PA66HIRHSUV/SS304, Black, 160/ctn
Global Part Name	RCC90SM12SS-PA66HIRHSUV/SS304-BK
Minimum Tensile Strength (Imperial)	100.0
Minimum Tensile Strength (Metric)	445.0
Length L (Imperial)	5.58
Length L (Metric)	141.8
Fixation Method	Screw Mounting
Variant	Short
Width W (Imperial)	1.37
Width W (Metric)	34.9
Bundle Diameter Min (Imperial)	0.76
Bundle Diameter Min (Metric)	19.4

Bundle Diameter Max (Imperial)	1.42
Bundle Diameter Max (Metric)	36.0
Cable Tie Width Max (Imperial)	0.52
Cable Tie Width Max (Metric)	13.2
Mounting Hole Diameter D (Imperial)	0.510
Mounting Hole Diameter D (Metric)	12.95 mm
Mounting Hole Diameter D Max (Metric)	12.95
Stud Diameter (Metric)	M12
Mounting Hole Centers (Imperial)	1.57
Material	Polyamide 6.6 high impact modified, heat and UV stabilized (PA66HIRHSUV) Stainless Steel (SS304)
Material Shortcut	PA66HIRHSUV SS304
Flammability	UL 94 HB
Halogen Free	Yes
UV Resistant (Yes/No)	Yes
Operating Temperature	-40°F to +221°F (-40°C to +105°C)

Reach Compliant (Article 33)	No
ROHS Compliant	Yes
UL Listed (US and Canada)	Yes
UL Listed (US)	Yes
Package Quantity (Imperial)	160
Package Quantity (Metric)	160
Customs Number	3926909988

About HellermannTyton

HellermannTyton is a global manufacturer of cable management and identification solutions for automotive, solar, electrical, construction, industrial automation, broadband and other OEM markets. The company's integrated approach to product design, sustainability, production, quality assurance and delivery is optimized to benefit local and global customers. HellermannTyton operates in 39 countries, with North American headquarters in Milwaukee, Wisconsin. (www.hellermann.tyton.com).

© 2023 HellermannTyton. All Rights Reserved.

[Contact Us](#)

[RoHS/WEEE Compliance](#)

[Disclaimer](#)

[Terms and Conditions](#)