

## ANGELETTE-WW-B

~60° wide beam compatible with BJB and B+W connectors

### SPECIFICATION:

Dimensions	Ø 110.0 mm
Height	57.3 mm
Fastening	socket
ROHS compliant	yes ⓘ



### MATERIALS:

Component	Type	Material	Colour	Finish	Coating
ANGELETTE-WW-B	Reflector	PC	metal		

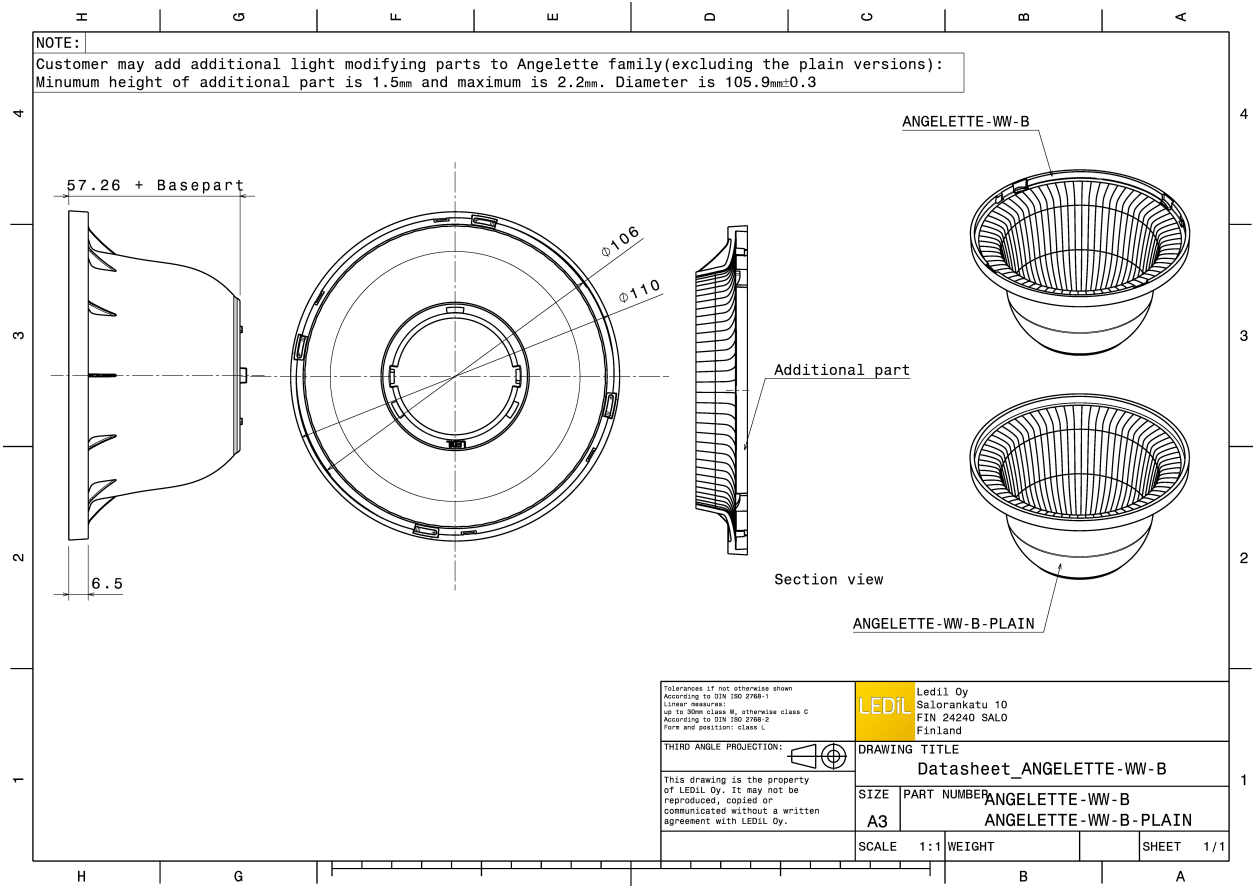

### ORDERING INFORMATION:

Component	Qty in box	MOQ	MPQ	Box weight (kg)
F14618_ANGELETTE-WW-B » Box size: 398 x 298 x 265 mm	120	90	30	5.2





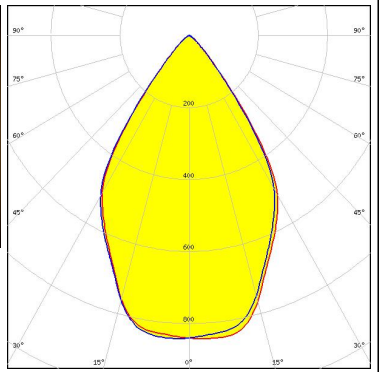
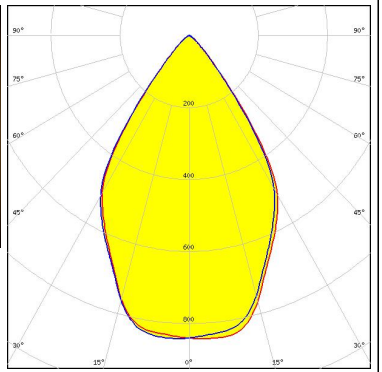
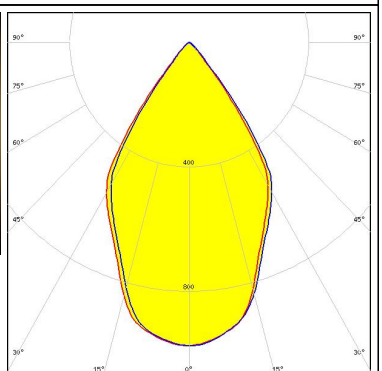

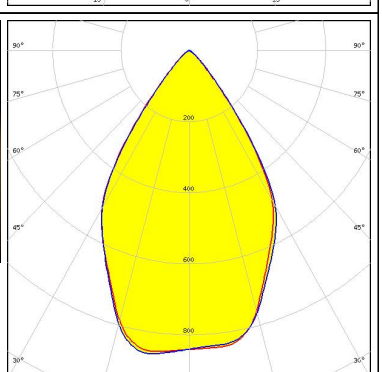
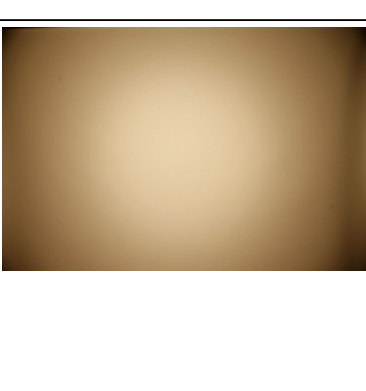
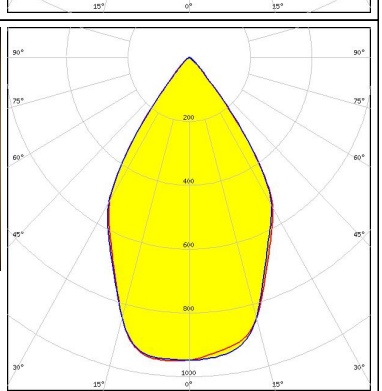

See also our general installation guide: [www.ledil.com/installation\\_guide](http://www.ledil.com/installation_guide)

#### OPTICAL RESULTS (MEASURED):

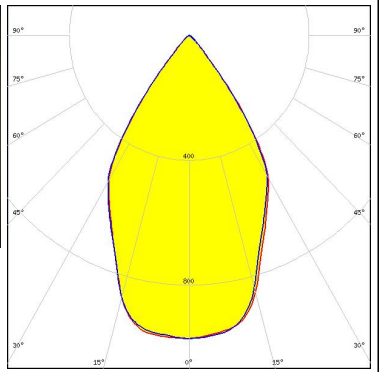
<p>bridgelux.</p> <p>LED V15 Gen6</p> <p>FWHM / FWTM 66.0° / 88.0°</p> <p>Efficiency 85 %</p> <p>Peak intensity 0.9 cd/lm</p> <p>LEDs/each optic 1</p> <p>Light colour White</p> <p>Required components: F13671_ANGE-RZ-LENS BJB: 47.319.2224</p>		
<p>bridgelux.</p> <p>LED V15 Gen6</p> <p>FWHM / FWTM 65.0° / 83.0°</p> <p>Efficiency 89 %</p> <p>Peak intensity 1 cd/lm</p> <p>LEDs/each optic 1</p> <p>Light colour White</p> <p>Required components: BJB: 47.319.2224</p>		
<p>bridgelux.</p> <p>LED V18 Gen6</p> <p>FWHM / FWTM 65.0° / 88.0°</p> <p>Efficiency 86 %</p> <p>Peak intensity 0.9 cd/lm</p> <p>LEDs/each optic 1</p> <p>Light colour White</p> <p>Required components: F13671_ANGE-RZ-LENS BJB: 47.319.2274</p>		
<p>bridgelux.</p> <p>LED V18 Gen6</p> <p>FWHM / FWTM 64.0° / 83.0°</p> <p>Efficiency 89 %</p> <p>Peak intensity 1 cd/lm</p> <p>LEDs/each optic 1</p> <p>Light colour White</p> <p>Required components: BJB: 47.319.2274</p>		

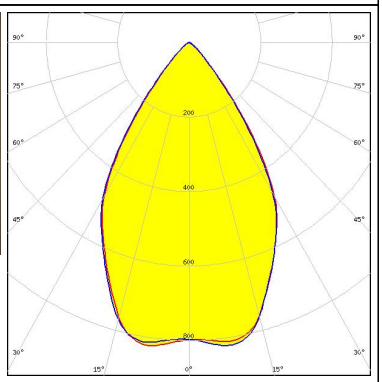
#### OPTICAL RESULTS (MEASURED):

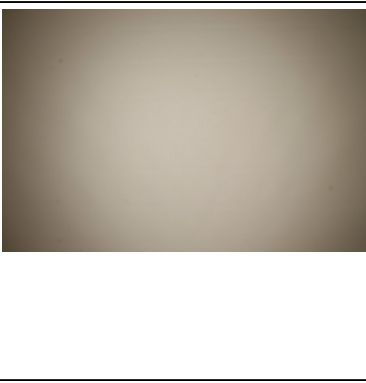
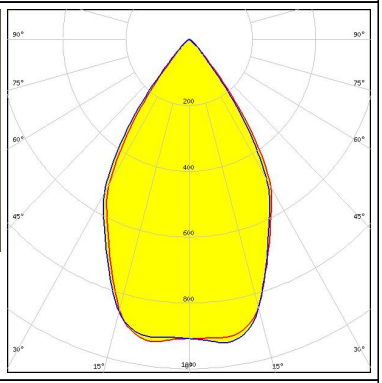
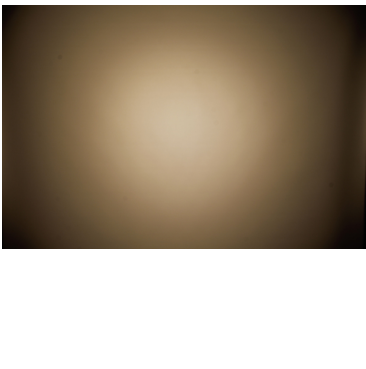
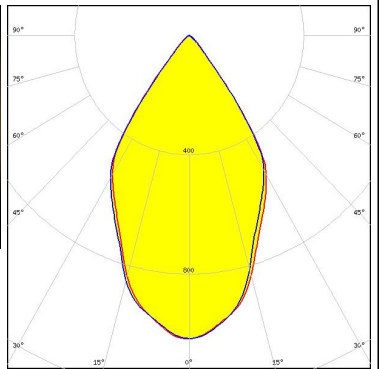
<p></p> <p>LED V18 Gen7            FWHM / FWTM 64.0° / 83.0°            Efficiency 89 %            Peak intensity 1 cd/lm            LEDs/each optic 1            Light colour White            Required components:            BJB: 47.319.2350</p>		
<p></p> <p>LED V22 Gen6            FWHM / FWTM 64.0° / 88.0°            Efficiency 83 %            Peak intensity 0.8 cd/lm            LEDs/each optic 1            Light colour White            Required components:            F13671_ANGE-RZ-LENS            A.A.G. STUCCHI: 8102-G2</p>		
<p></p> <p>LED V22 Gen6            FWHM / FWTM 63.0° / 84.0°            Efficiency 87 %            Peak intensity 0.9 cd/lm            LEDs/each optic 1            Light colour White            Required components:            A.A.G. STUCCHI: 8102-G2</p>		
<p><b>CITIZEN</b></p> <p>LED CLL03x/CLU03x            FWHM / FWTM 63.0° / 82.0°            Efficiency 89 %            Peak intensity 1 cd/lm            LEDs/each optic 1            Light colour White            Required components:            A.A.G. STUCCHI: 8101-G2</p>		



#### OPTICAL RESULTS (MEASURED):

#### CITIZEN

LED CLL03x/CLU03x  
 FWHM / FWTM 65.0° / 87.0°  
 Efficiency 85 %  
 Peak intensity 0.9 cd/lm  
 LEDs/each optic 1  
 Light colour White  
 Required components:  
 F13671\_ANGE-RZ-LENS  
 A.A.G. STUCCHI: 8101-G2

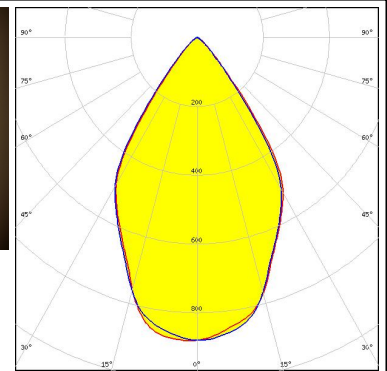
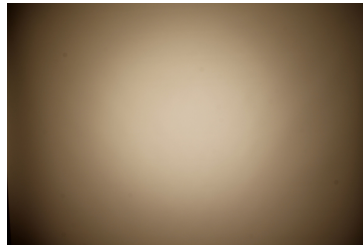

LED CXA/B 1816 & CXA/B 1820 & CXA 1850  
 FWHM / FWTM 62.0° / 81.0°  
 Efficiency 90 %  
 Peak intensity 1 cd/lm  
 LEDs/each optic 1  
 Light colour White  
 Required components:  
 A.A.G. STUCCHI: 8403/G2

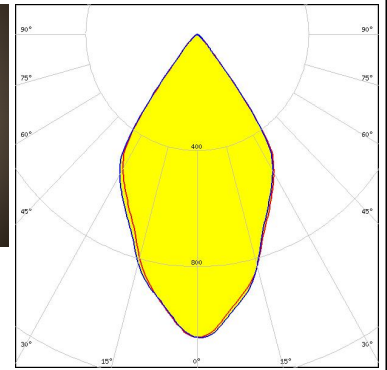
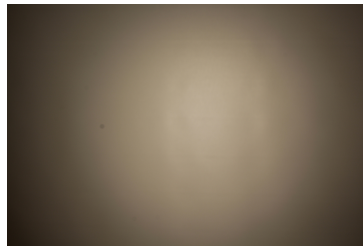

LED CXA/B 25xx  
 FWHM / FWTM 63.0° / 83.0°  
 Efficiency 88 %  
 Peak intensity 1 cd/lm  
 LEDs/each optic 1  
 Light colour White  
 Required components:  
 A.A.G. STUCCHI: 8401-G2

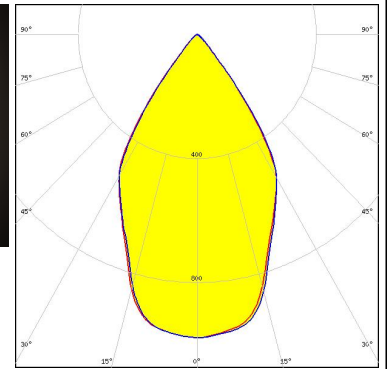
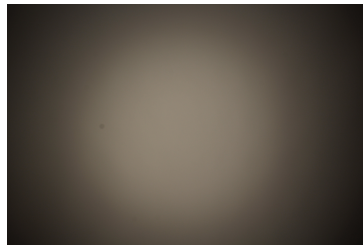

LED LUXEON CoB 1208  
 FWHM / FWTM 63.0° / 82.0°  
 Efficiency 89 %  
 Peak intensity 1 cd/lm  
 LEDs/each optic 1  
 Light colour White  
 Required components:  
 A.A.G. STUCCHI: 8301-G2

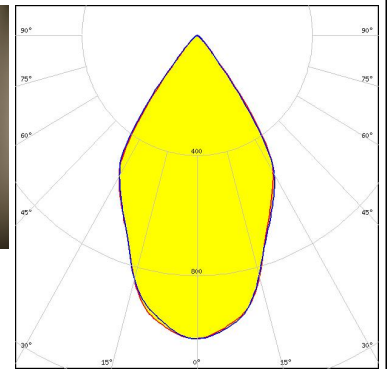
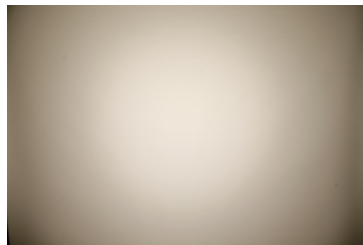

#### OPTICAL RESULTS (MEASURED):

#### LUMILEDS

LED LUXEON CoB 1208  
 FWHM / FWTM 66.0° / 87.0°  
 Efficiency 85 %  
 Peak intensity 0.9 cd/lm  
 LEDs/each optic 1  
 Light colour White  
 Required components:  
 F13671\_ANGE-RZ-LENS  
 A.A.G. STUCCHI: 8301-G2

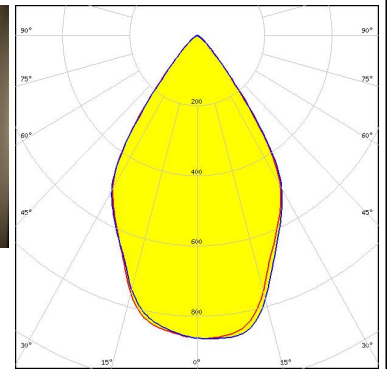

#### LUMILEDS

LED LUXEON CoB 1208  
 FWHM / FWTM 63.0° / 82.0°  
 Efficiency 89 %  
 Peak intensity 1 cd/lm  
 LEDs/each optic 1  
 Light colour White  
 Required components:  
 A.A.G. STUCCHI: 8301-G2

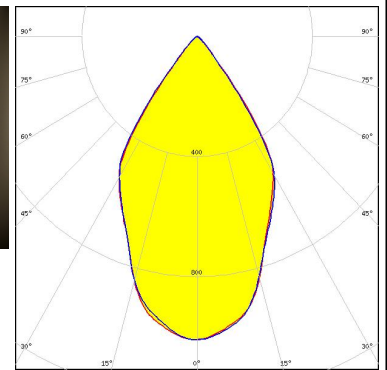
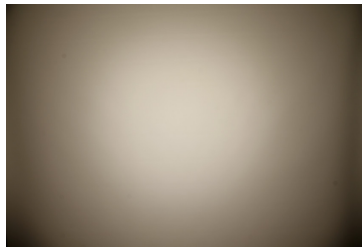

#### PHILIPS

LED Fortimo SLM L19 CoB  
 FWHM / FWTM 65.0° / 87.0°  
 Efficiency 84 %  
 Peak intensity 0.9 cd/lm  
 LEDs/each optic 1  
 Light colour White  
 Required components:  
 F13671\_ANGE-RZ-LENS  
 BJB: 47.319.2030

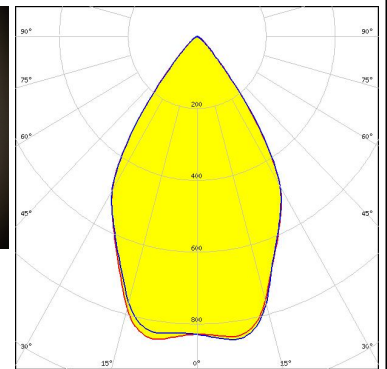

#### PHILIPS

LED Fortimo SLM L19 CoB  
 FWHM / FWTM 63.0° / 83.0°  
 Efficiency 89 %  
 Peak intensity 1 cd/lm  
 LEDs/each optic 1  
 Light colour White  
 Required components:  
 BJB: 47.319.2030

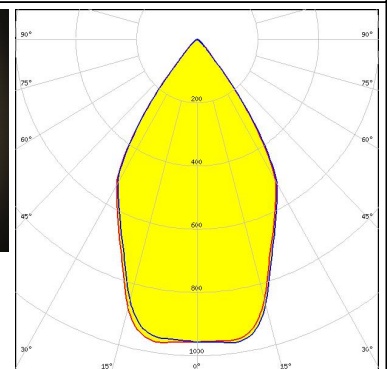
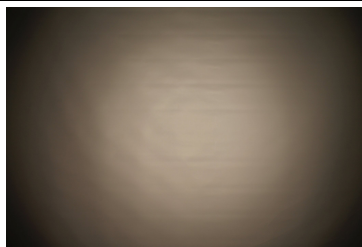

#### OPTICAL RESULTS (MEASURED):

### PHILIPS

LED Fortimo SLM L23 CoB  
 FWHM / FWTM 64.0° / 88.0°  
 Efficiency 84 %  
 Peak intensity 0.8 cd/lm  
 LEDs/each optic 1  
 Light colour White  
 Required components:  
 F13671\_ANGE-RZ-LENS  
 BJB: 47.319.2030

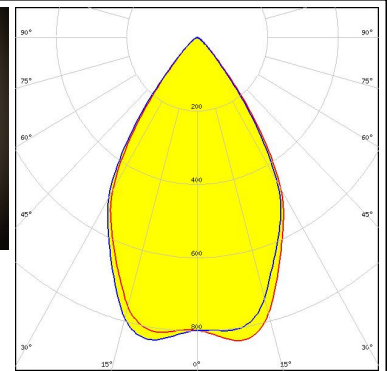

### PHILIPS

LED Fortimo SLM L23 CoB  
 FWHM / FWTM 62.0° / 84.0°  
 Efficiency 88 %  
 Peak intensity 0.9 cd/lm  
 LEDs/each optic 1  
 Light colour White  
 Required components:  
 BJB: 47.319.2030

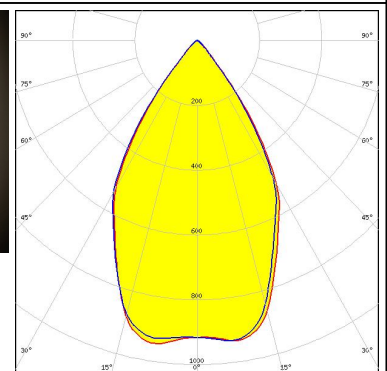
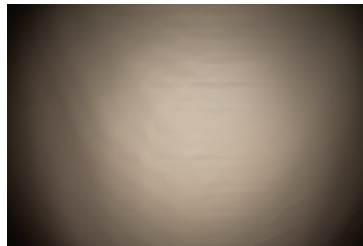

### SAMSUNG

LED LC016D / LC019D / LC026D / LC033D  
 FWHM / FWTM 65.0° / 83.0°  
 Efficiency 90 %  
 Peak intensity 1 cd/lm  
 LEDs/each optic 1  
 Light colour White  
 Required components:  
 BJB: 47.319.2021

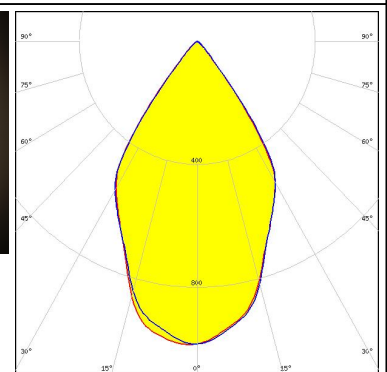
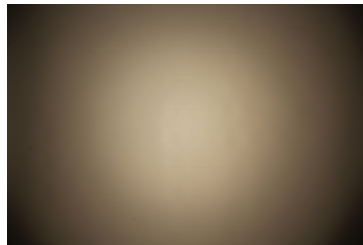

### SAMSUNG

LED LC016D / LC019D / LC026D / LC033D  
 FWHM / FWTM 66.0° / 88.0°  
 Efficiency 86 %  
 Peak intensity 0.9 cd/lm  
 LEDs/each optic 1  
 Light colour White  
 Required components:  
 F13671\_ANGE-RZ-LENS  
 BJB: 47.319.2021

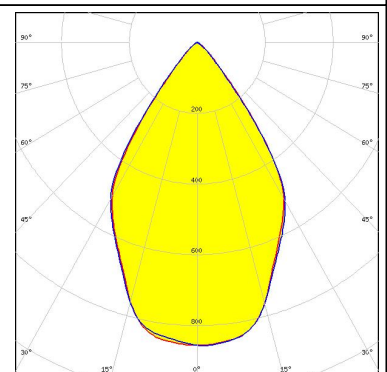

#### OPTICAL RESULTS (MEASURED):

### SAMSUNG

LED LC016D / LC019D / LC026D / LC033D  
 FWHM / FWTM 65.0° / 83.0°  
 Efficiency 90 %  
 Peak intensity 1 cd/lm  
 LEDs/each optic 1  
 Light colour White  
 Required components:  
 A.A.G. STUCCHI: 8101-G2

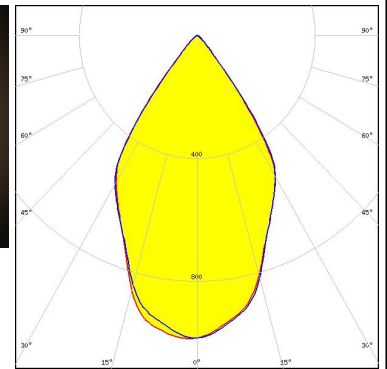
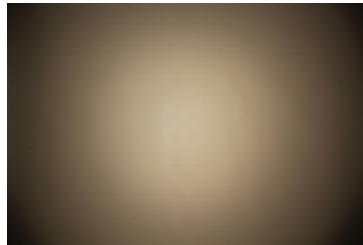

### SAMSUNG

LED LC016D / LC019D / LC026D / LC033D  
 FWHM / FWTM 66.0° / 88.0°  
 Efficiency 86 %  
 Peak intensity 0.9 cd/lm  
 LEDs/each optic 1  
 Light colour White  
 Required components:  
 F13671\_ANGE-RZ-LENS  
 A.A.G. STUCCHI: 8101-G2

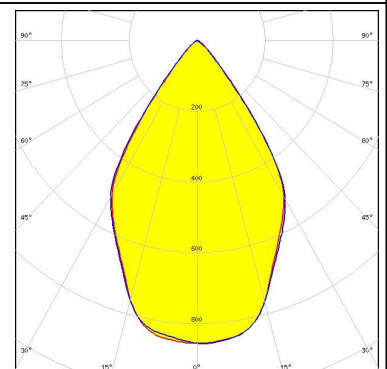
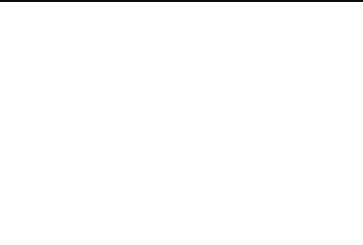

### TRIDONIC

LED SLE G7 LES15  
 FWHM / FWTM 63.0° / 82.0°  
 Efficiency 90 %  
 Peak intensity 1 cd/lm  
 LEDs/each optic 1  
 Light colour White  
 Required components:  
 BJB: 47.319.2021

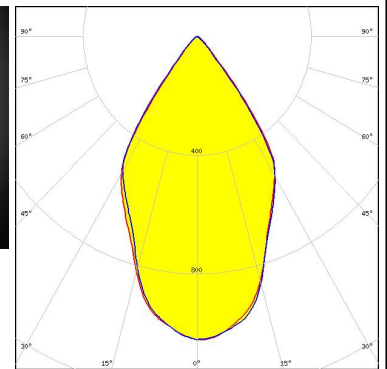
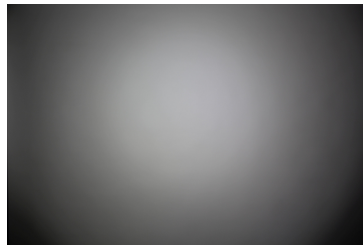

### TRIDONIC

LED SLE G7 LES17 H  
 FWHM / FWTM 59.0° / 81.0°  
 Efficiency 88 %  
 Peak intensity 1.1 cd/lm  
 LEDs/each optic 1  
 Light colour White  
 Required components:

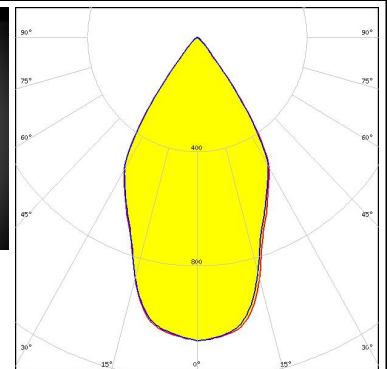

#### OPTICAL RESULTS (MEASURED):

#### TRIDONIC

LED SLE G7 LES21 H  
FWHM / FWTM 61.0° / 82.0°  
Efficiency 88 %  
Peak intensity 1 cd/lm  
LEDs/each optic 1  
Light colour White  
Required components:

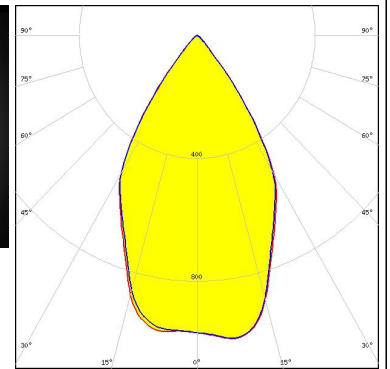

#### XICATO

LED XOB 14.5 mm  
FWHM / FWTM 64.0° / 82.0°  
Efficiency 91 %  
Peak intensity 1 cd/lm  
LEDs/each optic 1  
Light colour White  
Required components:  
BJB: 47.319.2021

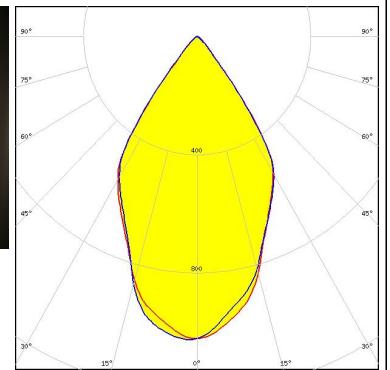
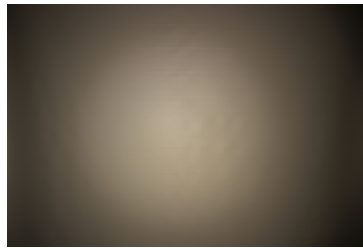



#### OPTICAL RESULTS (SIMULATED):

#### CITIZEN

LED CLL03x/CLU03x  
 FWHM / FWTM 54.0° / 80.0°  
 Efficiency 89 %  
 Peak intensity 1.2 cd/lm  
 LEDs/each optic 1  
 Light colour White  
 Required components:  
 BJB: 47.319.2021

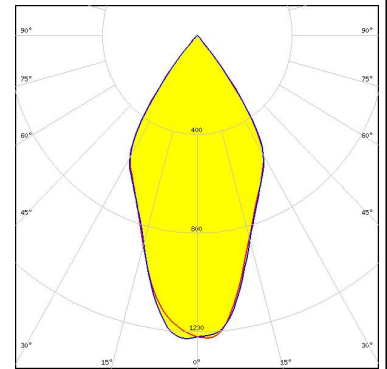

#### CITIZEN

LED CLL04x/CLU04x  
 FWHM / FWTM 58.0° / 81.0°  
 Efficiency 88 %  
 Peak intensity 1.1 cd/lm  
 LEDs/each optic 1  
 Light colour White  
 Required components:  
 BJB: 47.319.2030

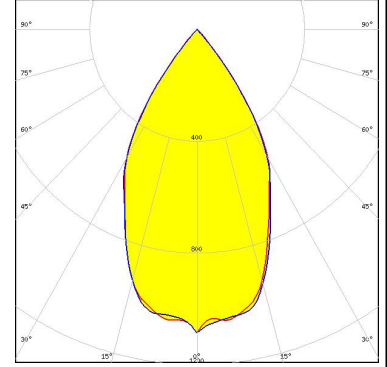

#### SAMSUNG

LED LC040D / LC060D / LC080D  
 FWHM / FWTM 60.0° / 81.0°  
 Efficiency 87 %  
 Peak intensity 1 cd/lm  
 LEDs/each optic 1  
 Light colour White  
 Required components:  
 BJB: 47.319.2030

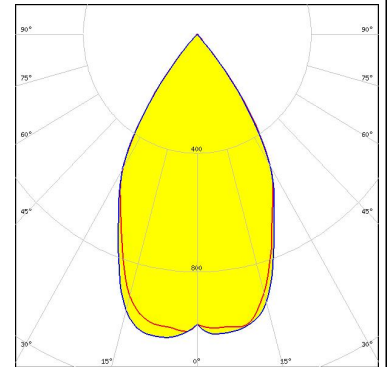

#### TRIDONIC

LED SLE G7 LES21 H  
 FWHM / FWTM 56.0° / 78.0°  
 Efficiency 84 %  
 Peak intensity 1.1 cd/lm  
 LEDs/each optic 1  
 Light colour White  
 Required components:  
 F15412\_ANGELETTE-DL

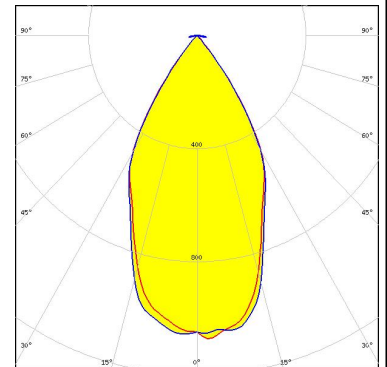



#### GENERAL INFORMATION:

NOTE: The typical beam angle will be changed by different color, chip size and chip position tolerance. The typical total beam angle is the full angle measured where the luminous intensity is half of the peak value.

Due to use of high power COB's with this product, special attention to proper thermal design is highly recommended. LEDiL has no liability for direct, indirect or consecutive damages arising from the LEDiL products being used outside of the recommended temperature range.

#### MATERIALS:

As part of our continuous research and improvement processes, and to ensure the best possible quality and availability of our products, LEDiL reserves the right to change material grades without notice.

#### PRODUCT DATA USER AGREEMENT AND DISCLAIMER:

The measured data in the provided downloadable LEDiL Product Datasheets and Mechanical 2D-Drawings is rounded and provided as reference for planning. LEDiL Oy's optical specifications have been verified by conducting performance testing of the products in accordance with the company's quality system. The reported data are averaged results of multiple measurements with typical variation. LEDiL Oy reserves the right to without prior notification make changes and improvements to its products.

LEDiL Oy assumes neither warranty, nor guarantee nor any other liability of any kind for the contents and correctness of the provided data. The provided data has been generated with highest diligence but the provided data may in reality not represent the complete possible variation range of all intrinsic parameters. Therefore, in certain cases a deviation from the provided data could occur.

LEDiL Oy reserves the right to undertake technical changes of its products without further notification which could lead to changes in the provided data. LEDiL Oy assumes no liability of any kind for the possible deviation from any provided data or any other damage resulting from the usage of the provided data.

The user agrees to this disclaimer and user agreement with the download or usage of the provided files.

#### LEDiL Oy

Joensuunkatu 13  
FI-24240 SALO  
Finland

#### LEDiL Inc.

228 West Page Street  
Suite D  
Sycamore IL 60178  
USA

#### Ledil Optics Technology (Shenzhen) Co., Ltd.

# 405 , Block B  
Casic Motor Building  
Shenzhen 518057  
P.R.CHINA

#### Local sales and technical support

[www.ledil.com/  
where\\_to\\_buy](http://www.ledil.com/where_to_buy)

#### Shipping locations

Salo, Finland  
Hong Kong, China

#### Distribution Partners

[www.ledil.com/  
where\\_to\\_buy](http://www.ledil.com/where_to_buy)