

VERONICA-SQ-MINI-O

~15° + 50° oval beam

SPECIFICATION:

| | |
|----------------|----------------|
| Dimensions | 13.9 x 13.9 mm |
| Height | 8.9 mm |
| Fastening | tape, pin |
| ROHS compliant | yes ⓘ |

MATERIALS:

| Component | Type | Material | Colour | Finish |
|-----------------------|-------------|--------------|--------|--------|
| VERONICA-SQ-MINI-O | Single lens | PMMA | clear | |
| VERONICA-SQ-MINI-TAPE | Tape | Acrylic foam | clear | |



ORDERING INFORMATION:

| Component | Type | Qty in box | MOQ | MPQ | Box weight (kg) |
|--|-------------|------------|-----|-----|-----------------|
| CA14602_VERONICA-SQ-MINI-O » Box size: 480 x 280 x 300 mm | Single lens | 5544 | 252 | 252 | 7.8 |

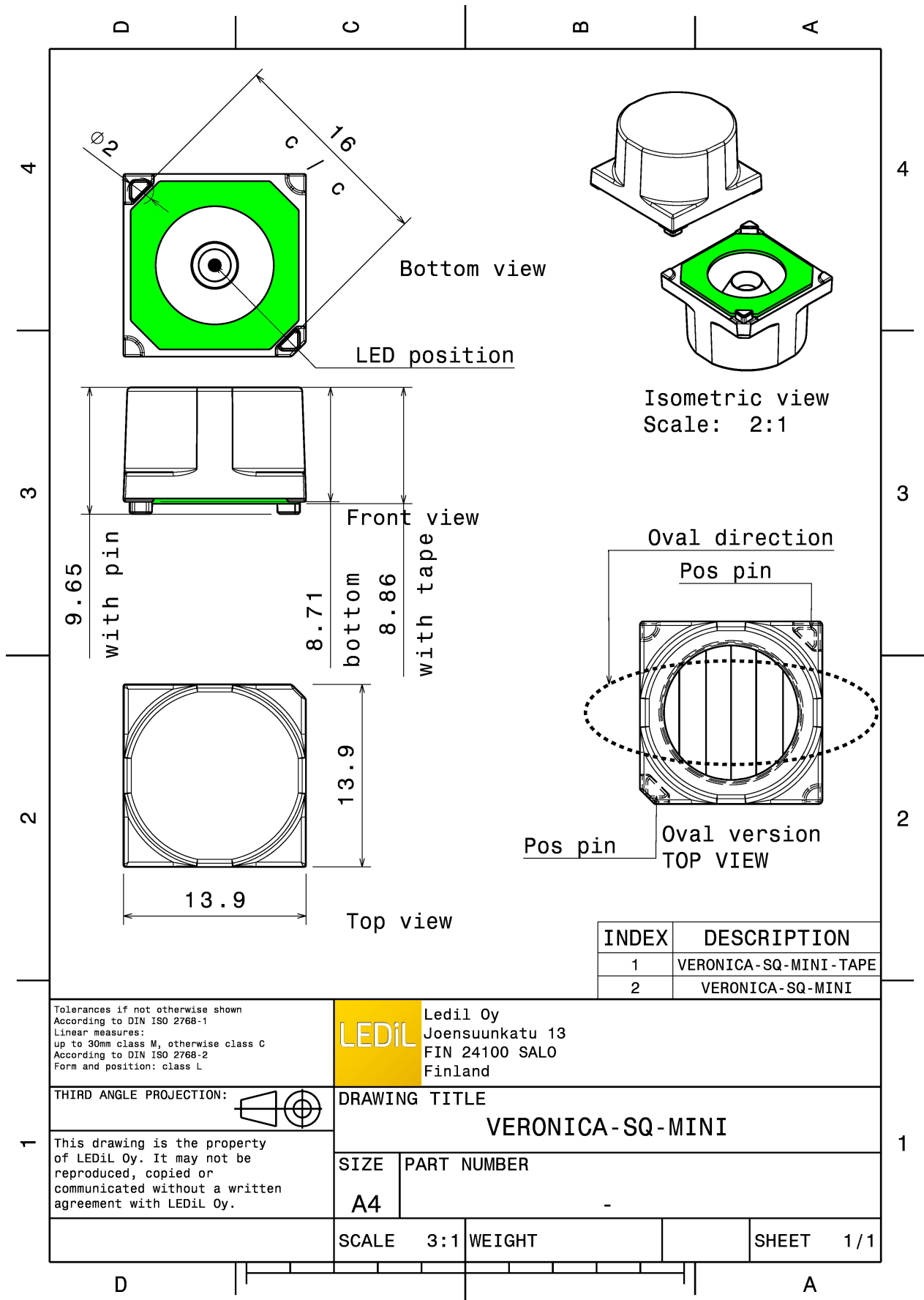

Tolerances if not otherwise shown
According to DIN ISO 2768-1
Linear measures:
up to 30mm class M, otherwise class C
According to DIN ISO 2768-2
Form and position: class L



Ledil Oy
Joensuunkatu 13
FIN 24100 SALO
Finland

THIRD ANGLE PROJECTION:

DRAWING TITLE

VERONICA-SQ-MINI

This drawing is the property of LEDiL Oy. It may not be reproduced, copied or communicated without a written agreement with LEDiL Oy.

SIZE PART NUMBER

A4 -

SCALE 3:1 WEIGHT

SHEET 1/1

See also our general installation guide: www.ledil.com/installation_guide

OPTICAL RESULTS (MEASURED):

CREE LED

LED XD16
 FWHM / FWTM 41.0 + 18.0° / 68.0 + 43.0°
 Efficiency 89 %
 Peak intensity 2.2 cd/lm
 LEDs/each optic 1
 Light colour White
 Required components:

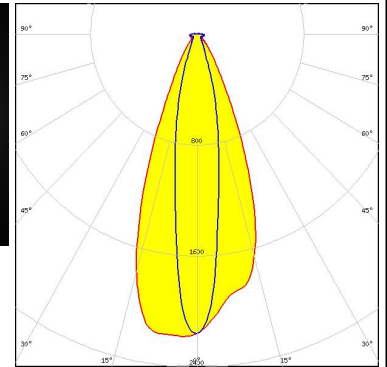

CREE LED

LED XP-E2
 FWHM / FWTM 42.0 + 14.0° / 61.0 + 34.0°
 Efficiency 92 %
 Peak intensity 3.8 cd/lm
 LEDs/each optic 1
 Light colour White
 Required components:

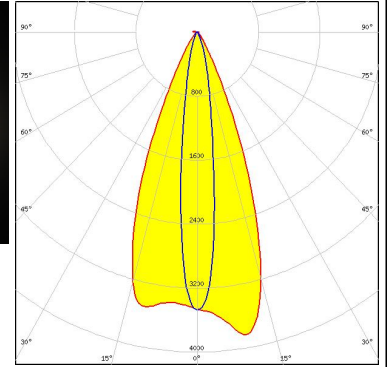

LUMILEDS

LED LUXEON Rebel
 FWHM / FWTM 42.0 + 20.0° / 71.0 + 50.0°
 Efficiency 90 %
 Peak intensity 2.1 cd/lm
 LEDs/each optic 1
 Light colour White
 Required components:

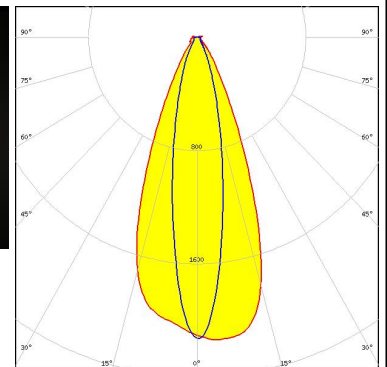
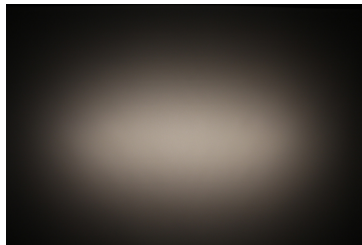

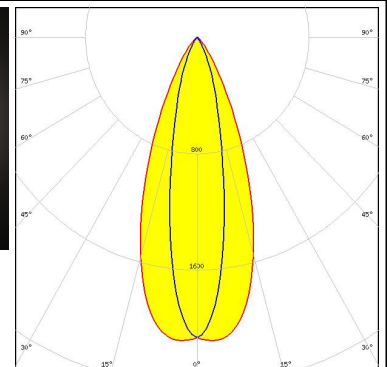
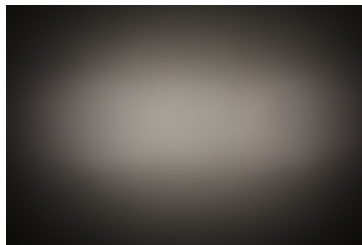

LUMILEDS

LED LUXEON Rebel ES
 FWHM / FWTM 50.0 + 23.0° / 71.0 + 51.0°
 Efficiency 80 %
 Peak intensity 2.1 cd/lm
 LEDs/each optic 1
 Light colour White
 Required components:

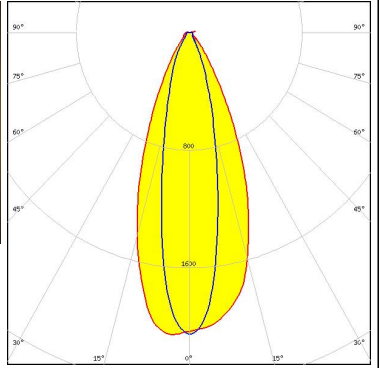

OPTICAL RESULTS (MEASURED):

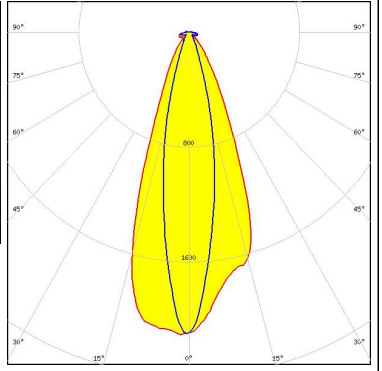
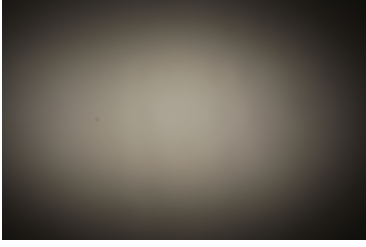
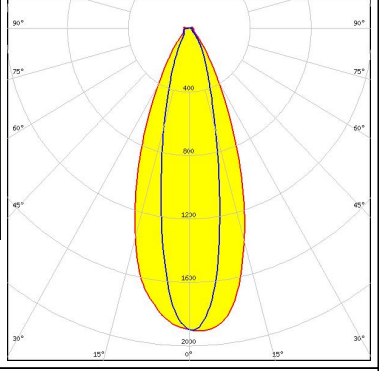
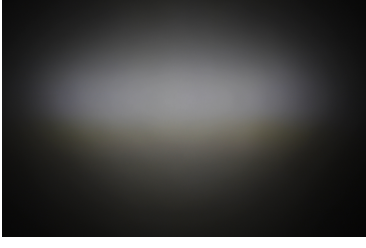
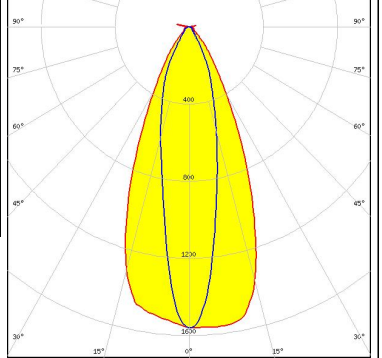
| | | |
|---|--|---|
| <p>LUMILEDS</p> <p>LED LUXEON TX</p> <p>FWHM / FWTM 42.0 + 22.0° / 73.0 + 54.0°</p> <p>Efficiency 90 %</p> <p>Peak intensity 2.1 cd/lm</p> <p>LEDs/each optic 1</p> <p>Light colour White</p> <p>Required components:</p> |  |  |
| <p>NICHIA</p> <p>LED NCSxE17A</p> <p>FWHM / FWTM 40.0 + 20.0° / 69.0 + 44.0°</p> <p>Efficiency 89 %</p> <p>Peak intensity 2.1 cd/lm</p> <p>LEDs/each optic 1</p> <p>Light colour White</p> <p>Required components:</p> |  |  |
| <p>NICHIA</p> <p>LED NVSxx19B/NVSxx19C</p> <p>FWHM / FWTM 41.0 + 23.0° / 74.0 + 56.0°</p> <p>Efficiency 90 %</p> <p>Peak intensity 1.9 cd/lm</p> <p>LEDs/each optic 1</p> <p>Light colour White</p> <p>Required components:</p> |  |  |
| <p>OSRAM Opto Semiconductors</p> <p>LED Duris S5 (2 chip)</p> <p>FWHM / FWTM 76.0 + 22.0° / 79.0 + 61.0°</p> <p>Efficiency 74 %</p> <p>Peak intensity 1.6 cd/lm</p> <p>LEDs/each optic 1</p> <p>Light colour White</p> <p>Required components:</p> |  |  |

OPTICAL RESULTS (MEASURED):

OSRAM

Opto Semiconductors

LED OSLON Square EC
 FWHM / FWTM 42.0 + 20.0° / 72.0 + 49.0°
 Efficiency 89 %
 Peak intensity 2.2 cd/lm
 LEDs/each optic 1
 Light colour White
 Required components:

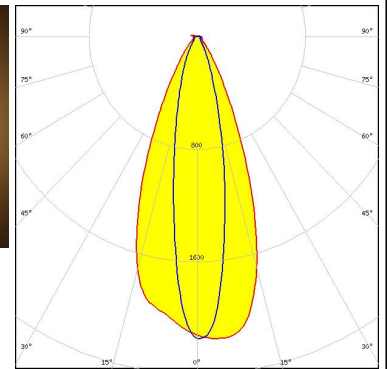

OSRAM

Opto Semiconductors

LED SFH 4170S
 FWHM / FWTM 40.0 + 12.0° / 60.0 + 33.0°
 Efficiency %
 LEDs/each optic 1
 Light colour IR
 Required components:

OSRAM

Opto Semiconductors

LED SFH 4180S
 FWHM / FWTM 38.0 + 11.0° / 58.0 + 31.0°
 Efficiency %
 LEDs/each optic 1
 Light colour IR
 Required components:

SAMSUNG

LED LH181A
 FWHM / FWTM 42.0 + 22.0° / 77.0 + 54.0°
 Efficiency 88 %
 Peak intensity 1.5 cd/lm
 LEDs/each optic 1
 Light colour White
 Required components:

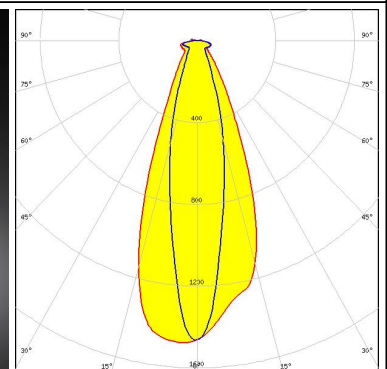
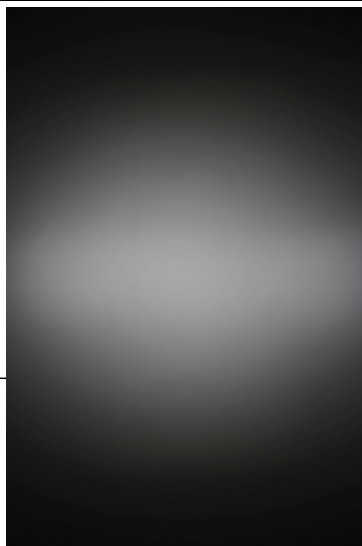

OPTICAL RESULTS (MEASURED):

SAMSUNG

LED LH181B
 FWHM / FWTM 22.0 + 41.0° / 54.0 + 75.0°
 Efficiency 91 %
 Peak intensity 1.8 cd/lm
 LEDs/each optic 1
 Light colour White
 Required components:

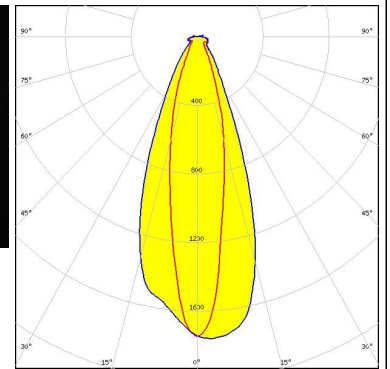
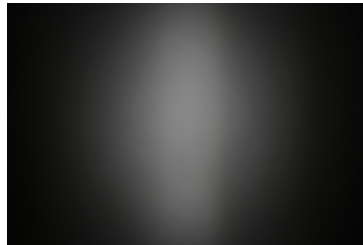

SEOUL SEMICONDUCTOR

LED Z8Y22P
 FWHM / FWTM 46.0 + 23.0° / 80.0 + 62.0°
 Efficiency 90 %
 Peak intensity 1.5 cd/lm
 LEDs/each optic 1
 Light colour White
 Required components:

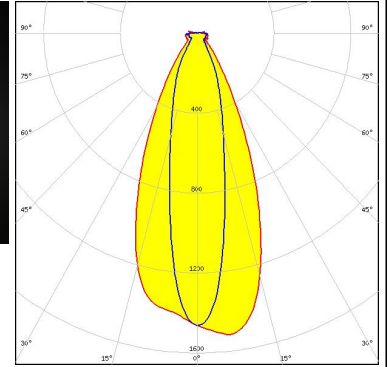

OPTICAL RESULTS (SIMULATED):

CREE LED

LED XP-G2 HE
 FWHM / FWTM 50.0 + 26.0° / 88.0 + 59.0°
 Efficiency 90 %
 Peak intensity 1.6 cd/lm
 LEDs/each optic 1
 Light colour White
 Required components:

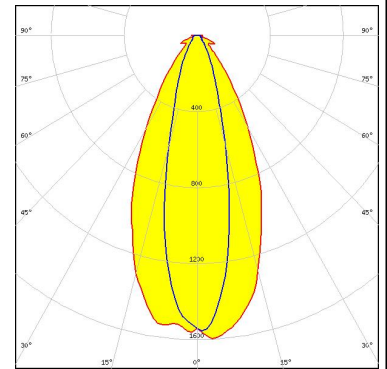

CREE LED

LED XQ-E HD
 FWHM / FWTM 54.0 + 16.0° / 80.0 + 34.0°
 Efficiency 90 %
 Peak intensity 2.7 cd/lm
 LEDs/each optic 1
 Light colour White
 Required components:

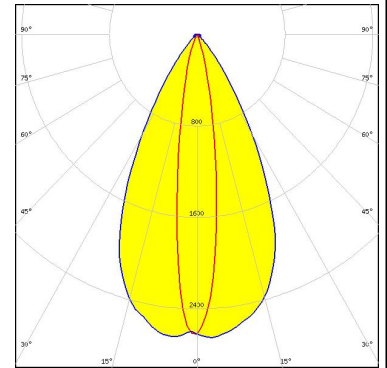

CREE LED

LED XQ-E HI
 FWHM / FWTM 54.0 + 12.0° / 78.0 + 26.0°
 Efficiency 89 %
 Peak intensity 3.3 cd/lm
 LEDs/each optic 1
 Light colour White
 Required components:

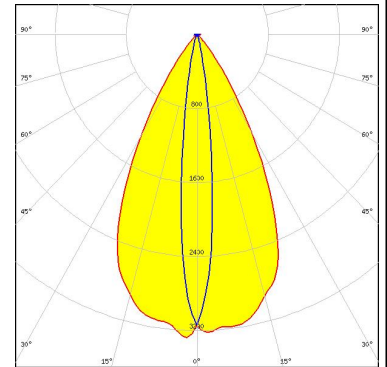

LUMILEDS

LED LUXEON 2835 Line
 FWHM / FWTM 54.0 + 16.0° / 80.0 + 41.0°
 Efficiency 86 %
 Peak intensity 2.3 cd/lm
 LEDs/each optic 1
 Light colour PC Amber
 Required components:

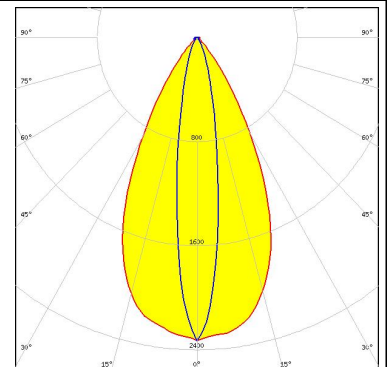

OPTICAL RESULTS (SIMULATED):

LUMILEDS

LED LUXEON 5050 Round LES
 FWHM / FWTM 54.0 + 36.0° / 118.0 + 106.0°
 Efficiency 86 %
 Peak intensity 0.8 cd/lm
 LEDs/each optic 1
 Light colour White
 Required components:

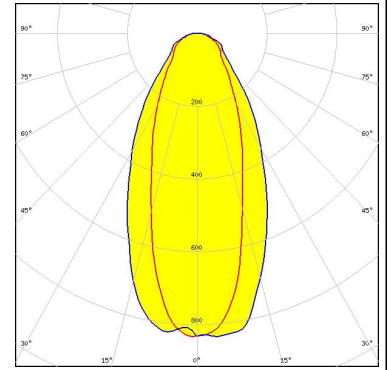

LUMILEDS

LED LUXEON C
 FWHM / FWTM 53.0 + 17.0° / 81.0 + 34.0°
 Efficiency 87 %
 Peak intensity 2.6 cd/lm
 LEDs/each optic 1
 Light colour White
 Required components:

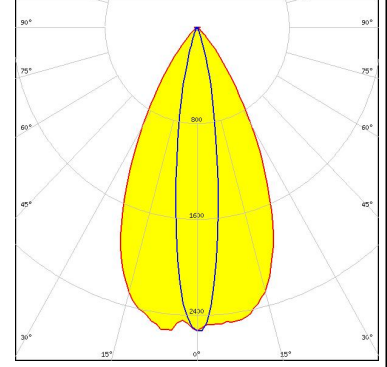

LUMILEDS

LED LUXEON CZ
 FWHM / FWTM 54.0 + 12.0° / 78.0 + 25.0°
 Efficiency 91 %
 Peak intensity 3.5 cd/lm
 LEDs/each optic 1
 Light colour Red
 Required components:

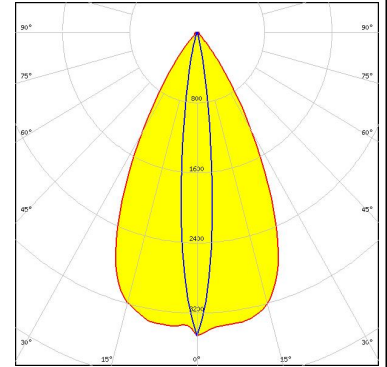

LUMILEDS

LED LUXEON CZ
 FWHM / FWTM 56.0 + 13.0° / 79.0 + 26.0°
 Efficiency 91 %
 Peak intensity 3.3 cd/lm
 LEDs/each optic 1
 Light colour PC Amber
 Required components:

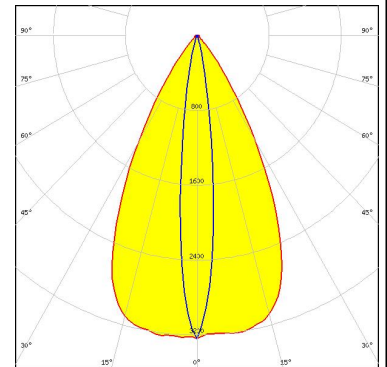

OPTICAL RESULTS (SIMULATED):

LUMILEDS

LED LUXEON HL1Z
 FWHM / FWTM 20.0 + 53.0° / 40.0 + 82.0°
 Efficiency 90 %
 Peak intensity 2 cd/lm
 LEDs/each optic 1
 Light colour White
 Required components:

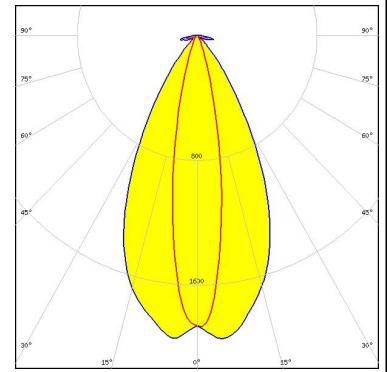

LUMILEDS

LED LUXEON Z ES
 FWHM / FWTM 53.0 + 16.0° / 82.0 + 35.0°
 Efficiency 92 %
 Peak intensity 2.6 cd/lm
 LEDs/each optic 1
 Light colour White
 Required components:

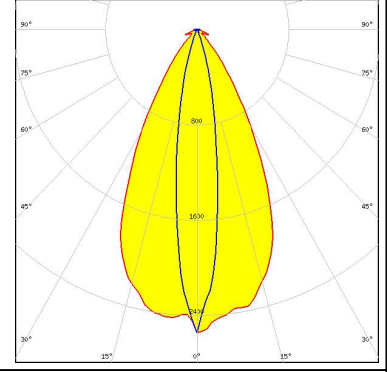

OSRAM

Opto Semiconductors
 LED Duris E 2835
 FWHM / FWTM 18.0 + 52.0° / 48.0 + 82.0°
 Efficiency 88 %
 Peak intensity 2 cd/lm
 LEDs/each optic 1
 Light colour White
 Required components:

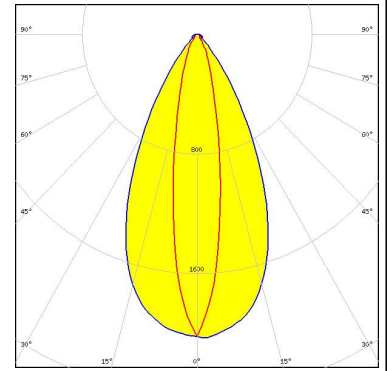

OSRAM

Opto Semiconductors
 LED OSCONIQ P 3737 (2W version)
 FWHM / FWTM 49.0 + 22.0° / 80.0 + 49.0°
 Efficiency 83 %
 Peak intensity 1.9 cd/lm
 LEDs/each optic 1
 Light colour White
 Required components:

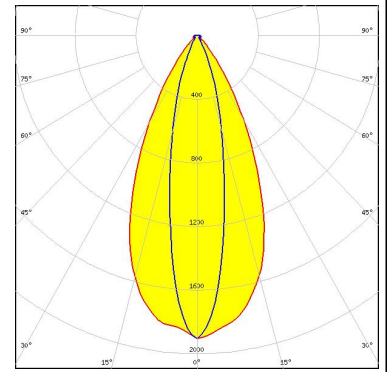

OPTICAL RESULTS (SIMULATED):

OSRAM

Opto Semiconductors

LED OSCONIQ P 3737 (3W version)
 FWHM / FWTM 24.0 + 48.0° / 48.0 + 80.0°
 Efficiency 84 %
 Peak intensity 1.3 cd/lm
 LEDs/each optic 1
 Light colour White
 Required components:

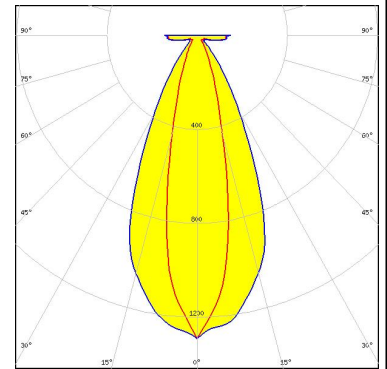

OSRAM

Opto Semiconductors

LED OSLON Square CSSRM2/CSSRM3
 FWHM / FWTM 48.0 + 20.0° / 82.0 + 44.0°
 Efficiency 81 %
 Peak intensity 2 cd/lm
 LEDs/each optic 1
 Light colour White
 Required components:

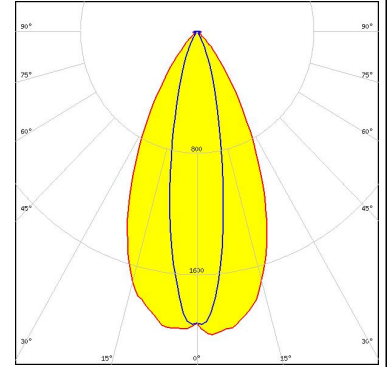

OSRAM

Opto Semiconductors

LED OSLON SSL 150
 FWHM / FWTM 53.0 + 16.0° / 80.0 + 30.0°
 Efficiency 90 %
 Peak intensity 2.8 cd/lm
 LEDs/each optic 1
 Light colour Red
 Required components:

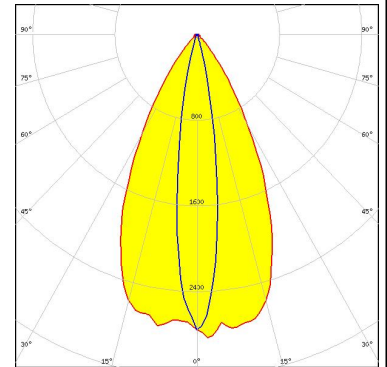

OSRAM

Opto Semiconductors

LED OSLON SSL 150
 FWHM / FWTM 54.0 + 15.0° / 80.0 + 30.0°
 Efficiency 90 %
 Peak intensity 2.8 cd/lm
 LEDs/each optic 1
 Light colour Green
 Required components:

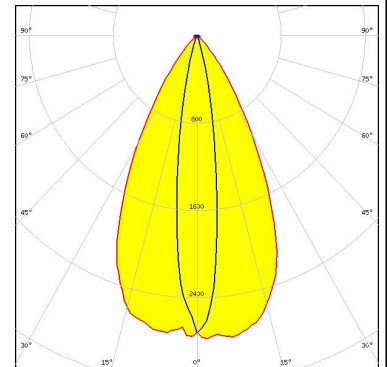

OPTICAL RESULTS (SIMULATED):

OSRAM

Opto Semiconductors

LED OSLOM SSL 150
 FWHM / FWTM 55.0 + 16.0° / 82.0 + 34.0°
 Efficiency 89 %
 Peak intensity 2.6 cd/lm
 LEDs/each optic 1
 Light colour Blue
 Required components:

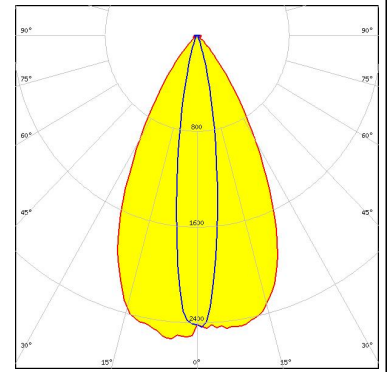

OSRAM

Opto Semiconductors

LED OSLOM SSL 80
 FWHM / FWTM 53.0 + 18.0° / 80.0 + 40.0°
 Efficiency 86 %
 Peak intensity 2.3 cd/lm
 LEDs/each optic 1
 Light colour White
 Required components:

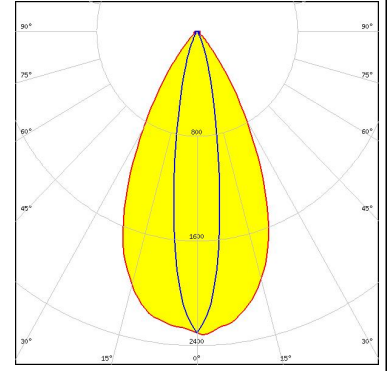

SAMSUNG

LED LH351B
 FWHM / FWTM 49.0 + 24.0° / 83.0 + 53.0°
 Efficiency 84 %
 Peak intensity 1.8 cd/lm
 LEDs/each optic 1
 Light colour White
 Required components:

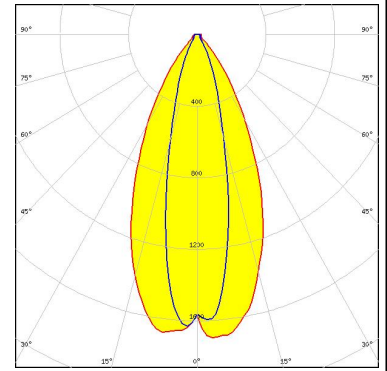



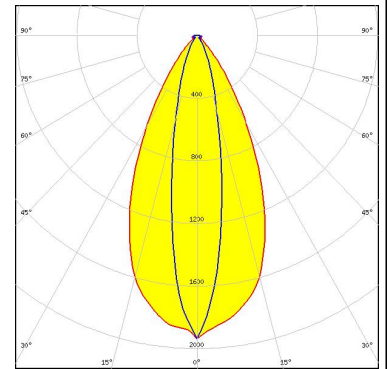

SEOUL SEMICONDUCTOR

LED MJT 3030
 FWHM / FWTM 50.0 + 20.0° / 82.0 + 48.0°
 Efficiency 85 %
 Peak intensity 1.9 cd/lm
 LEDs/each optic 1
 Light colour White
 Required components:

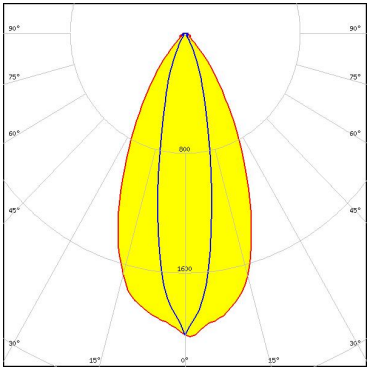

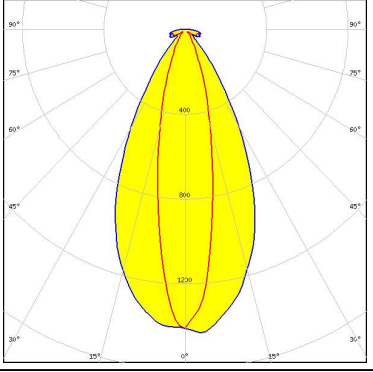
OPTICAL RESULTS (SIMULATED):

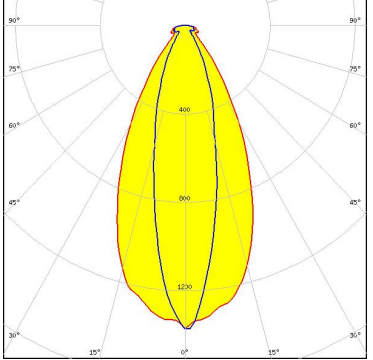
| | |
|--|---|
| <p> SEUL SEMICONDUCTOR</p> <p>LED Z5M1/Z5M2</p> <p>FWHM / FWTM 50.0 + 22.0° / 82.0 + 48.0°</p> <p>Efficiency 88 %</p> <p>Peak intensity 2 cd/lm</p> <p>LEDs/each optic 1</p> <p>Light colour White</p> <p>Required components:</p> |  |
| <p> SEUL SEMICONDUCTOR</p> <p>LED Z8Y19</p> <p>FWHM / FWTM 22.0 + 52.0° / 51.0 + 84.0°</p> <p>Efficiency 87 %</p> <p>Peak intensity 1.4 cd/lm</p> <p>LEDs/each optic 1</p> <p>Light colour White</p> <p>Required components:</p> |  |
| <p> SEUL SEMICONDUCTOR</p> <p>LED Z8Y22T</p> <p>FWHM / FWTM 51.0 + 25.0° / 87.0 + 61.0°</p> <p>Efficiency 87 %</p> <p>Peak intensity 1.4 cd/lm</p> <p>LEDs/each optic 1</p> <p>Light colour White</p> <p>Required components:</p> |  |

GENERAL INFORMATION:

NOTE: The typical beam angle will be changed by different color, chip size and chip position tolerance. The typical total beam angle is the full angle measured where the luminous intensity is half of the peak value.

MATERIALS:

As part of our continuous research and improvement processes, and to ensure the best possible quality and availability of our products, LEDiL reserves the right to change material grades without notice.

PRODUCT DATA USER AGREEMENT AND DISCLAIMER:

The measured data in the provided downloadable LEDiL Product Datasheets and Mechanical 2D-Drawings is rounded and provided as reference for planning. LEDiL Oy's optical specifications have been verified by conducting performance testing of the products in accordance with the company's quality system. The reported data are averaged results of multiple measurements with typical variation. LEDiL Oy reserves the right to without prior notification make changes and improvements to its products.

LEDiL Oy assumes neither warranty, nor guarantee nor any other liability of any kind for the contents and correctness of the provided data. The provided data has been generated with highest diligence but the provided data may in reality not represent the complete possible variation range of all intrinsic parameters. Therefore, in certain cases a deviation from the provided data could occur.

LEDiL Oy reserves the right to undertake technical changes of its products without further notification which could lead to changes in the provided data. LEDiL Oy assumes no liability of any kind for the possible deviation from any provided data or any other damage resulting from the usage of the provided data.

The user agrees to this disclaimer and user agreement with the download or usage of the provided files.

LEDiL Oy

Joensuunkatu 13
FI-24240 SALO
Finland

LEDiL Inc.

228 West Page Street
Suite D
Sycamore IL 60178
USA

Ledil Optics Technology (Shenzhen) Co., Ltd.

405 , Block B
Casic Motor Building
Shenzhen 518057
P.R.CHINA

Local sales and technical support

[www.ledil.com/
where_to_buy](http://www.ledil.com/where_to_buy)

Shipping locations

Salo, Finland
Hong Kong, China

Distribution Partners

[www.ledil.com/
where_to_buy](http://www.ledil.com/where_to_buy)