

## HEIDI-REC-90

~35° + 55° rectangular beam

### SPECIFICATION:

Dimensions	Ø 21.6 mm
Height	12.9 mm
ROHS compliant	yes ⓘ

### MATERIALS:

Component	Type	Material	Colour	Finish
HEIDI-REC-90	Single lens	PMMA	clear	
HEIDI-TAPE	Tape	Acrylic foam	black	



### ORDERING INFORMATION:

Component	Type	Qty in box	MOQ	MPQ	Box weight (kg)
CA14197_HEIDI-REC-90 » Box size: 480 x 280 x 300 mm	Single lens	3264	204	204	10.4

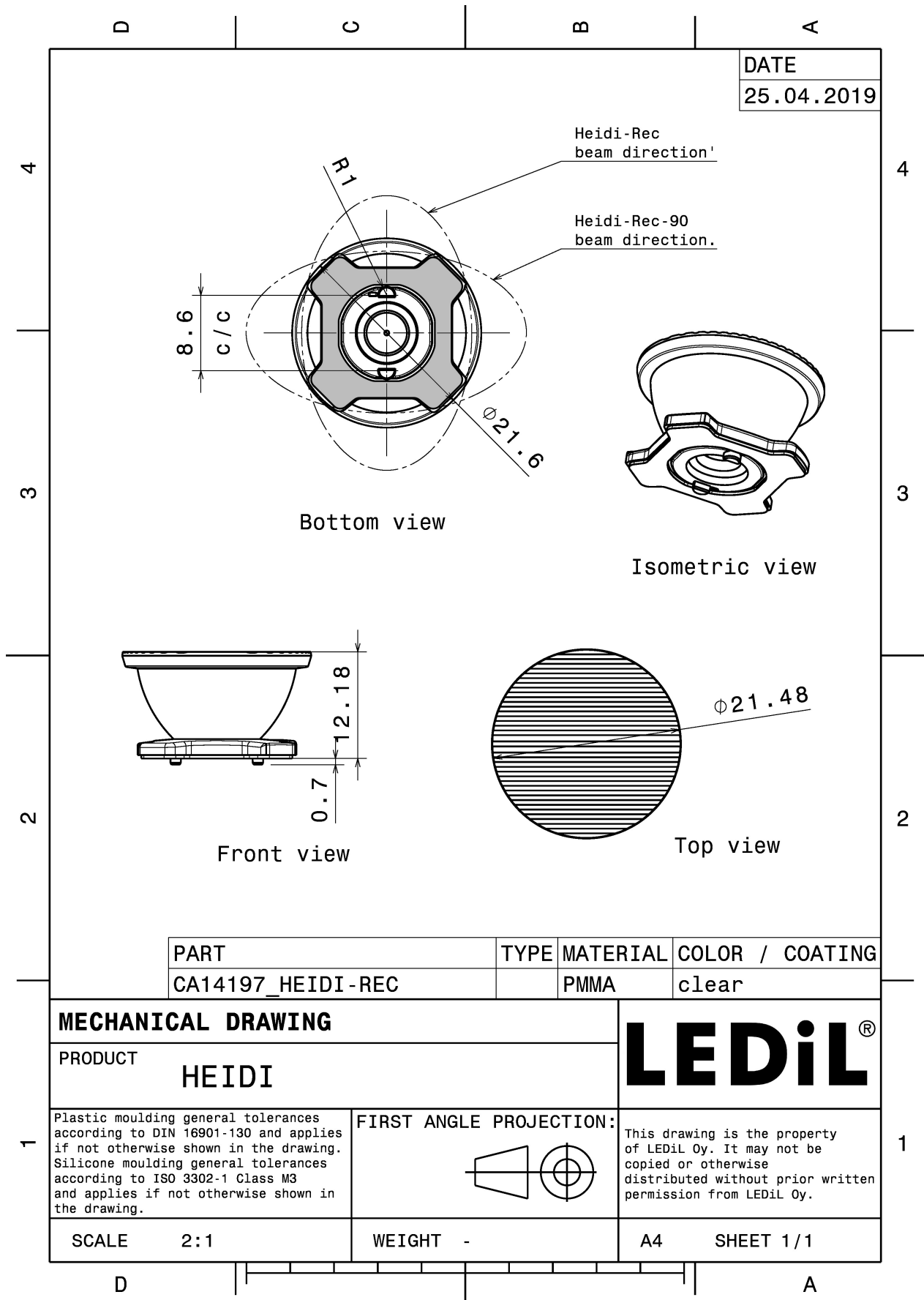

See also our general installation guide: [www.ledil.com/installation\\_guide](http://www.ledil.com/installation_guide)

#### OPTICAL RESULTS (MEASURED):

##### CREE LED

LED XQ-E HD  
 FWHM / FWTM 37.0 + 60.0° / 57.0 + 103.0°  
 Efficiency 88 %  
 Peak intensity 1.3 cd/m  
 LEDs/each optic 1  
 Light colour White  
 Required components:

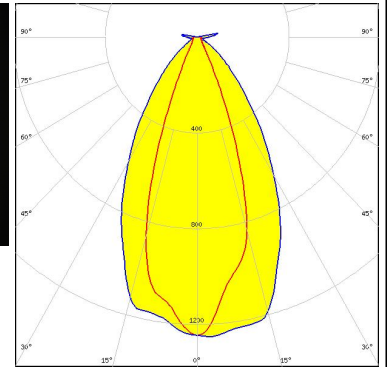
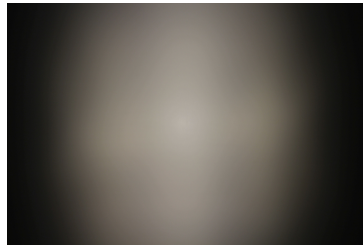

##### CREE LED

LED XQ-E HI  
 FWHM / FWTM 35.0 + 60.0° / 58.0 + 102.0°  
 Efficiency 87 %  
 Peak intensity 1.3 cd/m  
 LEDs/each optic 1  
 Light colour White  
 Required components:

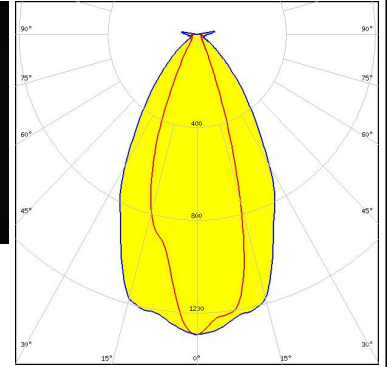

##### LUMILEDS

LED LUXEON Rebel  
 FWHM / FWTM 42.0 + 59.0° / 63.0 + 103.0°  
 Efficiency 78 %  
 Peak intensity 1.1 cd/m  
 LEDs/each optic 1  
 Light colour White  
 Required components:

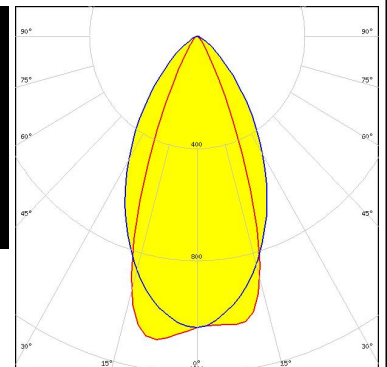
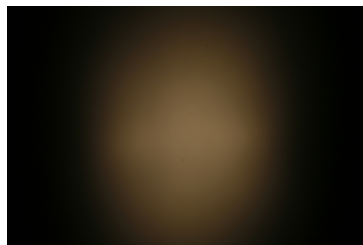

##### OSRAM

Opto Semiconductors  
 LED OSLON SSL 150  
 FWHM / FWTM 36.0 + 57.0° / 57.0 + 100.0°  
 Efficiency 78 %  
 Peak intensity 1.3 cd/m  
 LEDs/each optic 1  
 Light colour White  
 Required components:

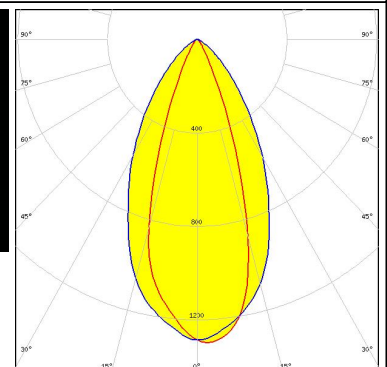
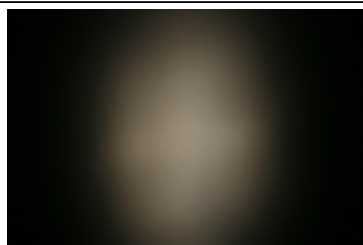

### OPTICAL RESULTS (MEASURED):

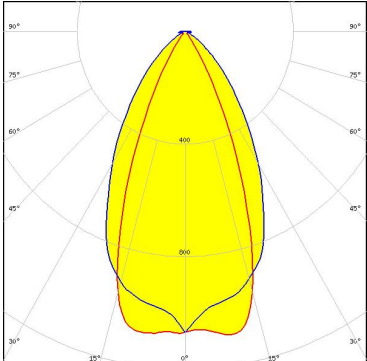
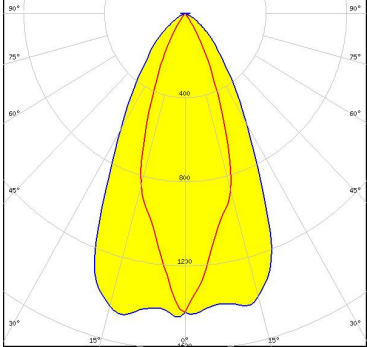
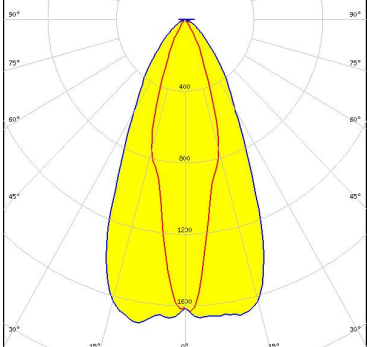
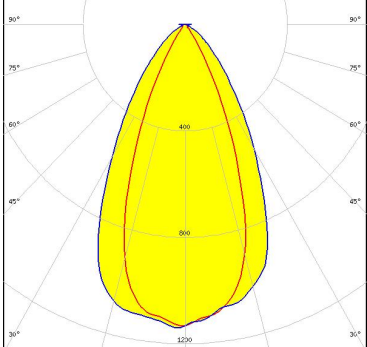

#### OPTICAL RESULTS (SIMULATED):

<p><b>LUMILEDS</b></p> <p>LED LUXEON HL2Z</p> <p>FWHM / FWTM 44.0 + 60.0° / 66.0 + 103.0°</p> <p>Efficiency 87 %</p> <p>Peak intensity 1.1 cd/lm</p> <p>LEDs/each optic 1</p> <p>Light colour White</p> <p>Required components:</p>	
<p><b>LUMILEDS</b></p> <p>LED LUXEON SunPlus 20 Line (120 deg)</p> <p>FWHM / FWTM 35.0 + 56.0° / 61.0 + 100.0°</p> <p>Efficiency 88 %</p> <p>Peak intensity 1.5 cd/lm</p> <p>LEDs/each optic 1</p> <p>Light colour White</p> <p>Required components:</p>	
<p><b>LUMILEDS</b></p> <p>LED LUXEON SunPlus 20 Line (150 deg)</p> <p>FWHM / FWTM 26.0 + 50.0° / 56.0 + 94.0°</p> <p>Efficiency 83 %</p> <p>Peak intensity 1.7 cd/lm</p> <p>LEDs/each optic 1</p> <p>Light colour White</p> <p>Required components:</p>	
<p><b>LUMILEDS</b></p> <p>LED LUXEON TX</p> <p>FWHM / FWTM 42.0 + 59.0° / 65.0 + 101.0°</p> <p>Efficiency 89 %</p> <p>Peak intensity 1.1 cd/lm</p> <p>LEDs/each optic 1</p> <p>Light colour White</p> <p>Required components:</p>	

#### OPTICAL RESULTS (SIMULATED):

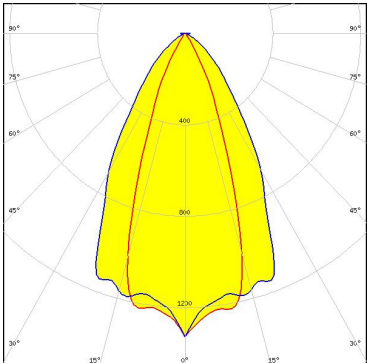
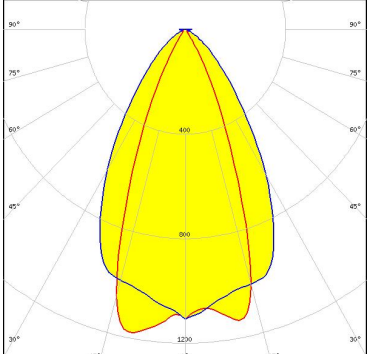
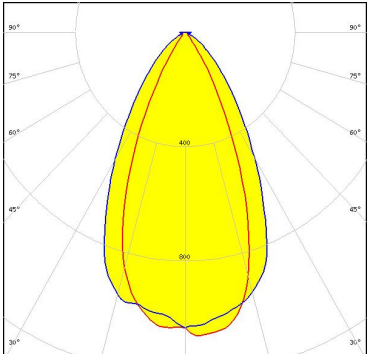
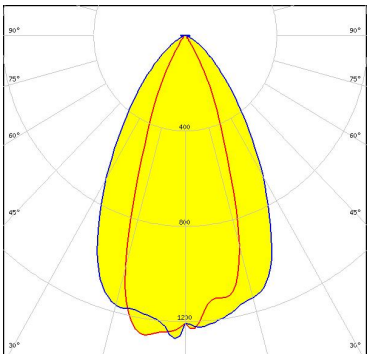
<p><b>LUMILEDS</b></p> <p>LED LUXEON Z ES</p> <p>FWHM / FWTM 37.0 + 62.0° / 60.0 + 102.0°</p> <p>Efficiency 89 %</p> <p>Peak intensity 1.3 cd/lm</p> <p>LEDs/each optic 1</p> <p>Light colour White</p> <p>Required components:</p>	
<p><b>NICHIA</b></p> <p>LED NCSxx19A</p> <p>FWHM / FWTM 41.0 + 64.0° / 61.0 + 104.0°</p> <p>Efficiency 89 %</p> <p>Peak intensity 1.2 cd/lm</p> <p>LEDs/each optic 1</p> <p>Light colour White</p> <p>Required components:</p>	
<p><b>NICHIA</b></p> <p>LED NVSxx19B/NVSxx19C</p> <p>FWHM / FWTM 45.0 + 60.0° / 68.0 + 102.0°</p> <p>Efficiency 88 %</p> <p>Peak intensity 1.1 cd/lm</p> <p>LEDs/each optic 1</p> <p>Light colour White</p> <p>Required components:</p>	
<p><b>OSRAM</b> Opto Semiconductors</p> <p>LED OSCONIQ P 3030</p> <p>FWHM / FWTM 38.0 + 62.0° / 61.0 + 104.0°</p> <p>Efficiency 89 %</p> <p>Peak intensity 1.3 cd/lm</p> <p>LEDs/each optic 1</p> <p>Light colour White</p> <p>Required components:</p>	

#### OPTICAL RESULTS (SIMULATED):

**OSRAM**  
Opto Semiconductors

LED	OSLON Square CSSRM2/CSSRM3
FWHM / FWTM	43.0 + 58.0° / 65.0 + 100.0°
Efficiency	89 %
Peak intensity	1.1 cd/lm
LEDs/each optic	1
Light colour	White
Required components:	

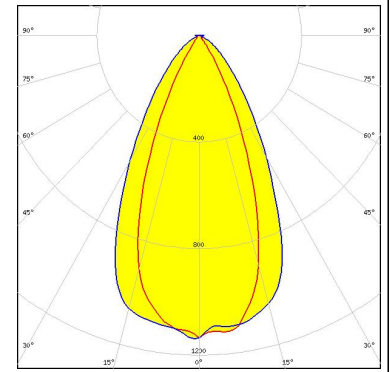

### GENERAL INFORMATION:

NOTE: The typical beam angle will be changed by different color, chip size and chip position tolerance. The typical total beam angle is the full angle measured where the luminous intensity is half of the peak value.

### MATERIALS:

As part of our continuous research and improvement processes, and to ensure the best possible quality and availability of our products, LEDiL reserves the right to change material grades without notice.

### PRODUCT DATA USER AGREEMENT AND DISCLAIMER:

The measured data in the provided downloadable LEDiL Product Datasheets and Mechanical 2D-Drawings is rounded and provided as reference for planning. LEDiL Oy's optical specifications have been verified by conducting performance testing of the products in accordance with the company's quality system. The reported data are averaged results of multiple measurements with typical variation. LEDiL Oy reserves the right to without prior notification make changes and improvements to its products.

LEDiL Oy assumes neither warranty, nor guarantee nor any other liability of any kind for the contents and correctness of the provided data. The provided data has been generated with highest diligence but the provided data may in reality not represent the complete possible variation range of all intrinsic parameters. Therefore, in certain cases a deviation from the provided data could occur.

LEDiL Oy reserves the right to undertake technical changes of its products without further notification which could lead to changes in the provided data. LEDiL Oy assumes no liability of any kind for the possible deviation from any provided data or any other damage resulting from the usage of the provided data.

The user agrees to this disclaimer and user agreement with the download or usage of the provided files.

#### LEDiL Oy

Joensuunkatu 13  
FI-24240 SALO  
Finland

#### LEDiL Inc.

228 West Page Street  
Suite D  
Sycamore IL 60178  
USA

#### Ledil Optics Technology (Shenzhen) Co., Ltd.

# 405 , Block B  
Casic Motor Building  
Shenzhen 518057  
P.R.CHINA

#### Local sales and technical support

[www.ledil.com/  
where\\_to\\_buy](http://www.ledil.com/where_to_buy)

#### Shipping locations

Salo, Finland  
Hong Kong, China

#### Distribution Partners

[www.ledil.com/  
where\\_to\\_buy](http://www.ledil.com/where_to_buy)