

VERONICA-SQ-O

~55° + 12° oval beam

SPECIFICATION:

Dimensions	Ø 22.5 mm
Height	12.2 mm
Fastening	tape, pin
ROHS compliant	yes ⓘ

MATERIALS:

Component	Type	Material	Colour	Finish
VERONICA-SQ-O	Single lens	PMMA	clear	
VERONICA-TAPE	Tape	Acrylic foam	clear	

ORDERING INFORMATION:



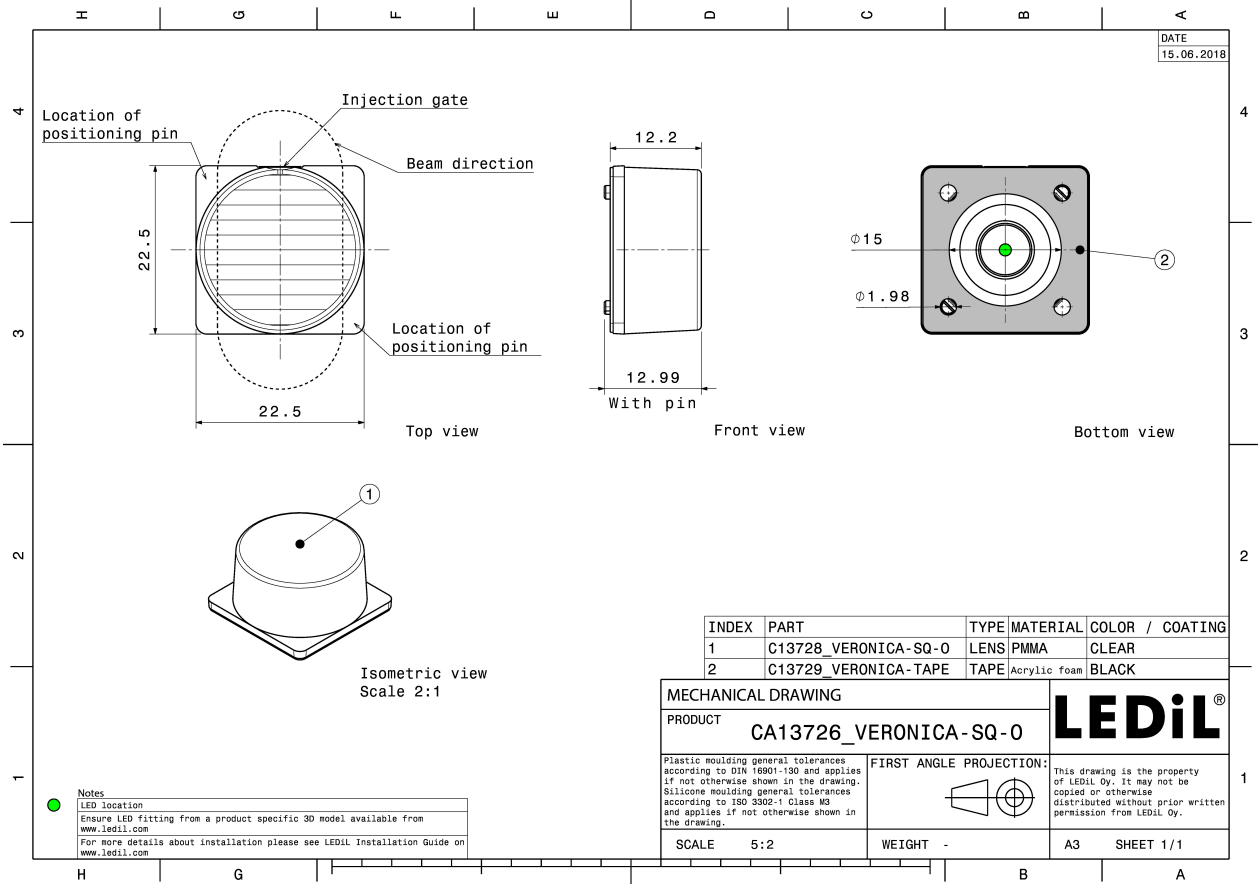

Component	Type	Qty in box	MOQ	MPQ	Box weight (kg)
CA13726_VERONICA-SQ-O » Box size: 480 x 280 x 300 mm	Single lens	1980	360	90	8.2



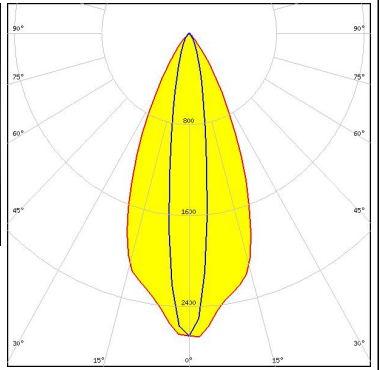

See also our general installation guide: www.ledil.com/installation_guide

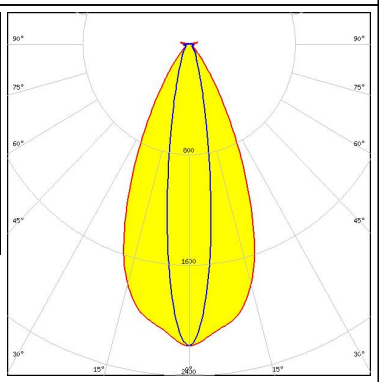
OPTICAL RESULTS (MEASURED):

<p>CREE → LED</p> <p>LED XB-H FWHM / FWTM 45.0 + 16.0° / 73.0 + 40.0° Efficiency 77 % Peak intensity 2.7 cd/lm LEDs/each optic 1 Light colour White Required components:</p>		
<p>CREE → LED</p> <p>LED XD16 FWHM / FWTM 47.0 + 17.0° / 76.0 + 41.0° Efficiency 87 % Peak intensity 2.2 cd/lm LEDs/each optic 1 Light colour White Required components:</p>		
<p>CREE → LED</p> <p>LED XHP35 HD FWHM / FWTM 45.0 + 20.0° / 78.0 + 48.0° Efficiency 73 % Peak intensity 2.1 cd/lm LEDs/each optic 1 Light colour White Required components:</p>		
<p>CREE → LED</p> <p>LED XHP35 HI FWHM / FWTM 46.0 + 16.0° / 74.0 + 40.0° Efficiency 75 % Peak intensity 2.7 cd/lm LEDs/each optic 1 Light colour White Required components:</p>		

OPTICAL RESULTS (MEASURED):

CREE LED

LED XM-L
 FWHM / FWTM 47.0 + 20.0° / 77.0 + 46.0°
 Efficiency 80 %
 Peak intensity 2.3 cd/lm
 LEDs/each optic 1
 Light colour White
 Required components:

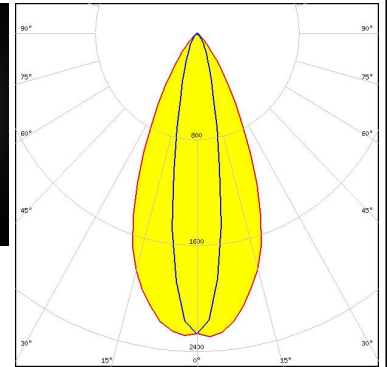

CREE LED

LED XM-L2
 FWHM / FWTM 47.0 + 20.0° / 76.0 + 45.0°
 Efficiency 80 %
 Peak intensity 2.3 cd/lm
 LEDs/each optic 1
 Light colour White
 Required components:

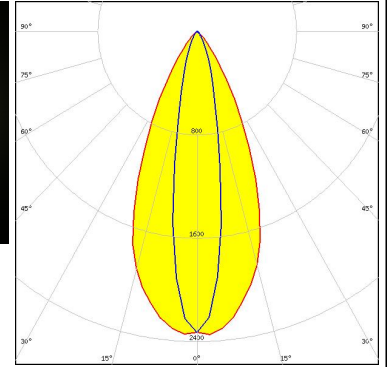

CREE LED

LED XM-L3
 FWHM / FWTM 47.0 + 19.0° / 77.0 + 46.0°
 Efficiency 88 %
 Peak intensity 2.2 cd/lm
 LEDs/each optic 1
 Light colour White
 Required components:

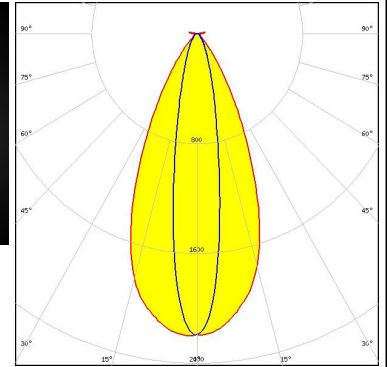

CREE LED

LED XP-E2
 FWHM / FWTM 46.0 + 12.0° / 71.0 + 34.0°
 Efficiency 80 %
 Peak intensity 3.5 cd/lm
 LEDs/each optic 1
 Light colour White
 Required components:

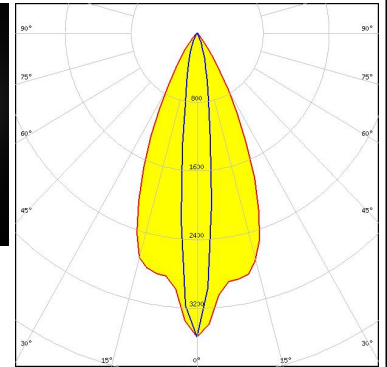

OPTICAL RESULTS (MEASURED):

CREE LED

LED XP-G2
 FWHM / FWTM 47.0 + 14.0° / 76.0 + 40.0°
 Efficiency 80 %
 Peak intensity 2.9 cd/m
 LEDs/each optic 1
 Light colour White
 Required components:

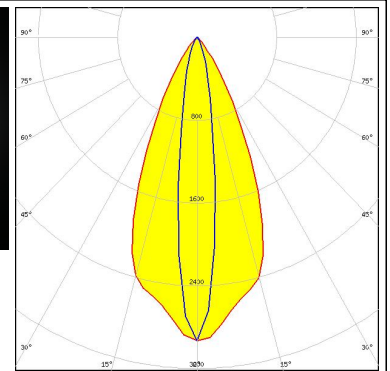

CREE LED

LED XP-L2
 FWHM / FWTM 45.0 + 20.0° / 78.0 + 49.0°
 Efficiency 86 %
 Peak intensity 1.9 cd/m
 LEDs/each optic 1
 Light colour White
 Required components:

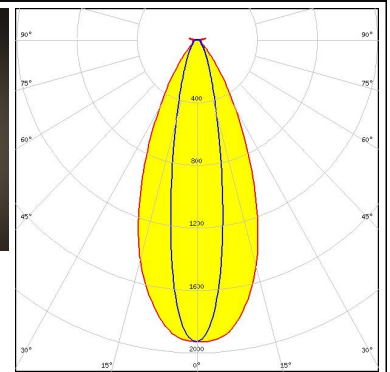
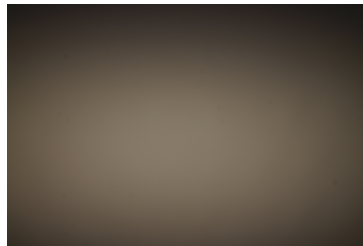

CREE LED

LED XT-E
 FWHM / FWTM 47.0 + 16.0° / 74.0 + 40.0°
 Efficiency 79 %
 Peak intensity 2.8 cd/m
 LEDs/each optic 1
 Light colour White
 Required components:

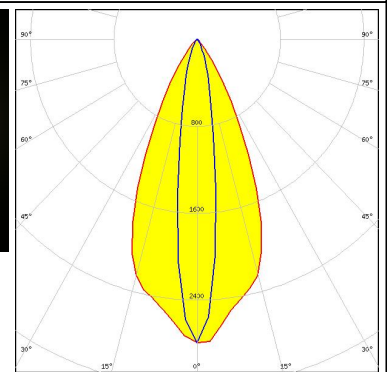

LUMILEDS

LED LUXEON M/MX
 FWHM / FWTM 45.0 + 28.0° / 81.0 + 60.0°
 Efficiency 76 %
 Peak intensity 1.6 cd/m
 LEDs/each optic 1
 Light colour White
 Required components:

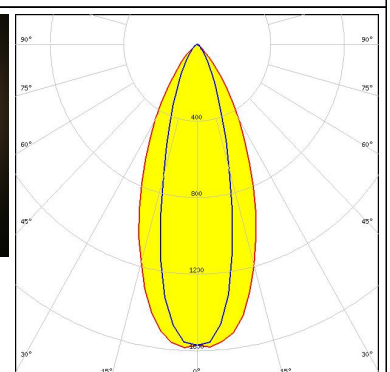
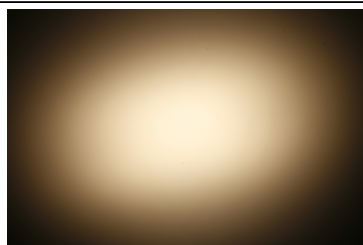

OPTICAL RESULTS (MEASURED):

LUMILEDS

LED LUXEON MZ
 FWHM / FWTM 47.0 + 23.0° / 77.0 + 46.0°
 Efficiency 73 %
 Peak intensity 2 cd/lm
 LEDs/each optic 1
 Light colour White
 Required components:

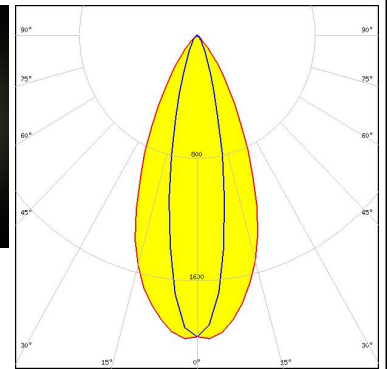

LUMILEDS

LED LUXEON Rebel
 FWHM / FWTM 47.0 + 15.0° / 72.0 + 38.0°
 Efficiency 80 %
 Peak intensity 3 cd/lm
 LEDs/each optic 1
 Light colour White
 Required components:

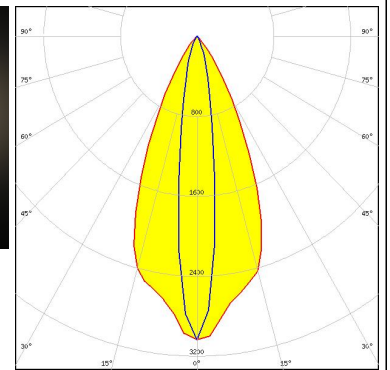

LUMILEDS

LED LUXEON Rebel ES
 FWHM / FWTM 47.0 + 17.0° / 74.0 + 39.0°
 Efficiency 80 %
 Peak intensity 2.7 cd/lm
 LEDs/each optic 1
 Light colour White
 Required components:

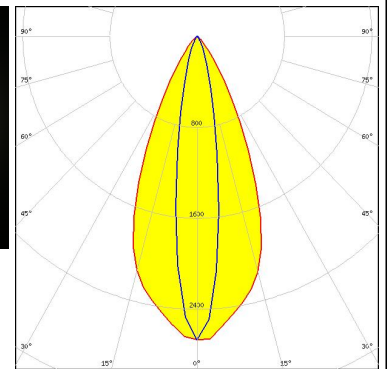

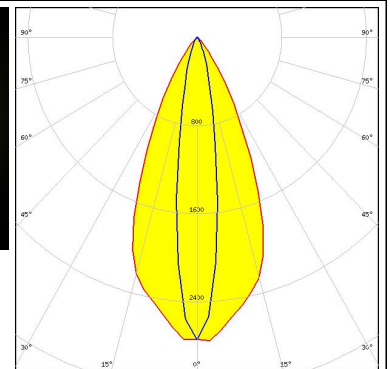
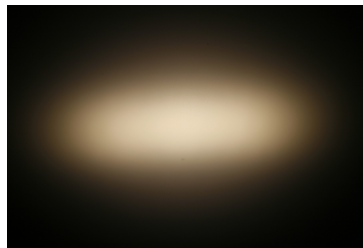

LUMILEDS

LED LUXEON T
 FWHM / FWTM 47.0 + 17.0° / 74.0 + 39.0°
 Efficiency 80 %
 Peak intensity 2.8 cd/lm
 LEDs/each optic 1
 Light colour White
 Required components:

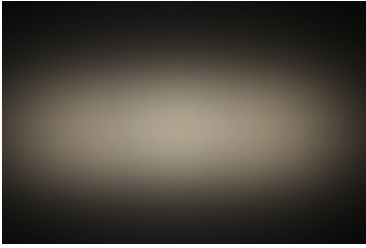
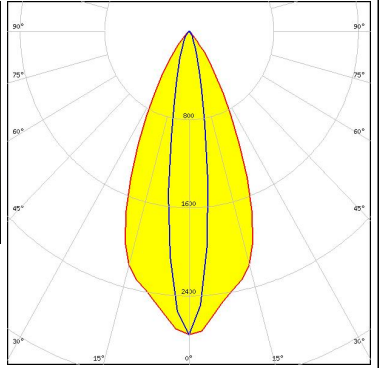
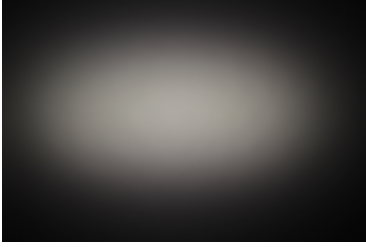
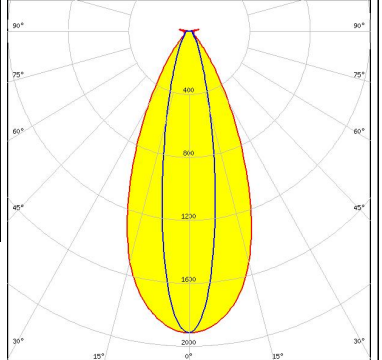

OPTICAL RESULTS (MEASURED):

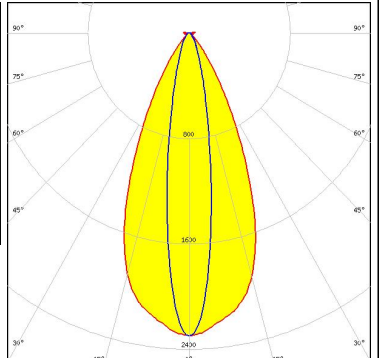
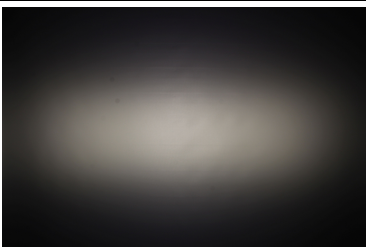
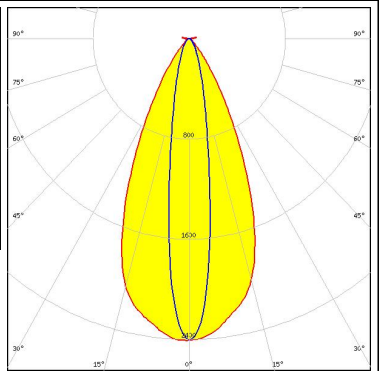
<p>LUMILEDS</p> <p>LED LUXEON TX</p> <p>FWHM / FWTM 46.0 + 16.0° / 73.0 + 37.0°</p> <p>Efficiency 77 %</p> <p>Peak intensity 2.8 cd/m</p> <p>LEDs/each optic 1</p> <p>Light colour White</p> <p>Required components:</p>		
<p>LUMILEDS</p> <p>LED LUXEON V</p> <p>FWHM / FWTM 46.0 + 21.0° / 79.0 + 50.0°</p> <p>Efficiency 88 %</p> <p>Peak intensity 1.9 cd/m</p> <p>LEDs/each optic 1</p> <p>Light colour White</p> <p>Required components:</p>		
<p>LUMILEDS</p> <p>LED LUXEON V2</p> <p>FWHM / FWTM 47.0 + 17.0° / 76.0 + 43.0°</p> <p>Efficiency 87 %</p> <p>Peak intensity 2.3 cd/m</p> <p>LEDs/each optic 1</p> <p>Light colour White</p> <p>Required components:</p>		
<p>NICHIA</p> <p>LED NVSW219F</p> <p>FWHM / FWTM 48.0 + 16.0° / 76.0 + 42.0°</p> <p>Efficiency 88 %</p> <p>Peak intensity 2.4 cd/m</p> <p>LEDs/each optic 1</p> <p>Light colour White</p> <p>Required components:</p>		

OPTICAL RESULTS (MEASURED):



LED NVSxx19B/NVSxx19C
 FWHM / FWTM 47.0 + 18.0° / 74.0 + 37.0°
 Efficiency 80 %
 Peak intensity 2.6 cd/lm
 LEDs/each optic 1
 Light colour White
 Required components:

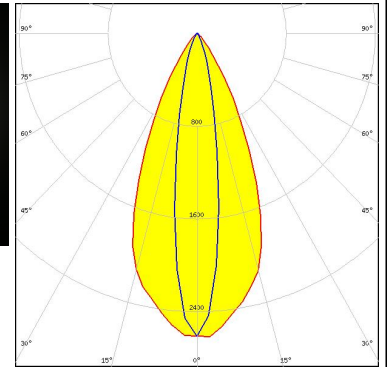

LED NWSx229A
 FWHM / FWTM 20.0 + 45.0° / 75.0 + 45.0°
 Efficiency 74 %
 Peak intensity 2 cd/lm
 LEDs/each optic 1
 Light colour White
 Required components:

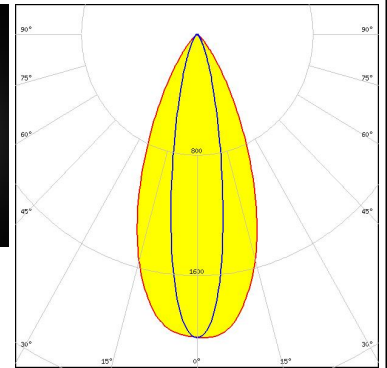

LED OSLOM Square EC
 FWHM / FWTM 47.0 + 17.0° / 74.0 + 39.0°
 Efficiency 79 %
 Peak intensity 2.8 cd/lm
 LEDs/each optic 1
 Light colour White
 Required components:

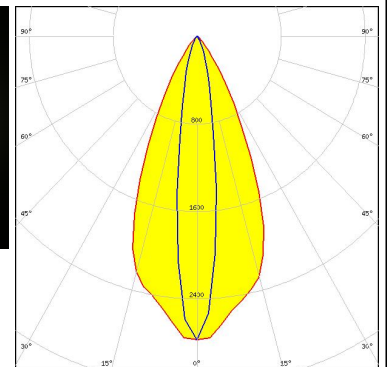

LED LH181A
 FWHM / FWTM 46.0 + 22.0° / 79.0 + 48.0°
 Efficiency 85 %
 Peak intensity 1.7 cd/lm
 LEDs/each optic 1
 Light colour White
 Required components:

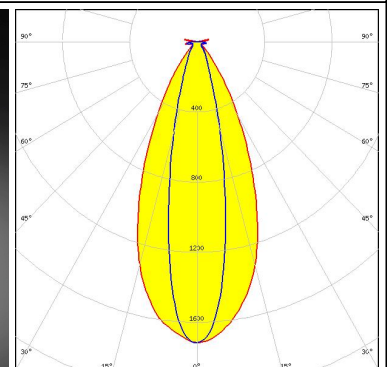
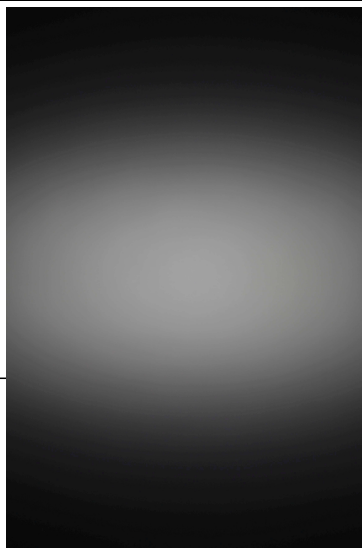

OPTICAL RESULTS (MEASURED):

SAMSUNG

LED LH181B
 FWHM / FWTM 46.0 + 21.0° / 78.0 + 44.0°
 Efficiency 88 %
 Peak intensity 2 cd/lm
 LEDs/each optic 1
 Light colour White
 Required components:

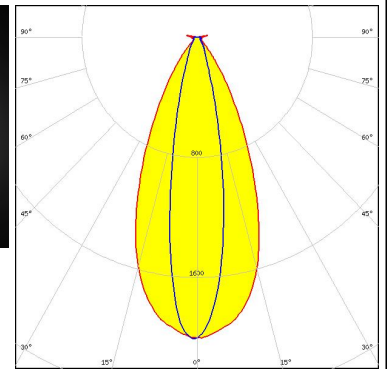

SAMSUNG

LED LH351Z
 FWHM / FWTM 47.0 + 15.0° / 73.0 + 40.0°
 Efficiency 78 %
 Peak intensity 2.8 cd/lm
 LEDs/each optic 1
 Light colour White
 Required components:

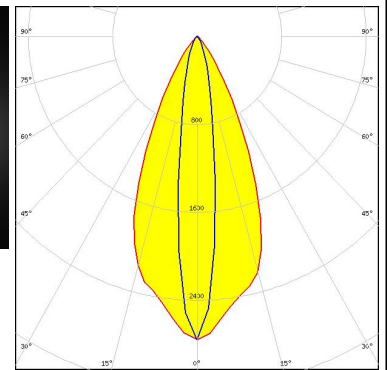
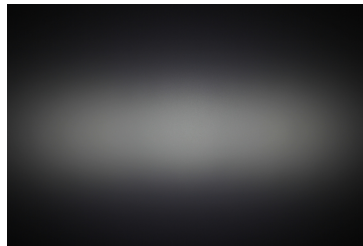

SEOUL SEMICONDUCTOR

LED MJT 5050
 FWHM / FWTM 45.0 + 28.0° / 82.0 + 60.0°
 Efficiency 87 %
 Peak intensity 1.6 cd/lm
 LEDs/each optic 1
 Light colour White
 Required components:

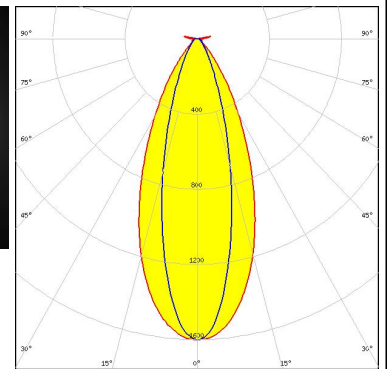
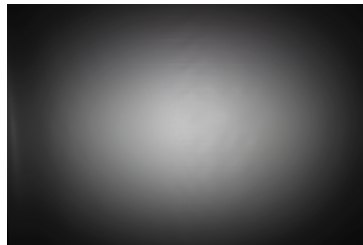



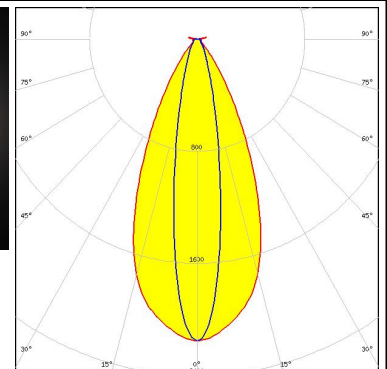
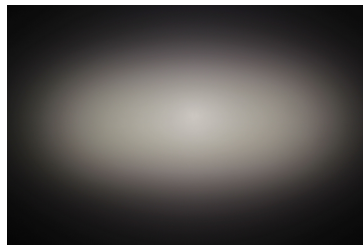

SEOUL SEMICONDUCTOR

LED Z5M3
 FWHM / FWTM 47.0 + 18.0° / 77.0 + 45.0°
 Efficiency 89 %
 Peak intensity 2.2 cd/lm
 LEDs/each optic 1
 Light colour White
 Required components:

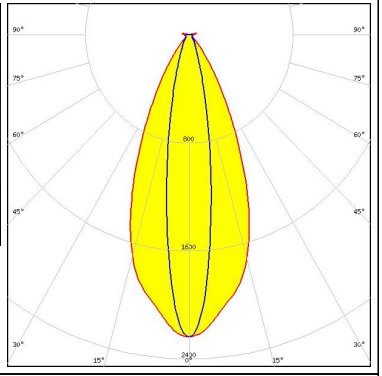

OPTICAL RESULTS (MEASURED):

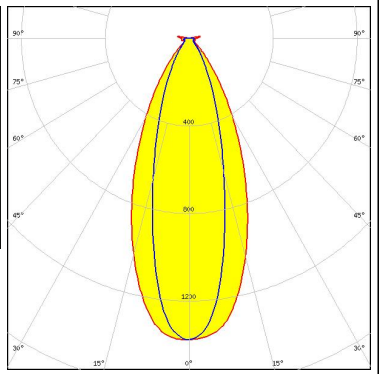
<p> SEOUL SEMICONDUCTOR</p> <p>LED Z8Y22P</p> <p>FWHM / FWTM 45.0 + 18.0° / 75.0 + 42.0°</p> <p>Efficiency 86 %</p> <p>Peak intensity 2.2 cd/lm</p> <p>LEDs/each optic 1</p> <p>Light colour White</p> <p>Required components:</p>		
<p> SEOUL SEMICONDUCTOR</p> <p>LED Z8Y50P</p> <p>FWHM / FWTM 45.0 + 29.0° / 83.0 + 65.0°</p> <p>Efficiency 81 %</p> <p>Peak intensity 1.4 cd/lm</p> <p>LEDs/each optic 1</p> <p>Light colour White</p> <p>Required components:</p>		

OPTICAL RESULTS (SIMULATED):

CREE LED

LED XP-G2 HE
 FWHM / FWTM 54.0 + 14.0° / 80.0 + 35.0°
 Efficiency 92 %
 Peak intensity 2.8 cd/lm
 LEDs/each optic 1
 Light colour White
 Required components:

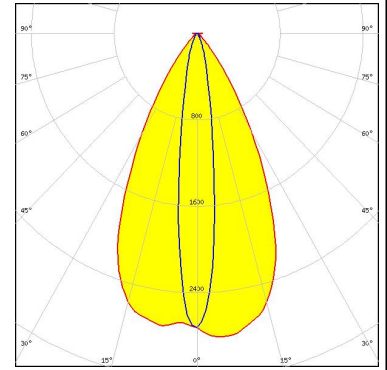

CREE LED

LED XP-L HD
 FWHM / FWTM 53.0 + 16.0° / 82.0 + 38.0°
 Efficiency 86 %
 Peak intensity 2.5 cd/lm
 LEDs/each optic 1
 Light colour White
 Required components:

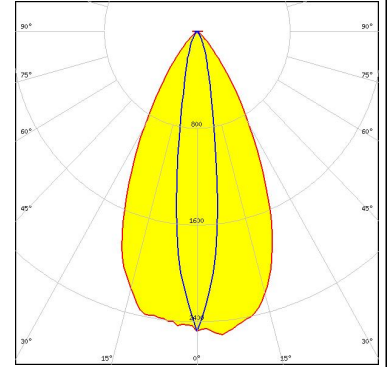

LUMILEDS

LED LUXEON C
 FWHM / FWTM 46.0 + 27.0° / 85.0 + 53.0°
 Efficiency 84 %
 Peak intensity 1.7 cd/lm
 LEDs/each optic 4
 Light colour RGBW
 Required components:

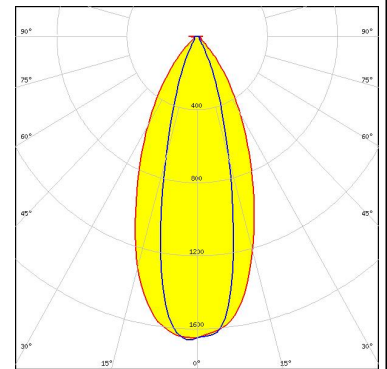

LUMINUS

LED SFT-40-WCS
 FWHM / FWTM 54.0 + 10.0° / 78.0 + 26.0°
 Efficiency 92 %
 Peak intensity 3.7 cd/lm
 LEDs/each optic 1
 Light colour White
 Required components:

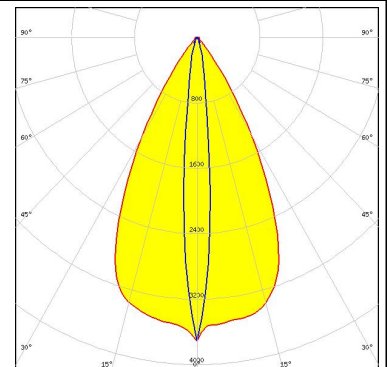

OPTICAL RESULTS (SIMULATED):

<p>LUMINUS</p> <p>LED SFT-70X-WCS</p> <p>FWHM / FWTM 54.0 + 14.0° / 80.0 + 31.0°</p> <p>Efficiency 92 %</p> <p>Peak intensity 3 cd/lm</p> <p>LEDs/each optic 1</p> <p>Light colour White</p> <p>Required components:</p>	
<p>NICHIA</p> <p>LED NCSxE17A</p> <p>FWHM / FWTM 50.0 + 24.0° / 84.0 + 48.0°</p> <p>Efficiency 83 %</p> <p>Peak intensity 1.8 cd/lm</p> <p>LEDs/each optic 4</p> <p>Light colour White</p> <p>Required components:</p>	
<p>NICHIA</p> <p>LED NV4WB35AM</p> <p>FWHM / FWTM 50.0 + 18.0° / 82.0 + 40.0°</p> <p>Efficiency 88 %</p> <p>Peak intensity 2.5 cd/lm</p> <p>LEDs/each optic 1</p> <p>Light colour White</p> <p>Required components:</p>	
<p>OSRAM Opto Semiconductors</p> <p>LED OSCONIQ P 3030</p> <p>FWHM / FWTM 56.0 + 12.0° / 79.0 + 26.0°</p> <p>Efficiency 88 %</p> <p>Peak intensity 3.4 cd/lm</p> <p>LEDs/each optic 1</p> <p>Light colour White</p> <p>Required components:</p>	

OPTICAL RESULTS (SIMULATED):

<p>OSRAM Opto Semiconductors</p> <p>LED OSCONIQ P 7070</p> <p>FWHM / FWTM 49.0 + 25.0° / 83.0 + 53.0°</p> <p>Efficiency 84 %</p> <p>Peak intensity 1.8 cd/lm</p> <p>LEDs/each optic 1</p> <p>Light colour White</p> <p>Required components:</p>	
<p>OSRAM Opto Semiconductors</p> <p>LED OSLOM Square CSSRM2/CSSRM3</p> <p>FWHM / FWTM 56.0 + 12.0° / 58.0 + 28.0°</p> <p>Efficiency 88 %</p> <p>Peak intensity 3.5 cd/lm</p> <p>LEDs/each optic 1</p> <p>Light colour White</p> <p>Required components:</p>	
<p>SEOUL SEMICONDUCTOR</p> <p>LED Z8Y22T</p> <p>FWHM / FWTM 54.0 + 16.0° / 82.0 + 35.0°</p> <p>Efficiency 89 %</p> <p>Peak intensity 2.6 cd/lm</p> <p>LEDs/each optic 1</p> <p>Light colour White</p> <p>Required components:</p>	

GENERAL INFORMATION:

NOTE: The typical beam angle will be changed by different color, chip size and chip position tolerance. The typical total beam angle is the full angle measured where the luminous intensity is half of the peak value.

MATERIALS:

As part of our continuous research and improvement processes, and to ensure the best possible quality and availability of our products, LEDiL reserves the right to change material grades without notice.

PRODUCT DATA USER AGREEMENT AND DISCLAIMER:

The measured data in the provided downloadable LEDiL Product Datasheets and Mechanical 2D-Drawings is rounded and provided as reference for planning. LEDiL Oy's optical specifications have been verified by conducting performance testing of the products in accordance with the company's quality system. The reported data are averaged results of multiple measurements with typical variation. LEDiL Oy reserves the right to without prior notification make changes and improvements to its products.

LEDiL Oy assumes neither warranty, nor guarantee nor any other liability of any kind for the contents and correctness of the provided data. The provided data has been generated with highest diligence but the provided data may in reality not represent the complete possible variation range of all intrinsic parameters. Therefore, in certain cases a deviation from the provided data could occur.

LEDiL Oy reserves the right to undertake technical changes of its products without further notification which could lead to changes in the provided data. LEDiL Oy assumes no liability of any kind for the possible deviation from any provided data or any other damage resulting from the usage of the provided data.

The user agrees to this disclaimer and user agreement with the download or usage of the provided files.

LEDiL Oy

Joensuunkatu 13
FI-24240 SALO
Finland

LEDiL Inc.

228 West Page Street
Suite D
Sycamore IL 60178
USA

Ledil Optics Technology (Shenzhen) Co., Ltd.

405 , Block B
Casic Motor Building
Shenzhen 518057
P.R.CHINA

Local sales and technical support

[www.ledil.com/
where_to_buy](http://www.ledil.com/where_to_buy)

Shipping locations

Salo, Finland
Hong Kong, China

Distribution Partners

[www.ledil.com/
where_to_buy](http://www.ledil.com/where_to_buy)