

BARBARA-S-PF

~15° spot beam

SPECIFICATION:

Dimensions	Ø 70.0 mm
Height	41.7 mm
Fastening	socket
ROHS compliant	yes ⓘ

MATERIALS:

Component	Type	Material	Colour	Finish	Coating
BARBARA-S-PF	Reflector	PC	metal		HMDS







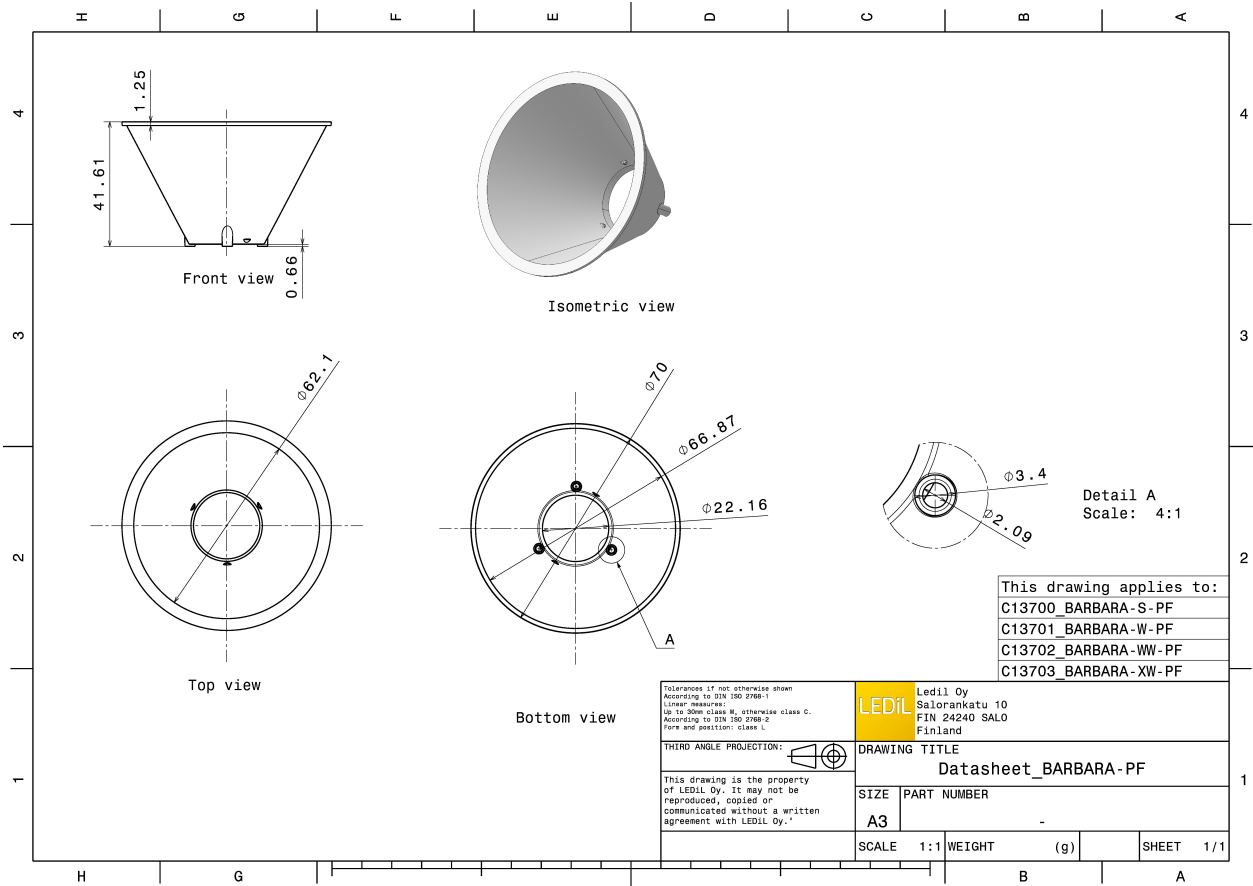



ORDERING INFORMATION:

Component	Qty in box	MOQ	MPQ	Box weight (kg)
F13700_BARBARA-S-PF » Box size: 480 x 280 x 300 mm	288	90	18	6.1

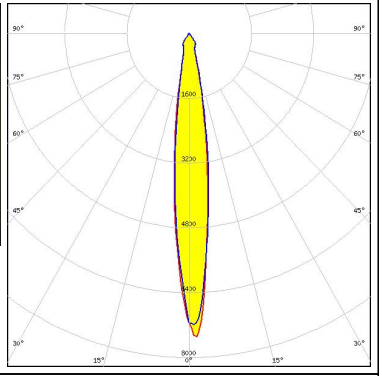

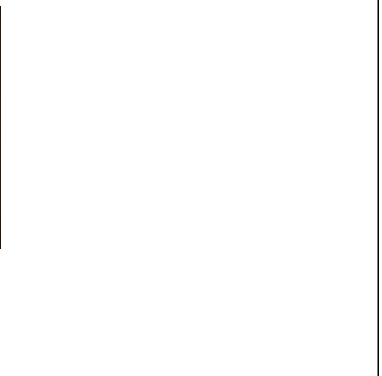

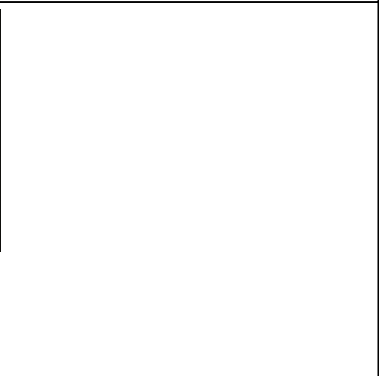

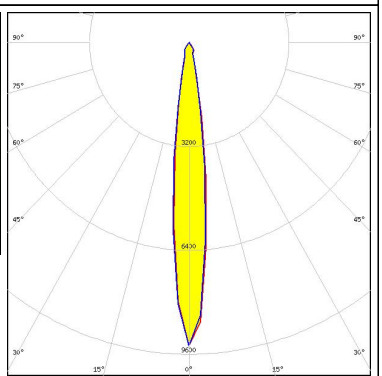

See also our general installation guide: www.ledil.com/installation_guide

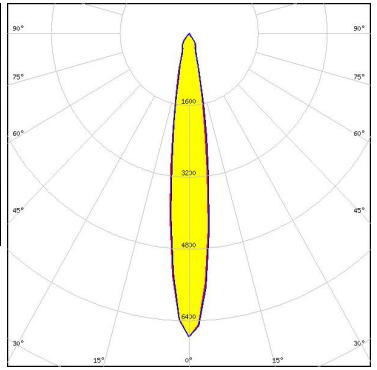
OPTICAL RESULTS (MEASURED):

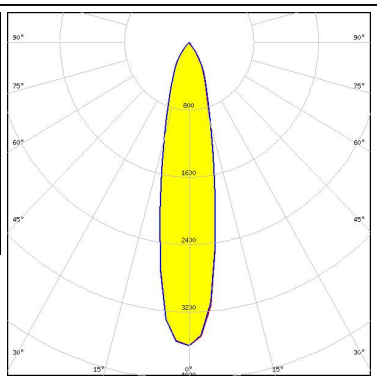
<p></p> <p>LED V10 Gen7 FWHM / FWTM 14.0° / 30.0° Efficiency 88 % Peak intensity 7.5 cd/lm LEDs/each optic 1 Light colour White</p> <p>Required components: C13709_PF-SOCKET-VERO13-18 Bender Wirth: 434 Typ L1</p>		
<p></p> <p>LED V15 Gen6 FWHM / FWTM 18.0° / 52.0° Efficiency 92 % Peak intensity 4.8 cd/lm LEDs/each optic 1 Light colour White</p> <p>Required components: C13709_PF-SOCKET-VERO13-18 Bender Wirth: 456 Typ L2</p>		
<p></p> <p>LED V8 Gen6 FWHM / FWTM 13.0° / 28.0° Efficiency 86 % Peak intensity 10.6 cd/lm LEDs/each optic 1 Light colour White</p> <p>Required components: C13709_PF-SOCKET-VERO13-18 Bender Wirth: 460 Typ L1</p>		
<p></p> <p>LED VERO10 FWHM / FWTM 13.0° / 27.0° Efficiency 90 % Peak intensity 9.3 cd/lm LEDs/each optic 1 Light colour White</p> <p>Required components: C13708_PF-SOCKET-VERO10</p>		

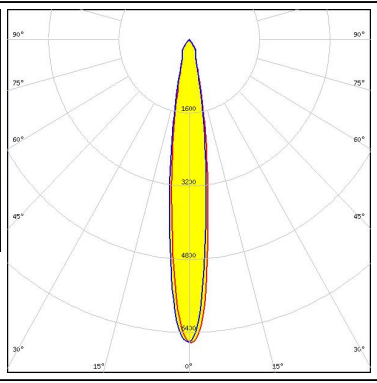
OPTICAL RESULTS (MEASURED):

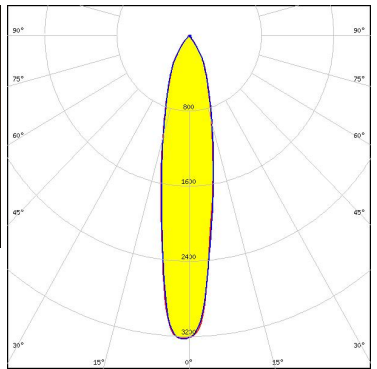
<p>bridgelux.</p> <p>LED VERO13</p> <p>FWHM / FWTM 15.0° / 35.0°</p> <p>Efficiency 91 %</p> <p>Peak intensity 6.8 cd/m</p> <p>LEDs/each optic 1</p> <p>Light colour White</p> <p>Required components: C13709_PF-SOCKET-VERO13-18</p>		
<p>bridgelux.</p> <p>LED VERO18</p> <p>FWHM / FWTM 22.0° / 58.0°</p> <p>Efficiency 91 %</p> <p>Peak intensity 3.6 cd/m</p> <p>LEDs/each optic 1</p> <p>Light colour White</p> <p>Required components: C13709_PF-SOCKET-VERO13-18</p>		
<p>bridgelux.</p> <p>LED Xenio Point 13mm</p> <p>FWHM / FWTM 14.0° / 33.0°</p> <p>Efficiency 91 %</p> <p>Peak intensity 6.6 cd/m</p> <p>LEDs/each optic 1</p> <p>Light colour White</p> <p>Required components: C13709_PF-SOCKET-VERO13-18</p>		
<p>bridgelux.</p> <p>LED Xenio Point 18mm</p> <p>FWHM / FWTM 21.0° / 60.0°</p> <p>Efficiency 86 %</p> <p>Peak intensity 3.2 cd/m</p> <p>LEDs/each optic 1</p> <p>Light colour White</p> <p>Required components: C13709_PF-SOCKET-VERO13-18</p>		

OPTICAL RESULTS (MEASURED):

CITIZEN

LED CLL02x/CLU02x (LES10)
 FWHM / FWTM 12.0° / 27.0°
 Efficiency 89 %
 Peak intensity 9.2 cd/lm
 LEDs/each optic 1
 Light colour White
 Required components:
 C13709_PF-SOCKET-VERO13-18
 Bender Wirth: 434 Typ L1

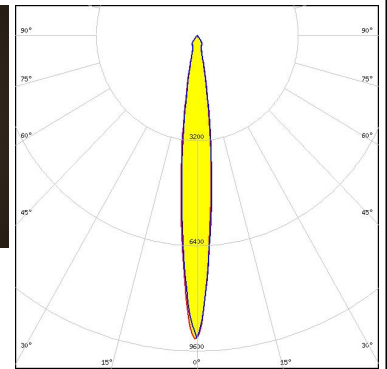

CITIZEN

LED CLL03x/CLU03x
 FWHM / FWTM 16.0° / 42.0°
 Efficiency 88 %
 Peak intensity 5.1 cd/lm
 LEDs/each optic 1
 Light colour White
 Required components:
 C13709_PF-SOCKET-VERO13-18
 Bender Wirth: 433 Typ L1

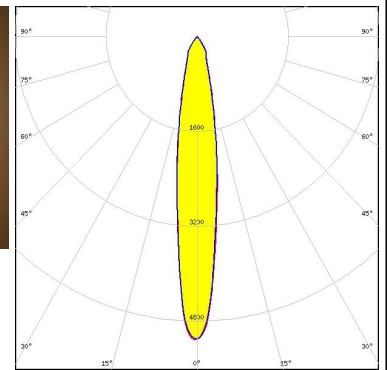
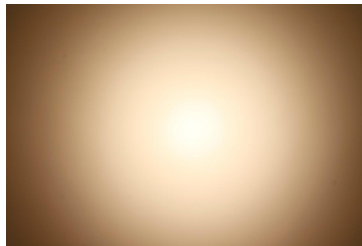

CITIZEN



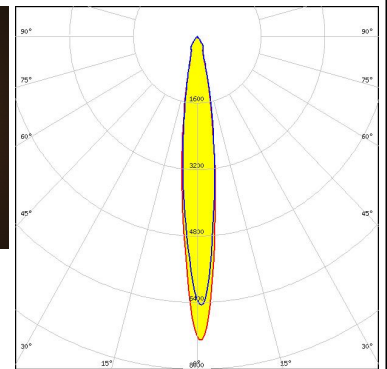
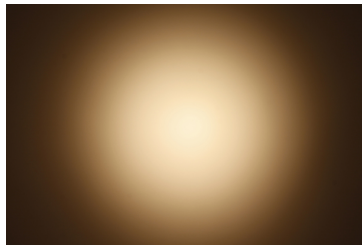

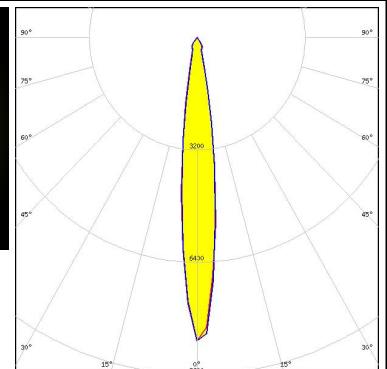

LED CLU720/721/723
 FWHM / FWTM 14.0° / 33.0°
 Efficiency 87 %
 Peak intensity 7.3 cd/lm
 LEDs/each optic 1
 Light colour White
 Required components:
 C13709_PF-SOCKET-VERO13-18
 Bender Wirth: 433 Typ L1



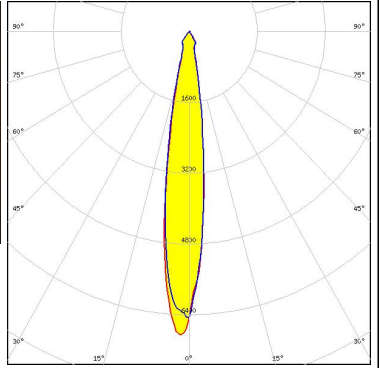

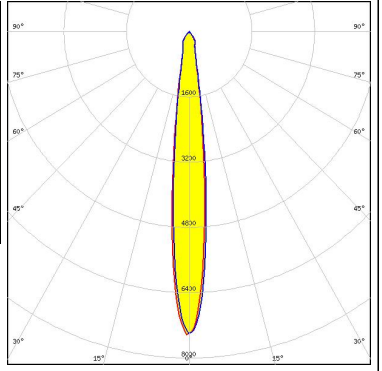

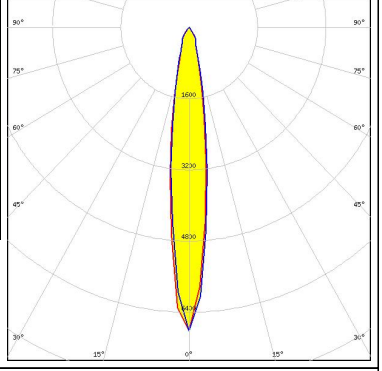

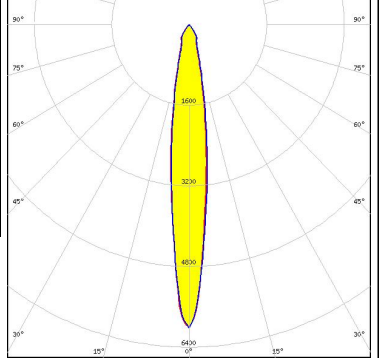
LED CXA/B 15xx
 FWHM / FWTM 14.0° / 29.0°
 Efficiency 91 %
 Peak intensity 8.6 cd/lm
 LEDs/each optic 1
 Light colour White
 Required components:
 C14115_PF-SOCKET-CXA15-18



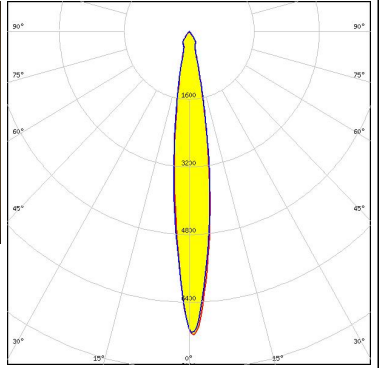

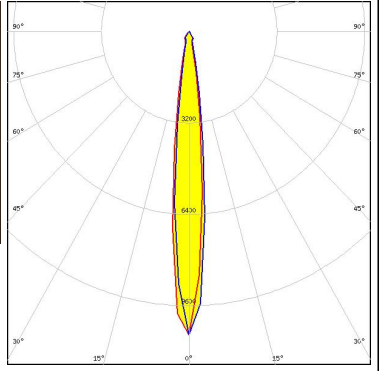

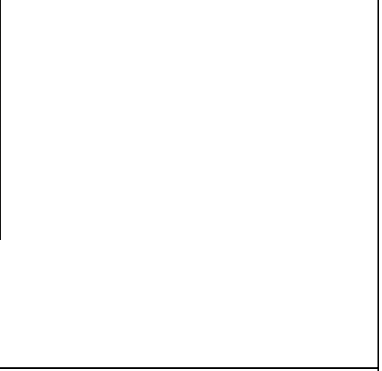
OPTICAL RESULTS (MEASURED):

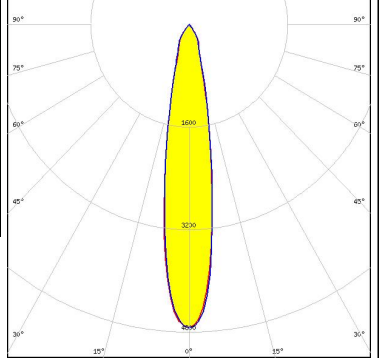
<p>CREE LEDs</p> <p>LED CXA/B 15xx FWHM / FWTM 15.0° / 30.0° Efficiency 89 % Peak intensity 6.9 cd/lm LEDs/each optic 1 Light colour White</p> <p>Required components: C13709_PF-SOCKET-VERO13-18 Bender Wirth: 441 Typ L1</p>		
<p>CREE LEDs</p> <p>LED CXA/B 15xx FWHM / FWTM 13.0° / 29.0° Efficiency 85 % Peak intensity 7.4 cd/lm LEDs/each optic 1 Light colour White</p> <p>Required components: C13083_PF-SOCKET C14658_BARBARA-RZ-LENS</p>		
<p>CREE LEDs</p> <p>LED CXA/B 1816 & CXA/B 1820 & CXA 1850 FWHM / FWTM 15.0° / 36.0° Efficiency 92 % Peak intensity 6.8 cd/lm LEDs/each optic 1 Light colour White</p> <p>Required components: C14115_PF-SOCKET-CXA15-18</p>		
<p>CREE LEDs</p> <p>LED CXA/B 1816 & CXA/B 1820 & CXA 1850 FWHM / FWTM 14.0° / 36.0° Efficiency 86 % Peak intensity 6.1 cd/lm LEDs/each optic 1 Light colour White</p> <p>Required components: C13709_PF-SOCKET-VERO13-18 Bender Wirth: 437 Typ L1</p>		



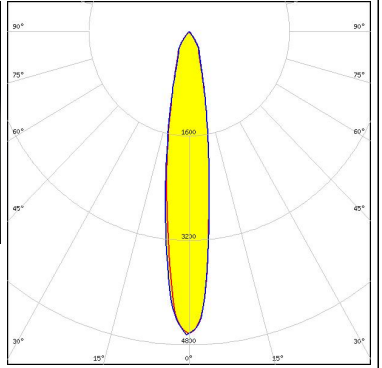

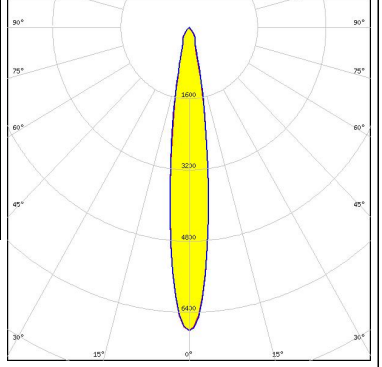
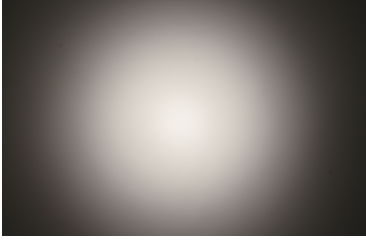
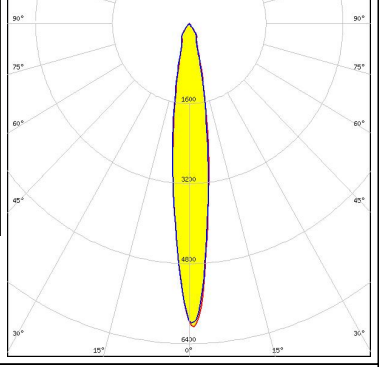
OPTICAL RESULTS (MEASURED):

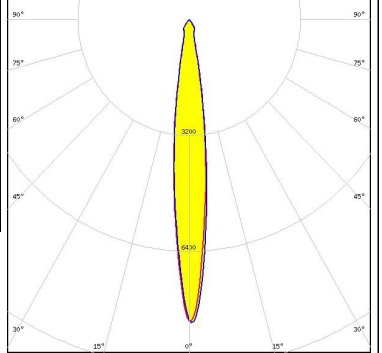
<p>LUMILEDS</p> <p>LED LUXEON CoB 1202/1203</p> <p>FWHM / FWTM 14.0° / 30.0°</p> <p>Efficiency 88 %</p> <p>Peak intensity 7.3 cd/lm</p> <p>LEDs/each optic 1</p> <p>Light colour White</p> <p>Required components: C13709_PF-SOCKET-VERO13-18 Bender Wirth: 438 Typ L1</p>		
<p>LUMILEDS</p> <p>LED LUXEON CoB 1202/1203</p> <p>FWHM / FWTM 12.0° / 25.0°</p> <p>Efficiency 90 %</p> <p>Peak intensity 10.6 cd/lm</p> <p>LEDs/each optic 1</p> <p>Light colour White</p> <p>Required components: C14037_PF-NSX-SOCKET</p>		
<p>LUMILEDS</p> <p>LED LUXEON CoB 1202s</p> <p>FWHM / FWTM 9.0° / 18.0°</p> <p>Efficiency 90 %</p> <p>Peak intensity 19.6 cd/lm</p> <p>LEDs/each optic 1</p> <p>Light colour White</p> <p>Required components: C13761_PF-SOCKET-CXA15</p>		
<p>NICHIA</p> <p>LED COB J-Type</p> <p>FWHM / FWTM 19.0° / 44.0°</p> <p>Efficiency 91 %</p> <p>Peak intensity 4.7 cd/lm</p> <p>LEDs/each optic 1</p> <p>Light colour White</p> <p>Required components: C14037_PF-NSX-SOCKET</p>		

OPTICAL RESULTS (MEASURED):

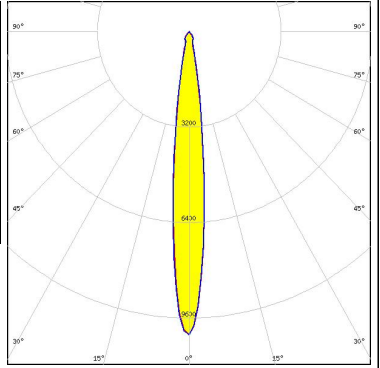
<p>NICHIA</p> <p>LED COB J-Type FWHM / FWTM 17.0° / 45.0° Efficiency 88 % Peak intensity 4.6 cd/m LEDs/each optic 1 Light colour White</p> <p>Required components: C13709_PF-SOCKET-VERO13-18 Bender Wirth: 463 Typ L2</p>		
<p>NICHIA</p> <p>LED COB L-Type (LES 11) FWHM / FWTM 15.0° / 33.0° Efficiency 90 % Peak intensity 6.8 cd/m LEDs/each optic 1 Light colour White</p> <p>Required components: C14037_PF-NSX-SOCKET</p>		
<p>NICHIA</p> <p>LED COB L-Type (LES 11) FWHM / FWTM 14.0° / 35.0° Efficiency 86 % Peak intensity 6.1 cd/m LEDs/each optic 1 Light colour White</p> <p>Required components: C13709_PF-SOCKET-VERO13-18 Bender Wirth: 438 Typ L1</p>		
<p>NICHIA</p> <p>LED COB L-Type (LES 9) FWHM / FWTM 13.0° / 27.0° Efficiency 90 % Peak intensity 8.4 cd/m LEDs/each optic 1 Light colour White</p> <p>Required components: C13709_PF-SOCKET-VERO13-18 Bender Wirth: 438 Typ L1</p>		

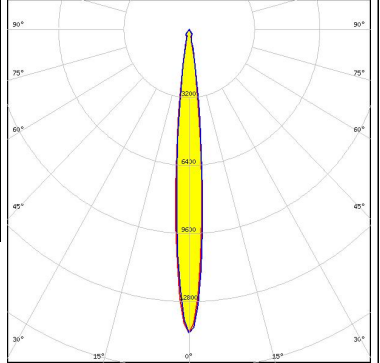
OPTICAL RESULTS (MEASURED):

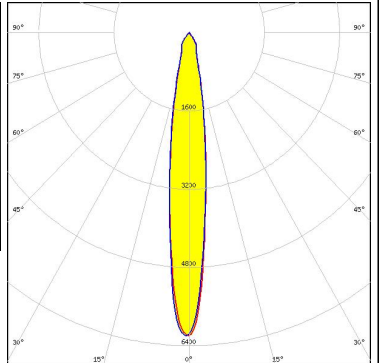
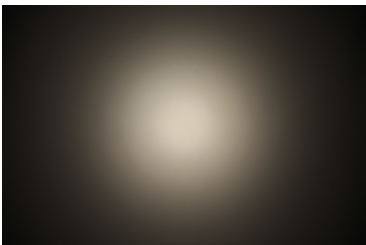
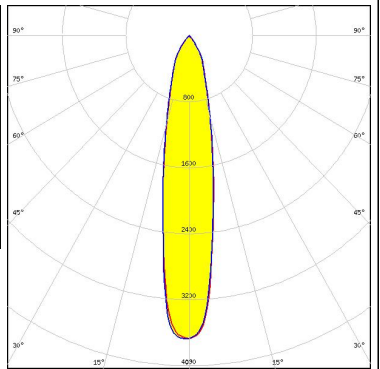
<p>NICHIA</p> <p>LED COB L-Type (LES 9)</p> <p>FWHM / FWTM 13.0° / 26.0°</p> <p>Efficiency 90 %</p> <p>Peak intensity 10.1 cd/lm</p> <p>LEDs/each optic 1</p> <p>Light colour White</p> <p>Required components: C14037_PF-NSX-SOCKET</p>		
<p>NICHIA</p> <p>LED NSCxL036A</p> <p>FWHM / FWTM 11.0° / 21.0°</p> <p>Efficiency 89 %</p> <p>Peak intensity 14.1 cd/lm</p> <p>LEDs/each optic 1</p> <p>Light colour White</p> <p>Required components: C14037_PF-NSX-SOCKET</p>		
<p>OSRAM Opto Semiconductors</p> <p>LED Soleriq S13</p> <p>FWHM / FWTM 14.0° / 35.0°</p> <p>Efficiency 89 %</p> <p>Peak intensity 6.2 cd/lm</p> <p>LEDs/each optic 1</p> <p>Light colour White</p> <p>Required components: C13709_PF-SOCKET-VERO13-18 Bender Wirth: 437 Typ L1</p>		
<p>SAMSUNG</p> <p>LED LC026B / 033B / 040B</p> <p>FWHM / FWTM 20.0° / 57.0°</p> <p>Efficiency 88 %</p> <p>Peak intensity 3.7 cd/lm</p> <p>LEDs/each optic 1</p> <p>Light colour White</p> <p>Required components: C13709_PF-SOCKET-VERO13-18 Bender Wirth: 450 Typ L2</p>		

OPTICAL RESULTS (MEASURED):

XICATO

LED XTM - 19mm LES
 FWHM / FWTM 20.0° / 58.0°
 Efficiency 88 %
 Peak intensity 3.6 cd/lm
 LEDs/each optic 1
 Light colour White
 Required components:
 C14636_XTM-PF-ADAPTER

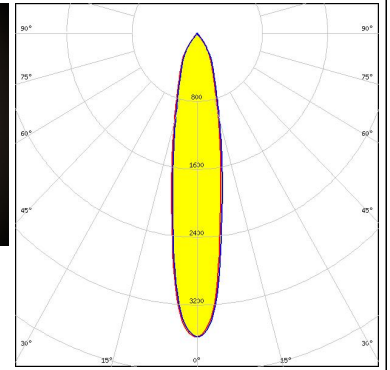

XICATO

LED XTM - 9mm LES
 FWHM / FWTM 12.0° / 26.0°
 Efficiency 90 %
 Peak intensity 9.3 cd/lm
 LEDs/each optic 1
 Light colour White
 Required components:
 C14636_XTM-PF-ADAPTER

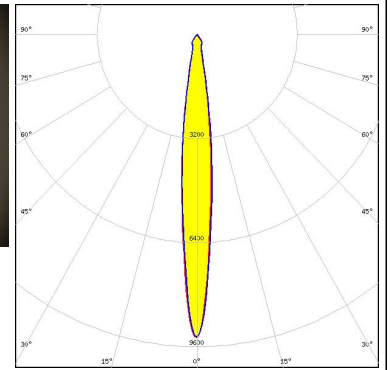

OPTICAL RESULTS (SIMULATED):



LED V10 Gen7
FWHM / FWTM 12.0° / 27.0°
Efficiency 91 %
Peak intensity 9.4 cd/lm
LEDs/each optic 1
Light colour White
Required components:
C13709_PF-SOCKET-VERO13-18
Bender Wirth: 486 Typ L1

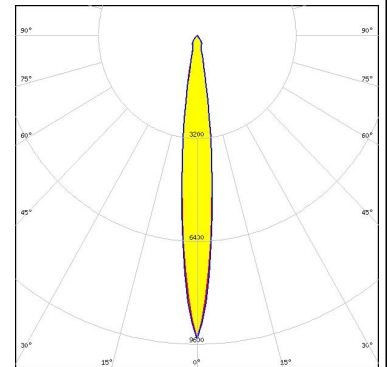

LED LUXEON CoB Compact
FWHM / FWTM 9.0° / 18.0°
Efficiency 90 %
Peak intensity 19.6 cd/lm
LEDs/each optic 1
Light colour White
Required components:
C13761_PF-SOCKET-CXA15



LED CxM-14 (19x19)
FWHM / FWTM 16.0° / 42.0°
Efficiency 88 %
Peak intensity 5.1 cd/lm
LEDs/each optic 1
Light colour White
Required components:
C13709_PF-SOCKET-VERO13-18
Bender Wirth: 433 Typ L1



LED CxM-9 (13.5x13.5)
FWHM / FWTM 12.0° / 27.0°
Efficiency 89 %
Peak intensity 9.2 cd/lm
LEDs/each optic 1
Light colour White
Required components:
C13709_PF-SOCKET-VERO13-18
Bender Wirth: 434 Typ L1

OPTICAL RESULTS (SIMULATED):

OSRAM

Opto Semiconductors

LED Soleriq S15
 FWHM / FWTM 20.0° / 47.0°
 Efficiency 88 %
 Peak intensity 4 cd/lm
 LEDs/each optic 1
 Light colour White
 Required components:
 C13709_PF-SOCKET-VERO13-18
 Bender Wirth: 433 Typ L1

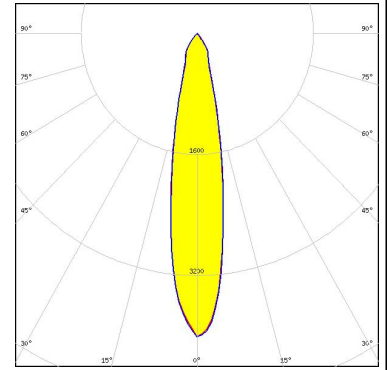

SAMSUNG

LED LC010C
 FWHM / FWTM 9.1° / 19.0°
 Efficiency 89 %
 Peak intensity 16.3 cd/lm
 LEDs/each optic 1
 Light colour White
 Required components:
 C13709_PF-SOCKET-VERO13-18
 Bender Wirth: 479 Typ L1

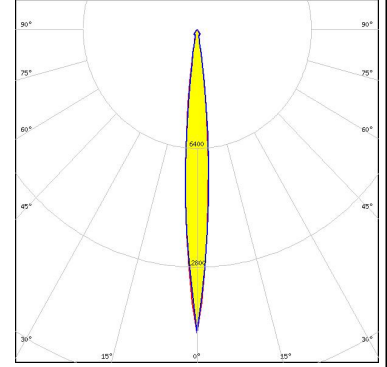

SAMSUNG

LED LC020C
 FWHM / FWTM 10.0° / 23.0°
 Efficiency 89 %
 Peak intensity 12.3 cd/lm
 LEDs/each optic 1
 Light colour White
 Required components:
 C13709_PF-SOCKET-VERO13-18
 Bender Wirth: 479 Typ L1

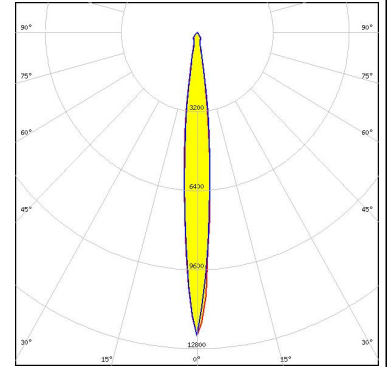

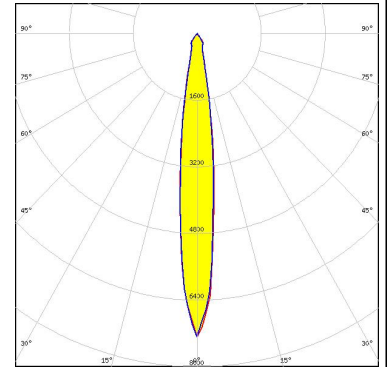

SAMSUNG

LED LC040C
 FWHM / FWTM 13.0° / 30.0°
 Efficiency 85 %
 Peak intensity 7.3 cd/lm
 LEDs/each optic 1
 Light colour White
 Required components:
 C13709_PF-SOCKET-VERO13-18
 Bender Wirth: 480 Typ L1



OPTICAL RESULTS (SIMULATED):

	
SEOL SEMICONDUCTOR	
LED	ZC12/18
FWHM / FWTM	16.0° / 42.0°
Efficiency	88 %
Peak intensity	5.1 cd/lm
LEDs/each optic	1
Light colour	White
Required components:	
C13709_PF-SOCKET-VERO13-18	
Bender Wirth: 433 Typ L1	
<hr/>	
	
SEOL SEMICONDUCTOR	
LED	ZC4/6
FWHM / FWTM	12.0° / 27.0°
Efficiency	89 %
Peak intensity	9.2 cd/lm
LEDs/each optic	1
Light colour	White
Required components:	
C13709_PF-SOCKET-VERO13-18	
Bender Wirth: 434 Typ L1	

GENERAL INFORMATION:

NOTE: The typical beam angle will be changed by different color, chip size and chip position tolerance. The typical total beam angle is the full angle measured where the luminous intensity is half of the peak value.

Due to use of high power COB's with this product, special attention to proper thermal design is highly recommended. LEDiL has no liability for direct, indirect or consecutive damages arising from the LEDiL products being used outside of the recommended temperature range.

MATERIALS:

As part of our continuous research and improvement processes, and to ensure the best possible quality and availability of our products, LEDiL reserves the right to change material grades without notice.

PRODUCT DATA USER AGREEMENT AND DISCLAIMER:

The measured data in the provided downloadable LEDiL Product Datasheets and Mechanical 2D-Drawings is rounded and provided as reference for planning. LEDiL Oy's optical specifications have been verified by conducting performance testing of the products in accordance with the company's quality system. The reported data are averaged results of multiple measurements with typical variation. LEDiL Oy reserves the right to without prior notification make changes and improvements to its products.

LEDiL Oy assumes neither warranty, nor guarantee nor any other liability of any kind for the contents and correctness of the provided data. The provided data has been generated with highest diligence but the provided data may in reality not represent the complete possible variation range of all intrinsic parameters. Therefore, in certain cases a deviation from the provided data could occur.

LEDiL Oy reserves the right to undertake technical changes of its products without further notification which could lead to changes in the provided data. LEDiL Oy assumes no liability of any kind for the possible deviation from any provided data or any other damage resulting from the usage of the provided data.

The user agrees to this disclaimer and user agreement with the download or usage of the provided files.

LEDiL Oy

Joensuunkatu 13
FI-24240 SALO
Finland

LEDiL Inc.

228 West Page Street
Suite D
Sycamore IL 60178
USA

Ledil Optics Technology (Shenzhen) Co., Ltd.

405 , Block B
Casic Motor Building
Shenzhen 518057
P.R.CHINA

Local sales and technical support

[www.ledil.com/
where_to_buy](http://www.ledil.com/where_to_buy)

Shipping locations

Salo, Finland
Hong Kong, China

Distribution Partners

[www.ledil.com/
where_to_buy](http://www.ledil.com/where_to_buy)