

## G2-LAURA-SS-P

~11° smooth spot beam. Assembly with thinner white holder, installation tape and location pins.

### SPECIFICATION:

Dimensions	21.6 x 21.6 mm
Height	13.1 mm
Fastening	tape, pin
ROHS compliant	yes ⓘ

### MATERIALS:

Component	Type	Material	Colour	Finish
LAURA-SS	Single lens	PMMA		
LAURA-LT-PIN-XP-HLD-WHT	Holder	PC	white	
ROSE-TAPE	Tape	Acrylic foam	black	

### ORDERING INFORMATION:

Component	Qty in box	MOQ	MPQ	Box weight (kg)
CA13630_G2-LAURA-SS-P » Box size:		360	180	6.0



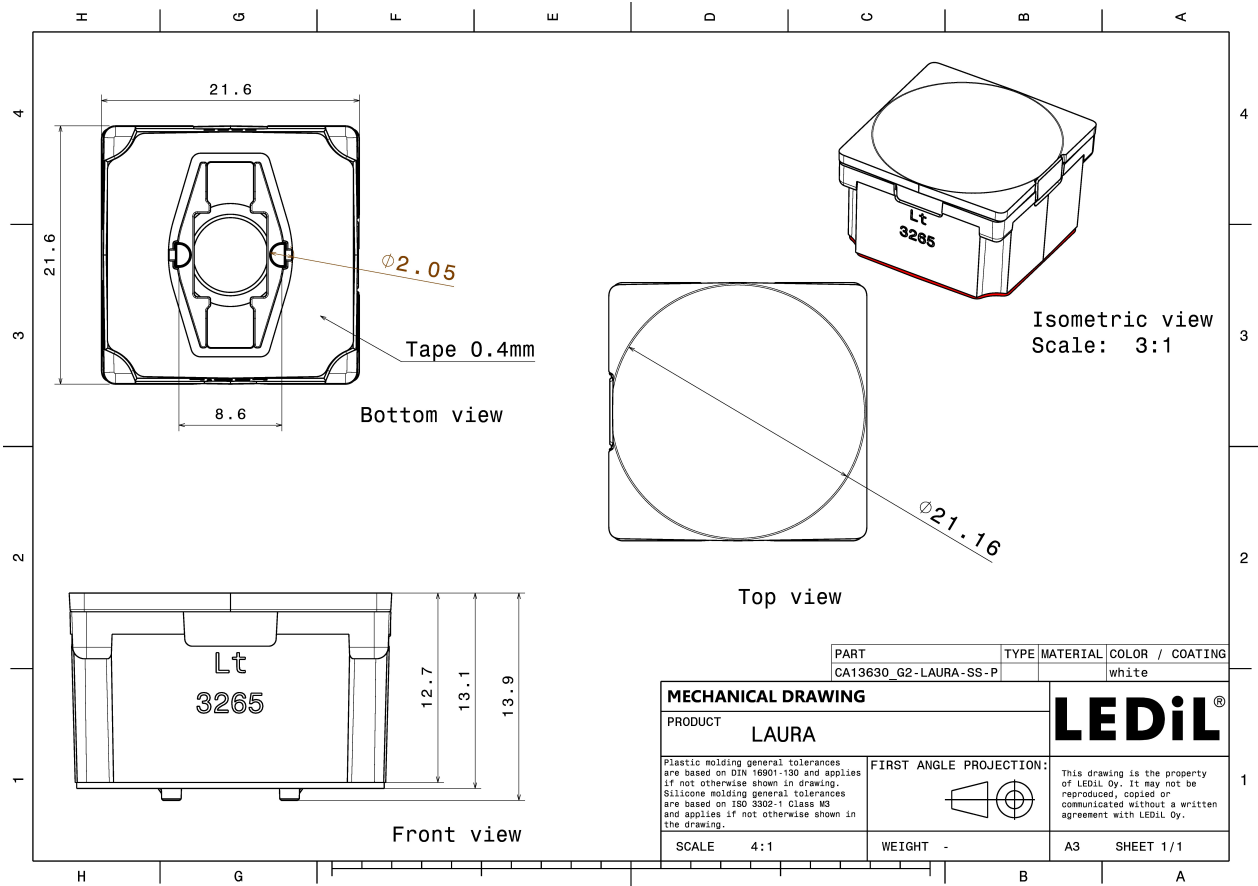

See also our general installation guide: [www.ledil.com/installation\\_guide](http://www.ledil.com/installation_guide)

#### OPTICAL RESULTS (MEASURED):



LED XB-D  
 FWHM / FWTM 13.0° / 24.0°  
 Efficiency 88 %  
 Peak intensity 13.5 cd/lm  
 LEDs/each optic 1  
 Light colour White  
 Required components:

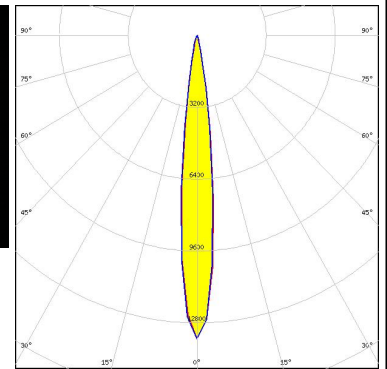
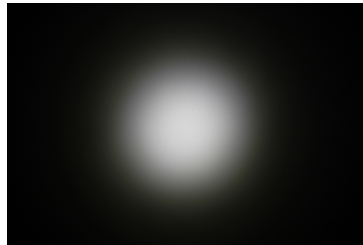

LED XB-H  
 FWHM / FWTM 13.0° / 25.0°  
 Efficiency 90 %  
 Peak intensity 13.3 cd/lm  
 LEDs/each optic 1  
 Light colour White  
 Required components:

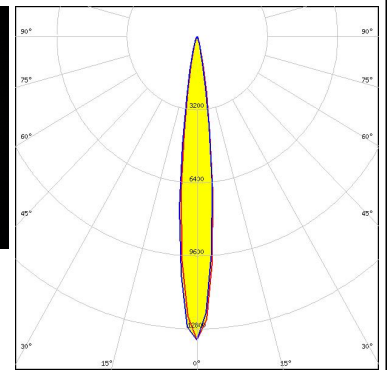





LED XP-E  
 FWHM / FWTM 11.0° / 19.0°  
 Efficiency 93 %  
 Peak intensity 16.5 cd/lm  
 LEDs/each optic 1  
 Light colour White  
 Required components:

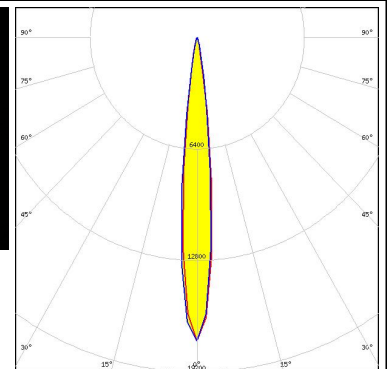

LED XP-E2  
 FWHM / FWTM 12.0° / 21.0°  
 Efficiency 90 %  
 Peak intensity 17.4 cd/lm  
 LEDs/each optic 1  
 Light colour White  
 Required components:

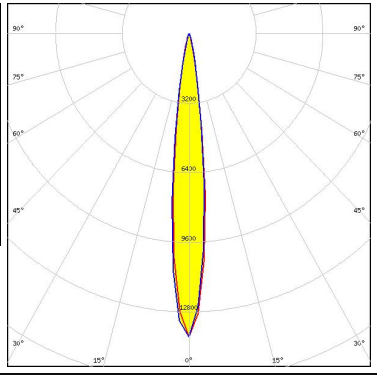
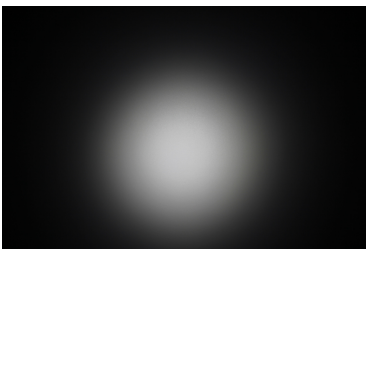
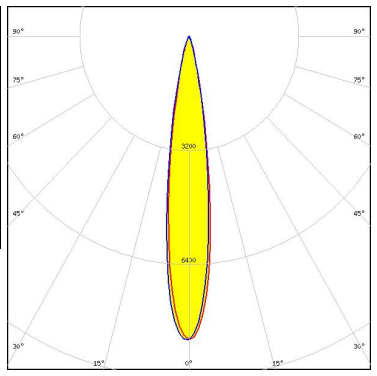

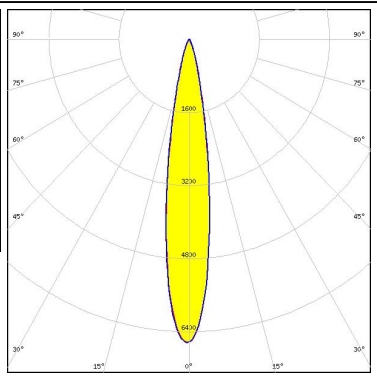
#### OPTICAL RESULTS (MEASURED):

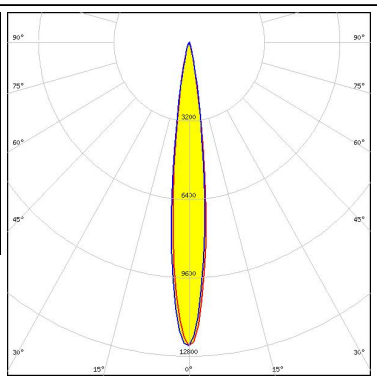
<p><b>CREE</b> LEDs</p> <p>LED                    XP-G2            FWHM / FWTM    13.0° / 24.0°            Efficiency            90 %            Peak intensity     14 cd/lm            LEDs/each optic   1            Light colour        White            Required components:</p>		
<p><b>CREE</b> LEDs</p> <p>LED                    XP-L HD            FWHM / FWTM    16.0° / 30.0°            Efficiency            89 %            Peak intensity     8.5 cd/lm            LEDs/each optic   1            Light colour        White            Required components:</p>		
<p><b>CREE</b> LEDs</p> <p>LED                    XP-L2            FWHM / FWTM    17.0° / 34.0°            Efficiency            88 %            Peak intensity     6.6 cd/lm            LEDs/each optic   1            Light colour        White            Required components:</p>		
<p><b>CREE</b> LEDs</p> <p>LED                    XT-E            FWHM / FWTM    13.0° / 25.0°            Efficiency            90 %            Peak intensity     12.4 cd/lm            LEDs/each optic   1            Light colour        White            Required components:</p>		

#### OPTICAL RESULTS (MEASURED):

##### LUMILEDS

LED LUXEON 3030 2D (Round LES)  
 FWHM / FWTM 13.0° / 26.0°  
 Efficiency 91 %  
 Peak intensity 11.4 cd/lm  
 LEDs/each optic 1  
 Light colour White  
 Required components:

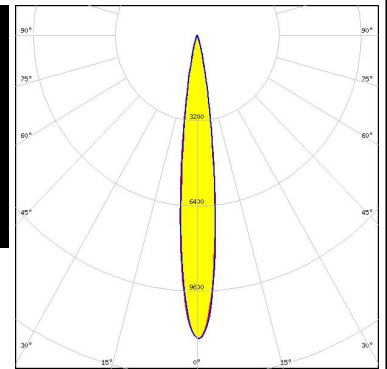

##### LUMILEDS

LED LUXEON TX  
 FWHM / FWTM 14.0° / 26.0°  
 Efficiency 90 %  
 Peak intensity 12.5 cd/lm  
 LEDs/each optic 1  
 Light colour White  
 Required components:

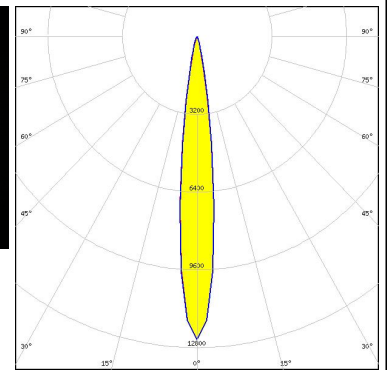

##### NICHIA

LED NCSxx19A  
 FWHM / FWTM 14.0° / 26.0°  
 Efficiency 91 %  
 Peak intensity 12.5 cd/lm  
 LEDs/each optic 1  
 Light colour White  
 Required components:

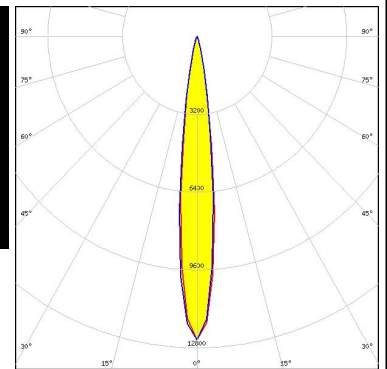





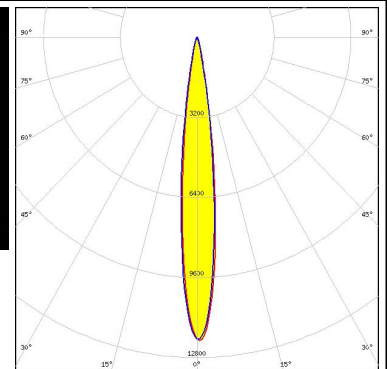

##### NICHIA

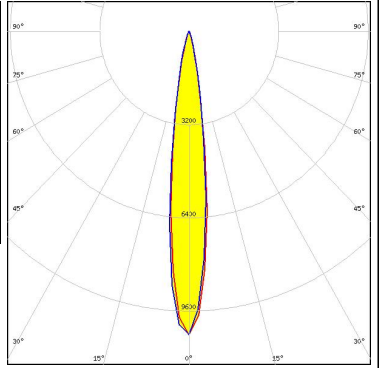

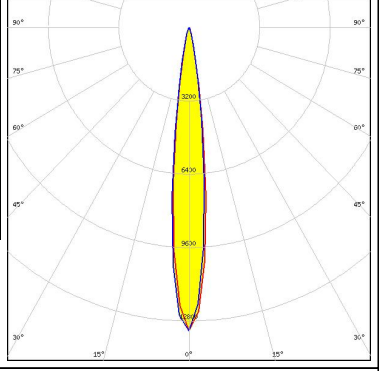

LED NVSW219D  
 FWHM / FWTM 13.0° / 25.0°  
 Efficiency 94 %  
 Peak intensity 12.2 cd/lm  
 LEDs/each optic 1  
 Light colour White  
 Required components:

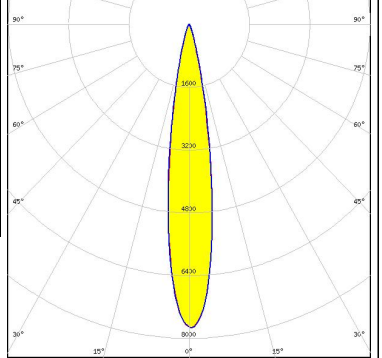

### OPTICAL RESULTS (MEASURED):

<p><b>NICHIA</b></p> <p>LED NVSxx19A            FWHM / FWTM 15.0° / 28.0°            Efficiency 88 %            Peak intensity 10.4 cd/lm            LEDs/each optic 1            Light colour White            Required components:</p>		
<p><b>NICHIA</b></p> <p>LED NVSxx19B/NVSxx19C            FWHM / FWTM 14.0° / 27.0°            Efficiency 89 %            Peak intensity 11.4 cd/lm            LEDs/each optic 1            Light colour White            Required components:</p>		
<p><b>OSRAM</b>  <small>Opto Semiconductors</small></p> <p>LED OSLON Square EC            FWHM / FWTM 13.0° / 25.0°            Efficiency 90 %            Peak intensity 13.2 cd/lm            LEDs/each optic 1            Light colour White            Required components:</p>		
<p><b>SAMSUNG</b></p> <p>LED LH351D            FWHM / FWTM 17.0° / 32.0°            Efficiency 94 %            Peak intensity 7.7 cd/lm            LEDs/each optic 1            Light colour White            Required components:</p>		

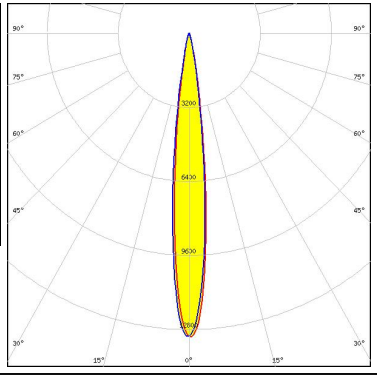
## OPTICAL RESULTS (MEASURED):

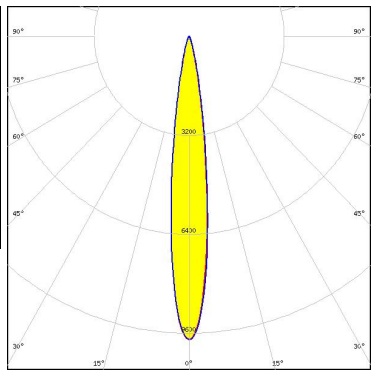
<p> SEOUL SEMICONDUCTOR</p> <p>LED Z5M1/Z5M2</p> <p>FWHM / FWTM 12.0° / 24.0°</p> <p>Efficiency 90 %</p> <p>Peak intensity 13.1 cd/lm</p> <p>LEDs/each optic 1</p> <p>Light colour White</p> <p>Required components:</p>		
<p> SEOUL SEMICONDUCTOR</p> <p>LED Z5M3</p> <p>FWHM / FWTM 14.0° / 28.0°</p> <p>Efficiency 94 %</p> <p>Peak intensity 9.8 cd/lm</p> <p>LEDs/each optic 1</p> <p>Light colour White</p> <p>Required components:</p>		

#### OPTICAL RESULTS (SIMULATED):



LED XHP35 HI  
 FWHM / FWTM 14.0° / 26.0°  
 Efficiency 94 %  
 Peak intensity 12.8 cd/lm  
 LEDs/each optic 1  
 Light colour White  
 Required components:

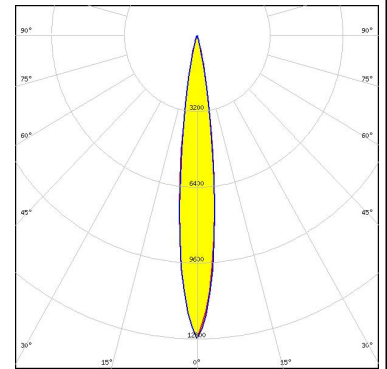

LED XP-E2  
 FWHM / FWTM 12.0° / 23.0°  
 Efficiency 95 %  
 Peak intensity 17.2 cd/lm  
 LEDs/each optic 1  
 Light colour Amber  
 Required components:

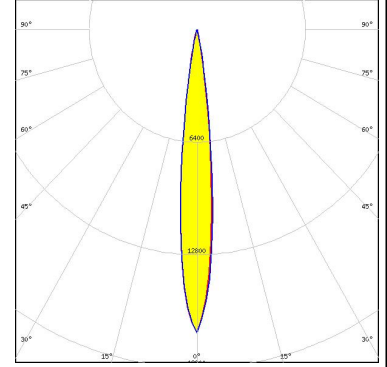

LED XP-G3  
 FWHM / FWTM 15.0° / 29.0°  
 Efficiency 93 %  
 Peak intensity 9.3 cd/lm  
 LEDs/each optic 1  
 Light colour White  
 Required components:

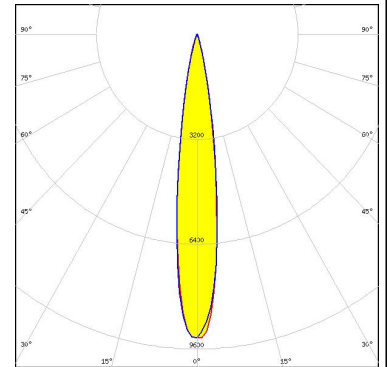

LED XQ-E HD  
 FWHM / FWTM 12.0° / 21.6°  
 Efficiency 94 %  
 Peak intensity 18.5 cd/lm  
 LEDs/each optic 1  
 Light colour White  
 Required components:

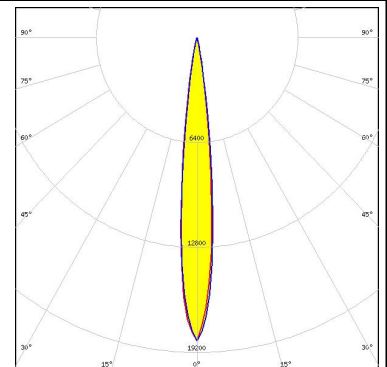

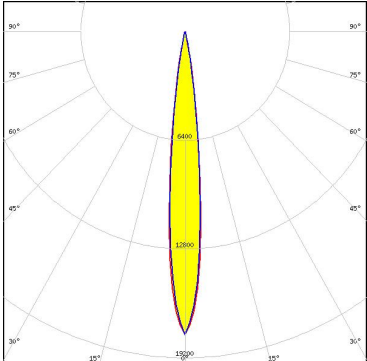
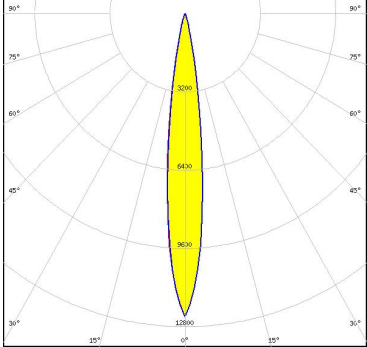
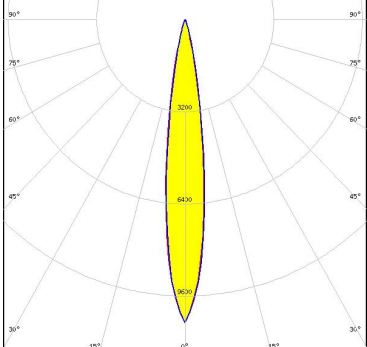
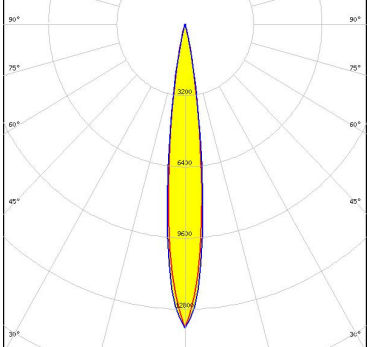

#### OPTICAL RESULTS (SIMULATED):

<p><b>LUMILEDS</b></p> <p>LED: LUXEON HL1Z            FWHM / FWTM: 12.0° / 22.0°            Efficiency: 96 %            Peak intensity: 17.9 cd/lm            LEDs/each optic: 1            Light colour: White            Required components:</p>	
<p><b>LUMILEDS</b></p> <p>LED: LUXEON HL2X            FWHM / FWTM: 14.0° / 26.0°            Efficiency: 94 %            Peak intensity: 12.4 cd/lm            LEDs/each optic: 1            Light colour: White            Required components:</p>	
<p><b>LUMILEDS</b></p> <p>LED: LUXEON HL2X-P            FWHM / FWTM: 15.0° / 28.0°            Efficiency: 94 %            Peak intensity: 10.5 cd/lm            LEDs/each optic: 1            Light colour: White            Required components:</p>	
<p><b>OSRAM</b>  <small>Opto Semiconductors</small></p> <p>LED: OSOLON Black            FWHM / FWTM: 13.0° / 25.0°            Efficiency: 96 %            Peak intensity: 13.8 cd/lm            LEDs/each optic: 1            Light colour: White            Required components:</p>	

#### OPTICAL RESULTS (SIMULATED):

<b>OSRAM</b> <small>Opto Semiconductors</small>	<p>LED OSLON Black Flat (LUW HWQP)</p> <p>FWHM / FWTM 11.0° / 20.0°</p> <p>Efficiency 94 %</p> <p>Peak intensity 21.3 cd/lm</p> <p>LEDs/each optic 1</p> <p>Light colour White</p> <p>Required components:</p>		
<b>OSRAM</b> <small>Opto Semiconductors</small>	<p>LED OSLON Signal</p> <p>FWHM / FWTM 12.0° / 20.0°</p> <p>Efficiency 96 %</p> <p>Peak intensity 20.5 cd/lm</p> <p>LEDs/each optic 1</p> <p>Light colour Red</p> <p>Required components:</p>		
<b>OSRAM</b> <small>Opto Semiconductors</small>	<p>LED OSLON Square CSSRM2/CSSRM3</p> <p>FWHM / FWTM 18.0° / 35.0 + 33.0°</p> <p>Efficiency 96 %</p> <p>Peak intensity 7.4 cd/lm</p> <p>LEDs/each optic 1</p> <p>Light colour White</p> <p>Required components:</p>		
<b>OSRAM</b> <small>Opto Semiconductors</small>	<p>LED OSLON Square Flat</p> <p>FWHM / FWTM 12.0° / 22.0°</p> <p>Efficiency 94 %</p> <p>Peak intensity 17.2 cd/lm</p> <p>LEDs/each optic 1</p> <p>Light colour White</p> <p>Required components:</p>		

### OPTICAL RESULTS (SIMULATED):

#### OSRAM Opto Semiconductors

LED SFH 4770S  
FWHM / FWTM 13.0° / 28.0°  
Efficiency 94 %  
LEDs/each optic 1  
Light colour White  
Required components:



#### SEOUL SEMICONDUCTOR

LED Z8Y22P  
FWHM / FWTM 13.0° / 26.0°  
Efficiency 97 %  
Peak intensity 11.9 cd/lm  
LEDs/each optic 1  
Light colour White  
Required components:

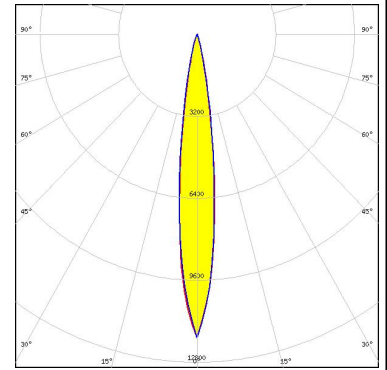

### GENERAL INFORMATION:

NOTE: The typical beam angle will be changed by different color, chip size and chip position tolerance. The typical total beam angle is the full angle measured where the luminous intensity is half of the peak value.

### MATERIALS:

As part of our continuous research and improvement processes, and to ensure the best possible quality and availability of our products, LEDiL reserves the right to change material grades without notice.

### PRODUCT DATA USER AGREEMENT AND DISCLAIMER:

The measured data in the provided downloadable LEDiL Product Datasheets and Mechanical 2D-Drawings is rounded and provided as reference for planning. LEDiL Oy's optical specifications have been verified by conducting performance testing of the products in accordance with the company's quality system. The reported data are averaged results of multiple measurements with typical variation. LEDiL Oy reserves the right to without prior notification make changes and improvements to its products.

LEDiL Oy assumes neither warranty, nor guarantee nor any other liability of any kind for the contents and correctness of the provided data. The provided data has been generated with highest diligence but the provided data may in reality not represent the complete possible variation range of all intrinsic parameters. Therefore, in certain cases a deviation from the provided data could occur.

LEDiL Oy reserves the right to undertake technical changes of its products without further notification which could lead to changes in the provided data. LEDiL Oy assumes no liability of any kind for the possible deviation from any provided data or any other damage resulting from the usage of the provided data.

The user agrees to this disclaimer and user agreement with the download or usage of the provided files.

#### LEDiL Oy

Joensuunkatu 13  
FI-24240 SALO  
Finland

#### LEDiL Inc.

228 West Page Street  
Suite D  
Sycamore IL 60178  
USA

#### Ledil Optics Technology (Shenzhen) Co., Ltd.

# 405 , Block B  
Casic Motor Building  
Shenzhen 518057  
P.R.CHINA

#### Local sales and technical support

[www.ledil.com/  
where\\_to\\_buy](http://www.ledil.com/where_to_buy)

#### Shipping locations

Salo, Finland  
Hong Kong, China

#### Distribution Partners

[www.ledil.com/  
where\\_to\\_buy](http://www.ledil.com/where_to_buy)