

## VERONICA-RS

~12° spot beam

### SPECIFICATION:

Dimensions	Ø 26.0 mm
Height	12.2 mm
Fastening	glue, pin
ROHS compliant	yes ⓘ

### MATERIALS:

Component	Type	Material	Colour	Finish
VERONICA-RS	Single lens	PMMA	clear	



### ORDERING INFORMATION:

Component	Qty in box	MOQ	MPQ	Box weight (kg)
C13528_VERONICA-RS » Box size: 480 x 280 x 300 mm	2240	336	112	11.1

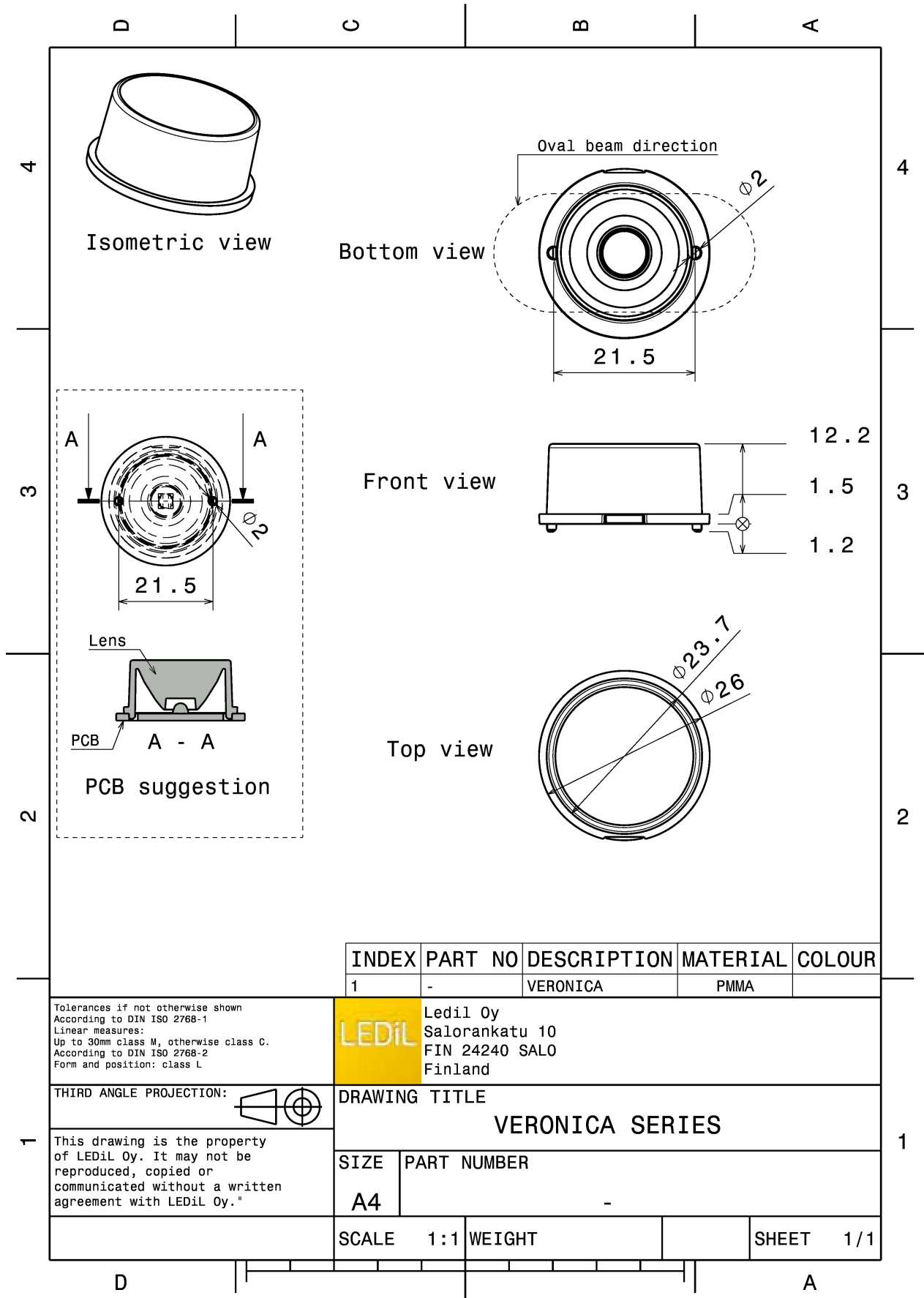

INDEX	PART NO	DESCRIPTION	MATERIAL	COLOUR
1	-	VERONICA	PMMA	

Tolerances if not otherwise shown  
According to DIN ISO 2768-1  
Linear measures:  
Up to 30mm class M, otherwise class C.  
According to DIN ISO 2768-2  
Form and position: class L

**LEDiL** LediL Oy  
Salorankatu 10  
FIN 24240 SALO  
Finland

THIRD ANGLE PROJECTION:

DRAWING TITLE  
**VERONICA SERIES**







This drawing is the property of LEDiL Oy. It may not be reproduced, copied or communicated without a written agreement with LEDiL Oy."

SIZE	PART NUMBER
A4	-

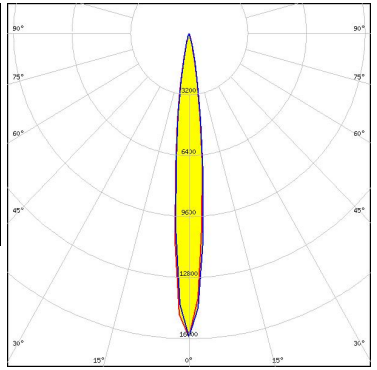
SCALE	1:1	WEIGHT	SHEET	1/1
-------	-----	--------	-------	-----

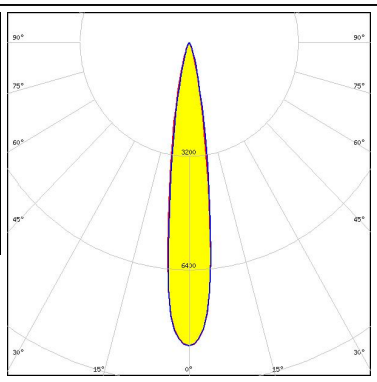
See also our general installation guide: [www.ledil.com/installation\\_guide](http://www.ledil.com/installation_guide)

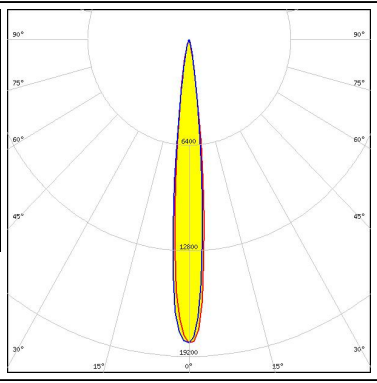
#### OPTICAL RESULTS (MEASURED):

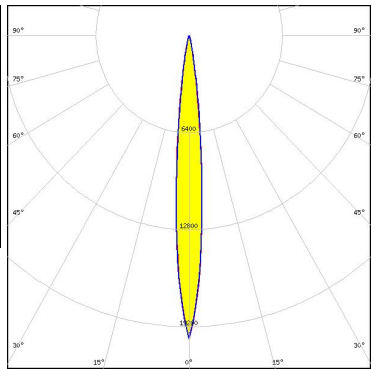
<p><b>CREE</b> → <b>LED</b></p> <p>LED XB-H            FWHM / FWTM 11.0° / 24.0°            Efficiency 89 %            Peak intensity 15.9 cd/lm            LEDs/each optic 1            Light colour White            Required components:</p>		
<p><b>CREE</b> → <b>LED</b></p> <p>LED XM-L2            FWHM / FWTM 16.0° / 32.0°            Efficiency 90 %            Peak intensity 8.5 cd/lm            LEDs/each optic 1            Light colour White            Required components:</p>		
<p><b>CREE</b> → <b>LED</b></p> <p>LED XP-G            FWHM / FWTM 12.0° / 22.0°            Efficiency 90 %            Peak intensity 18.4 cd/lm            LEDs/each optic 1            Light colour White            Required components:</p>		
<p><b>CREE</b> → <b>LED</b></p> <p>LED XP-G2            FWHM / FWTM 10.0° / 21.0°            Efficiency 90 %            Peak intensity 19 cd/lm            LEDs/each optic 1            Light colour White            Required components:</p>		

### OPTICAL RESULTS (MEASURED):

#### LUMILEDS

LED LUXEON A  
 FWHM / FWTM 13.0° / 25.0°  
 Efficiency 89 %  
 Peak intensity 14.7 cd/lm  
 LEDs/each optic 1  
 Light colour White  
 Required components:

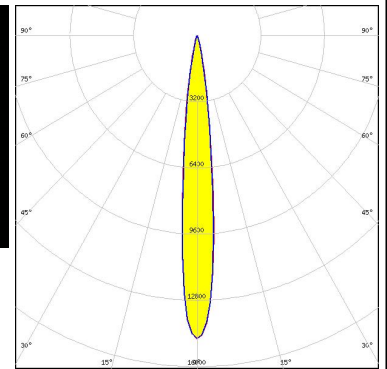

#### LUMILEDS

LED LUXEON Rebel  
 FWHM / FWTM 12.0° / 25.0°  
 Efficiency 88 %  
 Peak intensity 14.9 cd/lm  
 LEDs/each optic 1  
 Light colour White  
 Required components:

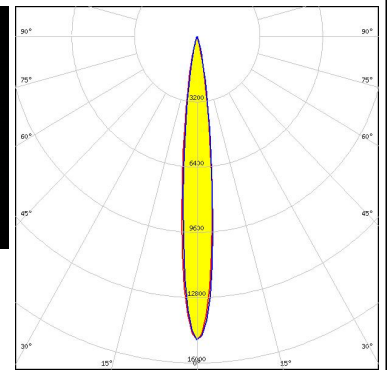

#### LUMILEDS

LED LUXEON V2  
 FWHM / FWTM 12.0° / 25.0°  
 Efficiency 94 %  
 Peak intensity 13.5 cd/lm  
 LEDs/each optic 1  
 Light colour White  
 Required components:

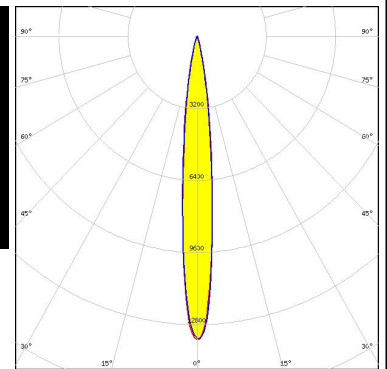





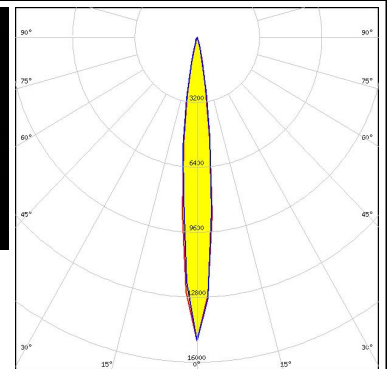

#### NICHIA

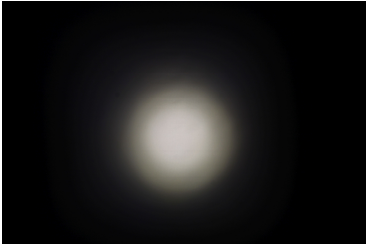
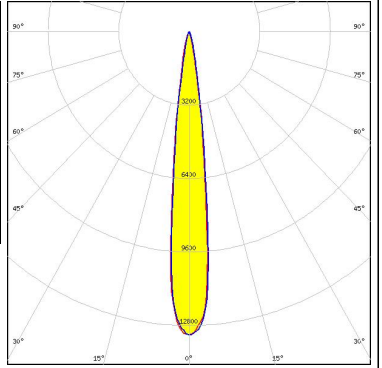
LED NCSxx19A  
 FWHM / FWTM 13.0° / 25.0°  
 Efficiency 86 %  
 Peak intensity 15 cd/lm  
 LEDs/each optic 1  
 Light colour White  
 Required components:

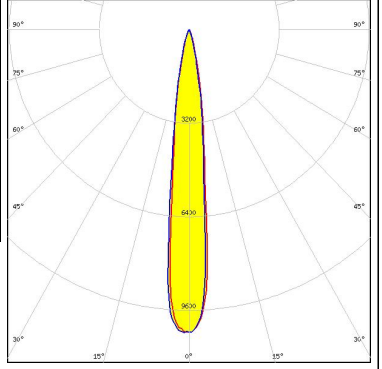

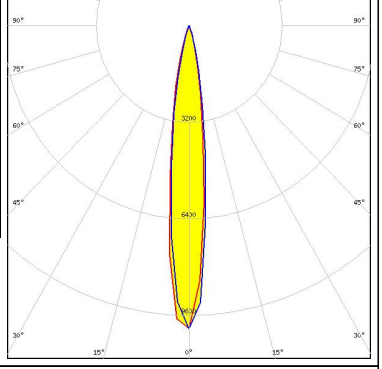
#### OPTICAL RESULTS (MEASURED):

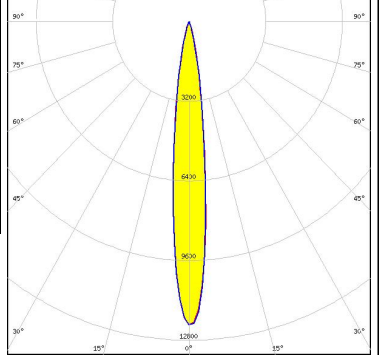
<p><b>NICHIA</b></p> <p>LED NVSW219F            FWHM / FWTM 13.0° / 24.0°            Efficiency 94 %            Peak intensity 13.3 cd/lm            LEDs/each optic 1            Light colour White            Required components:</p>		
<p><b>NICHIA</b></p> <p>LED NVSW3x9A            FWHM / FWTM 13.0° / 28.0°            Efficiency 89 %            Peak intensity 10.3 cd/lm            LEDs/each optic 1            Light colour White            Required components:</p>		
<p><b>NICHIA</b></p> <p>LED NVSxx19A            FWHM / FWTM 14.0° / 31.0°            Efficiency 85 %            Peak intensity 10 cd/lm            LEDs/each optic 1            Light colour White            Required components:</p>		
<p><b>NICHIA</b></p> <p>LED NVSxx19B/NVSxx19C            FWHM / FWTM 13.0° / 28.0°            Efficiency 87 %            Peak intensity 12.2 cd/lm            LEDs/each optic 1            Light colour White            Required components:</p>		

#### OPTICAL RESULTS (MEASURED):

### SAMSUNG

LED LH351Z  
 FWHM / FWTM 11.0° / 21.0°  
 Efficiency 89 %  
 Peak intensity 19.9 cd/lm  
 LEDs/each optic 1  
 Light colour White  
 Required components:

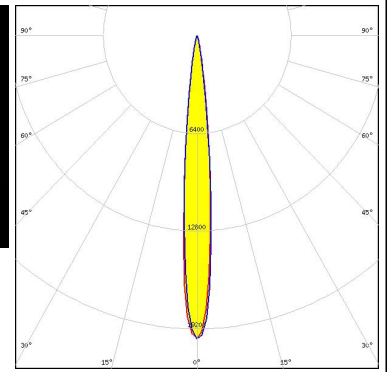

SEOUL SEMICONDUCTOR

LED Z8Y22P  
 FWHM / FWTM 11.0° / 29.0°  
 Efficiency 87 %  
 Peak intensity 10.4 cd/lm  
 LEDs/each optic 1  
 Light colour White  
 Required components:

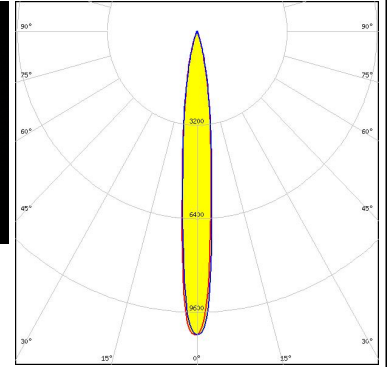
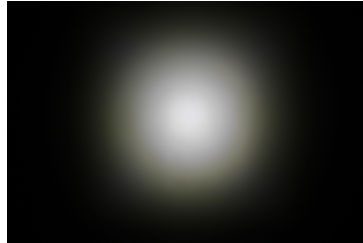

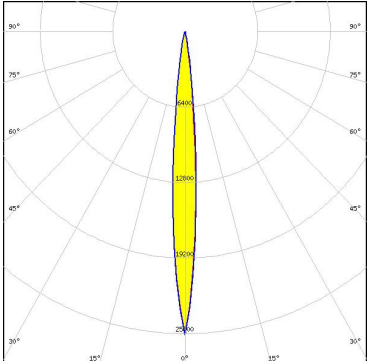
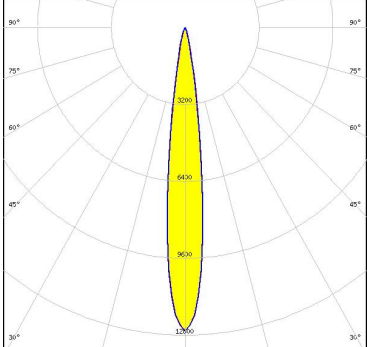
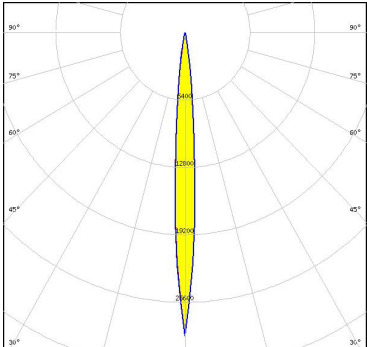
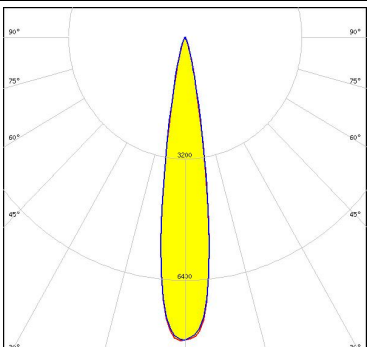

### OPTICAL RESULTS (SIMULATED):

<p><b>CREE</b> → <b>LED</b></p> <p>LED: XP-E2            FWHM / FWTM: 9.0° / 19.0°            Efficiency: 96 %            Peak intensity: 25.7 cd/lm            LEDs/each optic: 1            Light colour: Amber            Required components:</p>	
<p><b>CREE</b> → <b>LED</b></p> <p>LED: XP-G2 HE            FWHM / FWTM: 14.0° / 26.0°            Efficiency: 97 %            Peak intensity: 12.6 cd/lm            LEDs/each optic: 1            Light colour: White            Required components:</p>	
<p><b>NICHIA</b></p> <p>LED: NCSxE17A            FWHM / FWTM: 8.0° / 18.0°            Efficiency: 94 %            Peak intensity: 28.8 cd/lm            LEDs/each optic: 1            Light colour: White            Required components:</p>	
<p><b>NICHIA</b></p> <p>LED: NV4WB35AM            FWHM / FWTM: 18.0° / 31.0°            Efficiency: 96 %            Peak intensity: 8 cd/lm            LEDs/each optic: 1            Light colour: White            Required components:</p>	

#### OPTICAL RESULTS (SIMULATED):

<p><b>NICHIA</b></p> <p>LED: NV4WB35AM            FWHM / FWTM: 18.0° / 31.0°            Efficiency: 97 %            Peak intensity: 8.1 cd/lm            LEDs/each optic: 1            Light colour: White            Required components:</p>	
<p><b>NICHIA</b></p> <p>LED: NVSW519A            FWHM / FWTM: 16.0 + 15.0° / 30.0 + 29.0°            Efficiency: 95 %            Peak intensity: 9.2 cd/lm            LEDs/each optic: 1            Light colour: White            Required components:</p>	
<p><b>NICHIA</b></p> <p>LED: NVSW719AC            Assembly: NULL            FWHM / FWTM: 12.0° / 20.0°            Efficiency: 96 %            Peak intensity: 18.9 cd/lm            LEDs/each optic: 1            Light colour: White            Required components:</p>	
<p><b>NICHIA</b></p> <p>LED: NVSxE21A            FWHM / FWTM: 10.0° / 21.0°            Efficiency: 95 %            Peak intensity: 20.5 cd/lm            LEDs/each optic: 1            Light colour: White            Required components:</p>	



#### OPTICAL RESULTS (SIMULATED):

#### OSRAM

Opto Semiconductors

LED OSCONIQ P 3737 (3W version)  
 FWHM / FWTM 15.0° / 28.0°  
 Efficiency 94 %  
 Peak intensity 10.5 cd/lm  
 LEDs/each optic 1  
 Light colour White  
 Required components:

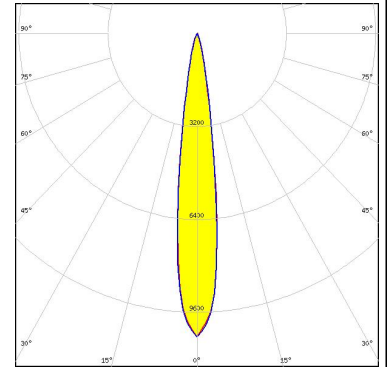

#### OSRAM

Opto Semiconductors

LED OSLON Square CSSRM2/CSSRM3  
 FWHM / FWTM 9.9° / 20.0°  
 Efficiency 94 %  
 Peak intensity 21.3 cd/lm  
 LEDs/each optic 1  
 Light colour White  
 Required components:

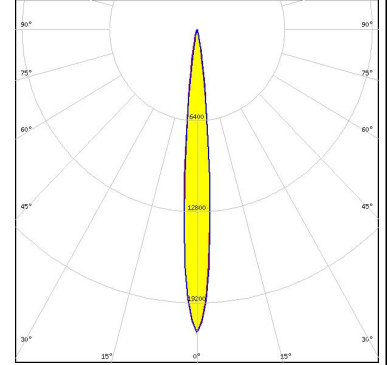

#### SAMSUNG

LED LH351B  
 FWHM / FWTM 12.0°  
 Efficiency %  
 LEDs/each optic 1  
 Light colour White  
 Required components:

#### SEOUL SEMICONDUCTOR

LED MJT 3030  
 FWHM / FWTM 10.0° / 20.0°  
 Efficiency 96 %  
 Peak intensity 22.1 cd/lm  
 LEDs/each optic 1  
 Light colour White  
 Required components:

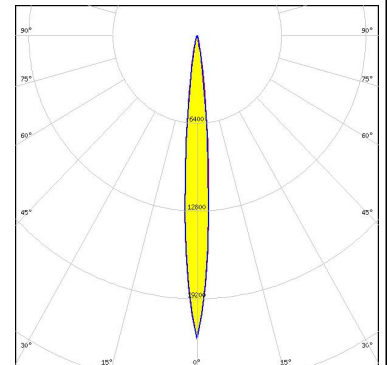

### OPTICAL RESULTS (SIMULATED):



### GENERAL INFORMATION:

NOTE: The typical beam angle will be changed by different color, chip size and chip position tolerance. The typical total beam angle is the full angle measured where the luminous intensity is half of the peak value.

### MATERIALS:

As part of our continuous research and improvement processes, and to ensure the best possible quality and availability of our products, LEDiL reserves the right to change material grades without notice.

### PRODUCT DATA USER AGREEMENT AND DISCLAIMER:

The measured data in the provided downloadable LEDiL Product Datasheets and Mechanical 2D-Drawings is rounded and provided as reference for planning. LEDiL Oy's optical specifications have been verified by conducting performance testing of the products in accordance with the company's quality system. The reported data are averaged results of multiple measurements with typical variation. LEDiL Oy reserves the right to without prior notification make changes and improvements to its products.

LEDiL Oy assumes neither warranty, nor guarantee nor any other liability of any kind for the contents and correctness of the provided data. The provided data has been generated with highest diligence but the provided data may in reality not represent the complete possible variation range of all intrinsic parameters. Therefore, in certain cases a deviation from the provided data could occur.

LEDiL Oy reserves the right to undertake technical changes of its products without further notification which could lead to changes in the provided data. LEDiL Oy assumes no liability of any kind for the possible deviation from any provided data or any other damage resulting from the usage of the provided data.

The user agrees to this disclaimer and user agreement with the download or usage of the provided files.

#### LEDiL Oy

Joensuunkatu 13  
FI-24240 SALO  
Finland

#### LEDiL Inc.

228 West Page Street  
Suite D  
Sycamore IL 60178  
USA

#### Ledil Optics Technology (Shenzhen) Co., Ltd.

# 405 , Block B  
Casic Motor Building  
Shenzhen 518057  
P.R.CHINA

#### Local sales and technical support

[www.ledil.com/  
where\\_to\\_buy](http://www.ledil.com/where_to_buy)

#### Shipping locations

Salo, Finland  
Hong Kong, China

#### Distribution Partners

[www.ledil.com/  
where\\_to\\_buy](http://www.ledil.com/where_to_buy)