

## EMERALD-A

Asymmetric beam. Assembly with installation tape.

### SPECIFICATION:

Dimensions	Ø 21.6 mm
Height	7.3 mm
Fastening	tape, pin
ROHS compliant	yes ⓘ



### MATERIALS:

Component	Type	Material	Colour	Finish
EMERALD-A	Single lens	PMMA	clear	
HEIDI-TAPE	Tape	Acrylic foam	black	

### ORDERING INFORMATION:

Component		Qty in box	MOQ	MPQ	Box weight (kg)
CA13156_EMERALD-A	Single lens	2128	336	112	4.9
» Box size: 480 x 280 x 300 mm					

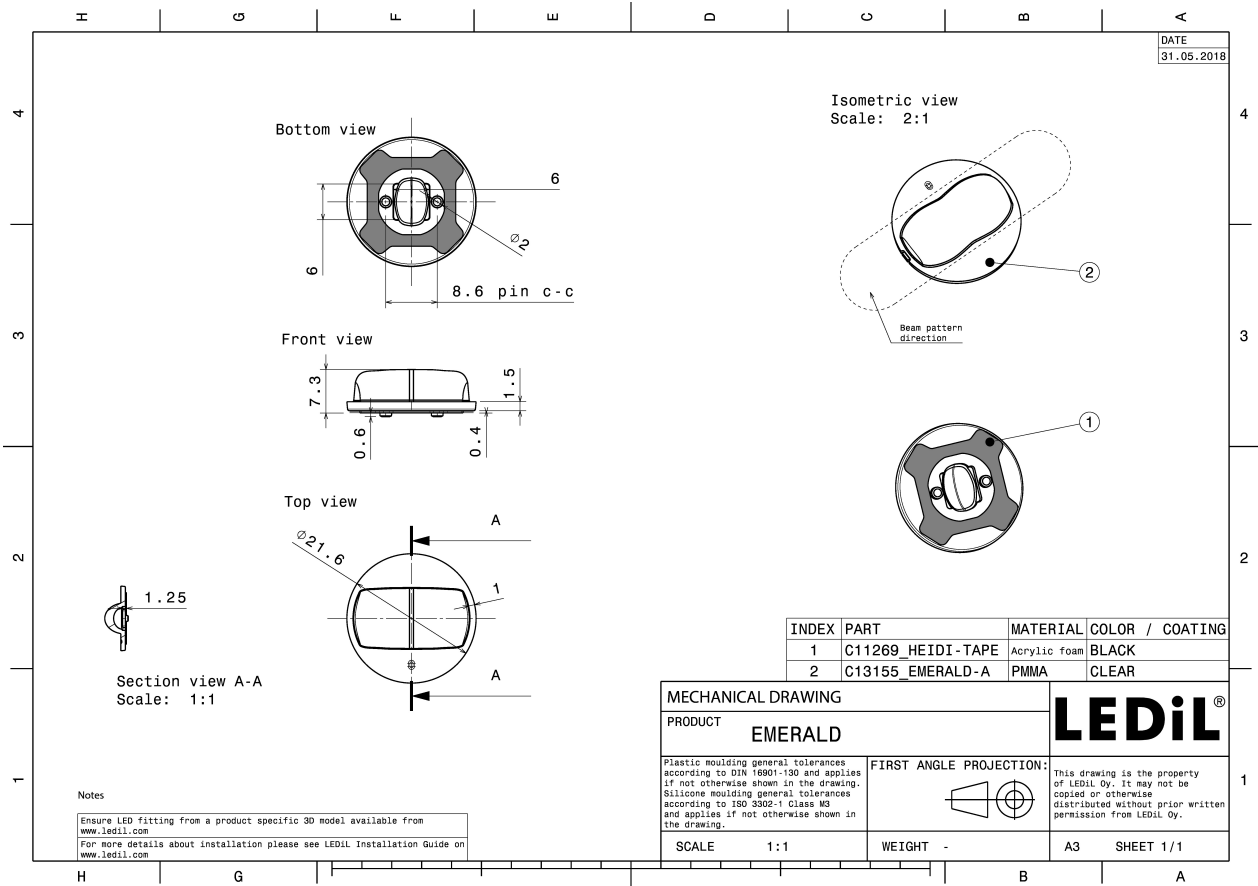

See also our general installation guide: [www.ledil.com/installation\\_guide](http://www.ledil.com/installation_guide)

### OPTICAL RESULTS (MEASURED):



LED XB-D  
 FWHM / FWTM 150.0 + 63.0°  
 Efficiency 88 %  
 Peak intensity 2.3 cd/lm  
 LEDs/each optic 1  
 Light colour White  
 Required components:

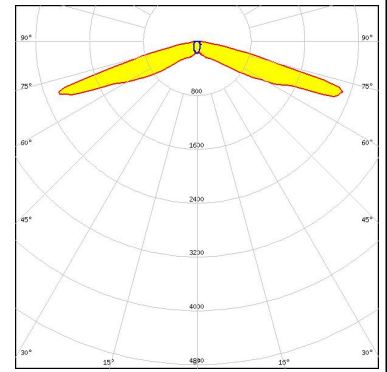

LED XM-L  
 FWHM / FWTM 152.0 + 81.0°  
 Efficiency 91 %  
 Peak intensity 1.2 cd/lm  
 LEDs/each optic 1  
 Light colour White  
 Required components:

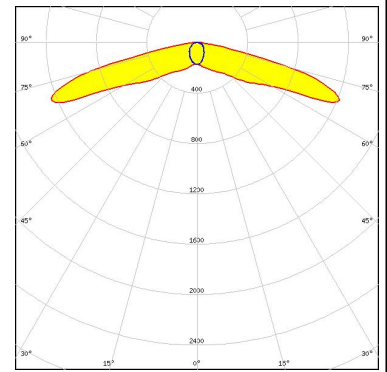

LED XM-L2  
 FWHM / FWTM 167.0 + 71.0°  
 Efficiency 92 %  
 Peak intensity 1.2 cd/lm  
 LEDs/each optic 1  
 Light colour White  
 Required components:

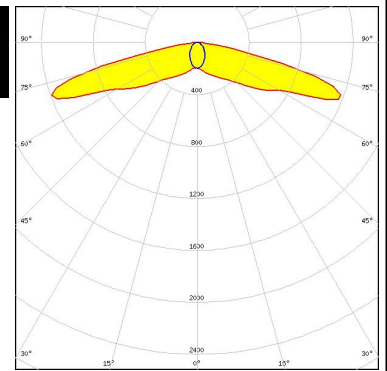

LED XP-E  
 FWHM / FWTM 152.0 + 71.0°  
 Efficiency 93 %  
 Peak intensity 2.8 cd/lm  
 LEDs/each optic 1  
 Light colour White  
 Required components:

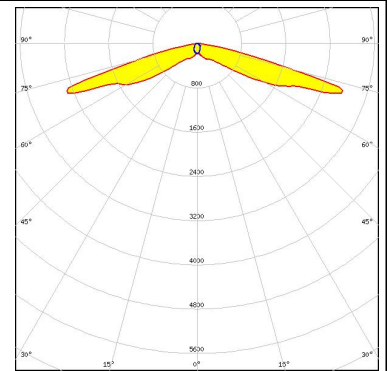

### OPTICAL RESULTS (MEASURED):



LED XP-E2  
 FWHM / FWTM 153.0 + 70.0°  
 Efficiency 93 %  
 Peak intensity 2.9 cd/lm  
 LEDs/each optic 1  
 Light colour White  
 Required components:

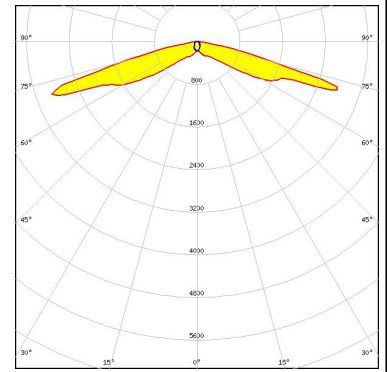

LED XP-G  
 FWHM / FWTM 153.0 + 92.0°  
 Efficiency 88 %  
 Peak intensity 1.9 cd/lm  
 LEDs/each optic 1  
 Light colour White  
 Required components:

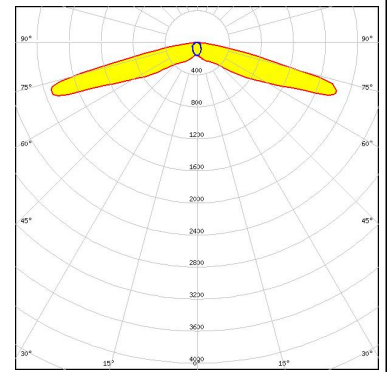

LED XP-G2  
 FWHM / FWTM 151.0 + 75.0°  
 Efficiency 91 %  
 Peak intensity 2 cd/lm  
 LEDs/each optic 1  
 Light colour White  
 Required components:

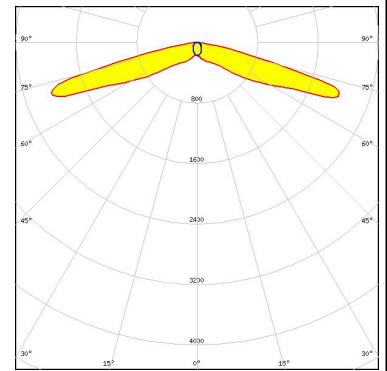

LED XT-E  
 FWHM / FWTM 150.0 + 64.0°  
 Efficiency 88 %  
 Peak intensity 2 cd/lm  
 LEDs/each optic 1  
 Light colour White  
 Required components:

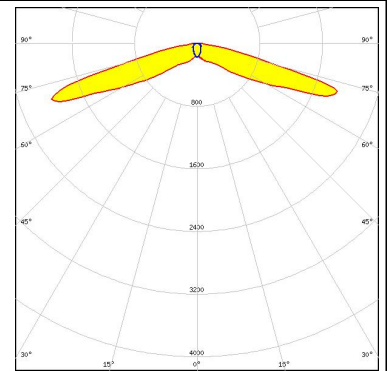

### OPTICAL RESULTS (MEASURED):

#### LUMILEDS

LED LUXEON A  
 FWHM / FWTM 151.0 + 73.0°  
 Efficiency 89 %  
 Peak intensity 1.8 cd/lm  
 LEDs/each optic 1  
 Light colour White  
 Required components:

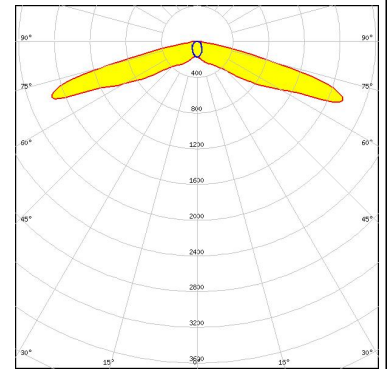

#### LUMILEDS

LED LUXEON R  
 FWHM / FWTM 147.0 + 71.0°  
 Efficiency 88 %  
 Peak intensity 1.9 cd/lm  
 LEDs/each optic 1  
 Light colour White  
 Required components:

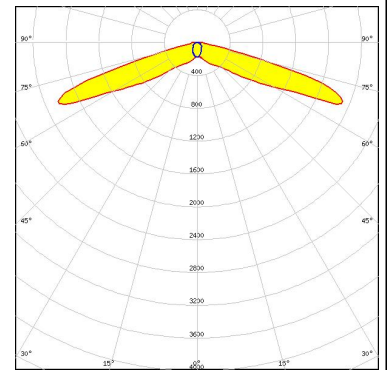

#### LUMILEDS

LED LUXEON Rebel  
 FWHM / FWTM 146.0 + 64.0°  
 Efficiency 88 %  
 Peak intensity 2.9 cd/lm  
 LEDs/each optic 1  
 Light colour White  
 Required components:

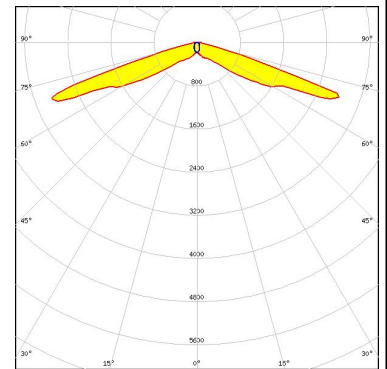

#### LUMILEDS

LED LUXEON Rebel ES  
 FWHM / FWTM 147.0 + 73.0°  
 Efficiency 88 %  
 Peak intensity 1.9 cd/lm  
 LEDs/each optic 1  
 Light colour White  
 Required components:

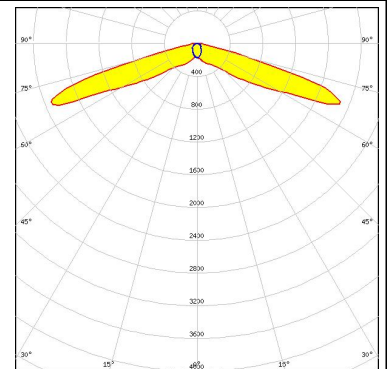

### OPTICAL RESULTS (MEASURED):

#### LUMILEDS

LED LUXEON T  
 FWHM / FWTM 151.0 + 75.0°  
 Efficiency 93 %  
 Peak intensity 1.8 cd/lm  
 LEDs/each optic 1  
 Light colour White  
 Required components:

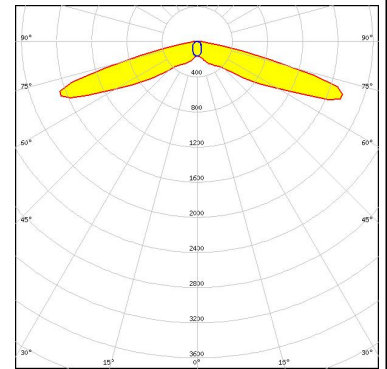

#### LUMILEDS

LED LUXEON TX  
 FWHM / FWTM 151.0 + 71.0°  
 Efficiency 92 %  
 Peak intensity 1.9 cd/lm  
 LEDs/each optic 1  
 Light colour White  
 Required components:

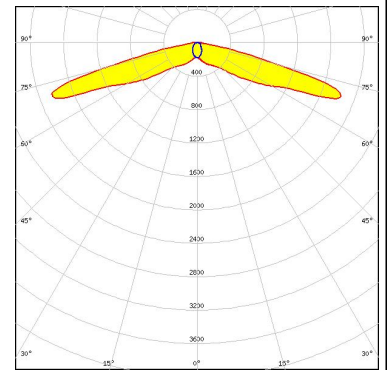

#### NICHIA

LED NCSxx19A  
 FWHM / FWTM 145.0 + 64.0°  
 Efficiency 88 %  
 Peak intensity 2.2 cd/lm  
 LEDs/each optic 1  
 Light colour White  
 Required components:

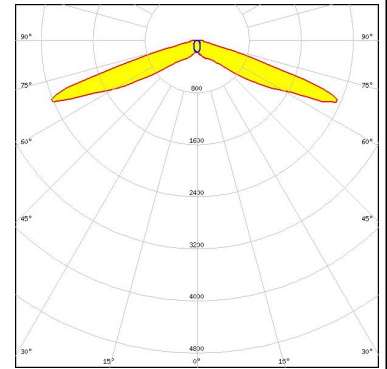

#### NICHIA

LED NS9x383  
 FWHM / FWTM 150.0 + 82.0°  
 Efficiency 89 %  
 Peak intensity 1 cd/lm  
 LEDs/each optic 1  
 Light colour White  
 Required components:

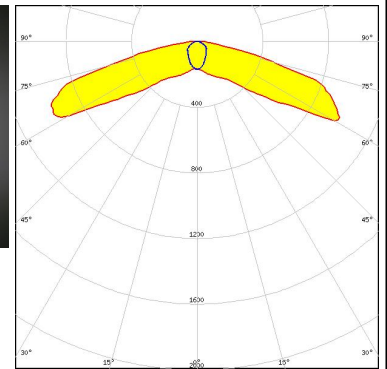
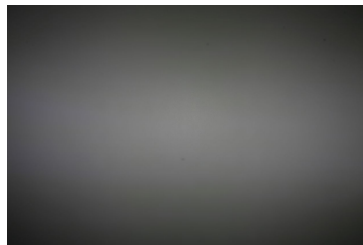

### OPTICAL RESULTS (MEASURED):

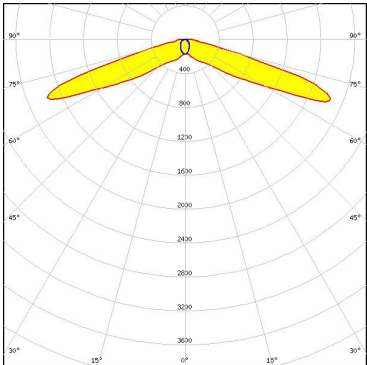
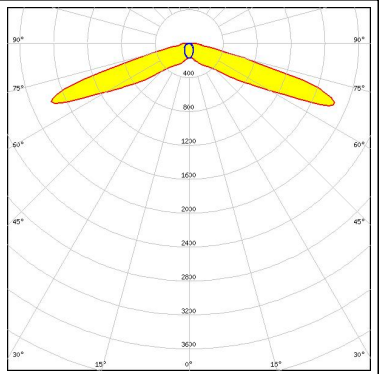
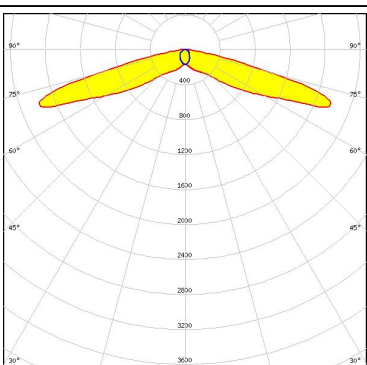
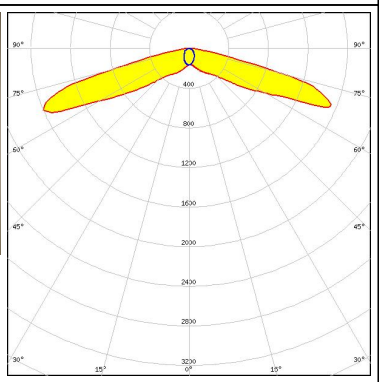
<p><b>NICHIA</b></p> <p>LED NVSxx19A            FWHM / FWTM 147.0 + 70.0°            Efficiency 87 %            Peak intensity 1.9 cd/lm            LEDs/each optic 1            Light colour White            Required components:</p>	
<p><b>NICHIA</b></p> <p>LED NVSxx19B/NVSxx19C            FWHM / FWTM 151.0 + 77.0° / 163.0 + 152.0°            Efficiency 87 %            Peak intensity 1.6 cd/lm            LEDs/each optic 1            Light colour White            Required components:</p>	
<p><b>OSRAM</b> Opto Semiconductors</p> <p>LED OSLON Square CSSRM2/CSSRM3            FWHM / FWTM 152.0 + 76.0° / 163.0 + 158.0°            Efficiency 90 %            Peak intensity 1.8 cd/lm            LEDs/each optic 1            Light colour White            Required components:</p>	
<p><b>OSRAM</b> Opto Semiconductors</p> <p>LED OSLON Square EC            FWHM / FWTM 150.0 + 76.0°            Efficiency 89 %            Peak intensity 1.9 cd/lm            LEDs/each optic 1            Light colour White            Required components:</p>	

### OPTICAL RESULTS (MEASURED):

#### OSRAM

Opto Semiconductors

LED OSLON Square PC  
 FWHM / FWTM 150.0 + 86.0°  
 Efficiency 89 %  
 Peak intensity 2 cd/lm  
 LEDs/each optic 1  
 Light colour White  
 Required components:

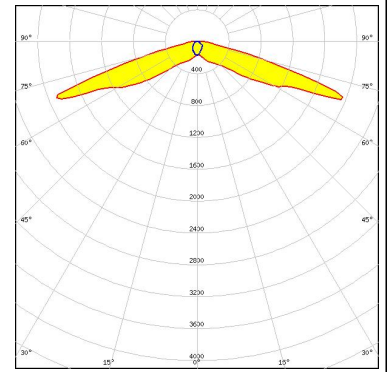

#### OSRAM

Opto Semiconductors

LED OSLON SSL 150  
 FWHM / FWTM 152.0 + 99.0°  
 Efficiency 92 %  
 Peak intensity 2.9 cd/lm  
 LEDs/each optic 1  
 Light colour White  
 Required components:

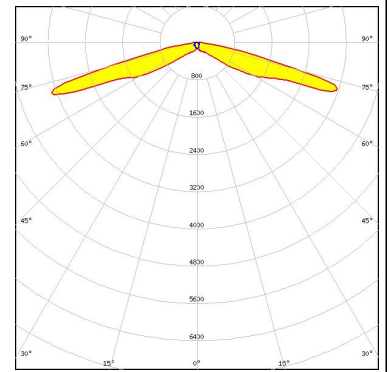

#### OSRAM

Opto Semiconductors

LED OSLON SSL 80  
 FWHM / FWTM 148.0 + 53.0°  
 Efficiency 89 %  
 Peak intensity 2.3 cd/lm  
 LEDs/each optic 1  
 Light colour White  
 Required components:

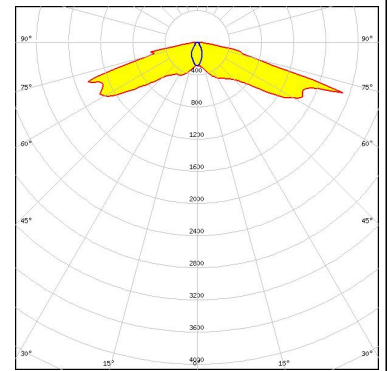



### OPTICAL RESULTS (SIMULATED):



LED XP-G3  
 FWHM / FWTM 157.0 + 79.0° / 171.0 + 182.0°  
 Efficiency 88 %  
 Peak intensity 1.1 cd/lm  
 LEDs/each optic 1  
 Light colour White  
 Required components:

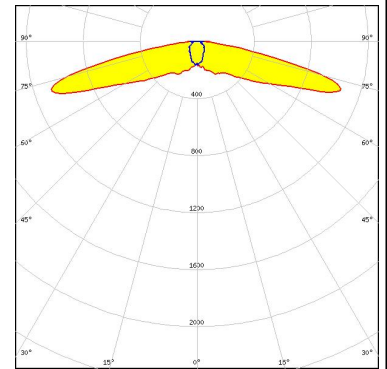

LED XP-L HI  
 FWHM / FWTM 156.0 + 64.0° / 168.0 + 166.0°  
 Efficiency 90 %  
 Peak intensity 1.3 cd/lm  
 LEDs/each optic 1  
 Light colour White  
 Required components:

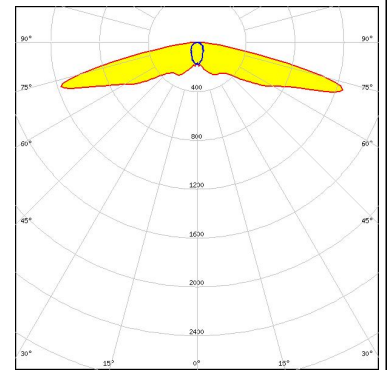

LED XP-P  
 FWHM / FWTM 153.0 + 39.0° / 165.0 + 148.0°  
 Efficiency 91 %  
 Peak intensity 1.6 cd/lm  
 LEDs/each optic 1  
 Light colour White  
 Required components:

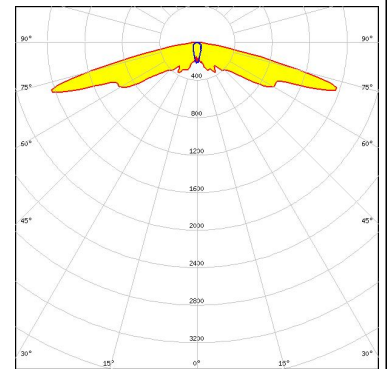

LED LUXEON 5050 Round LES  
 FWHM / FWTM Asymmetric  
 Efficiency 87 %  
 Peak intensity 0.8 cd/lm  
 LEDs/each optic 1  
 Light colour White  
 Required components:

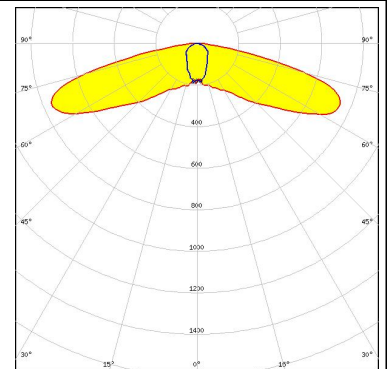

### OPTICAL RESULTS (SIMULATED):

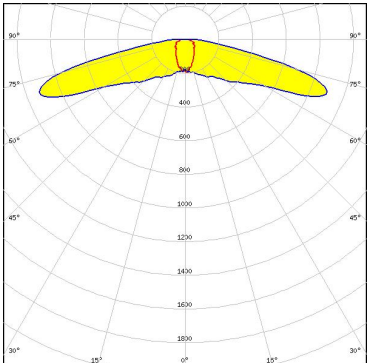
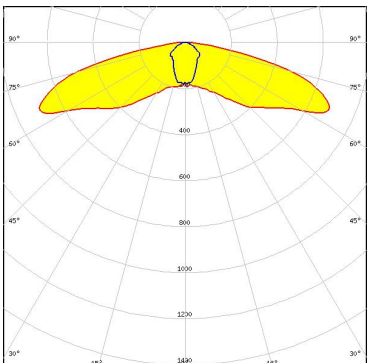
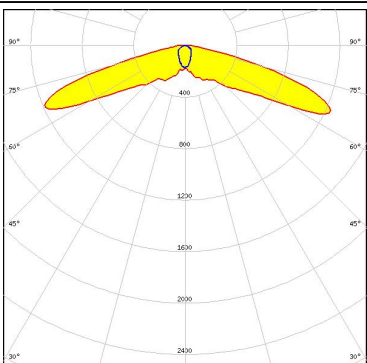
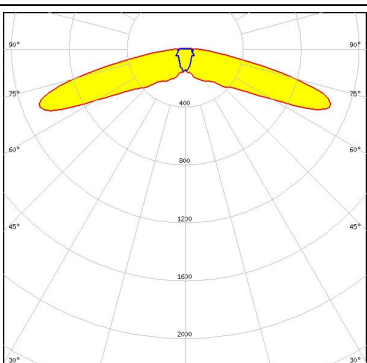
<p><b>LUMILEDS</b></p> <p>LED LUXEON V</p> <p>FWHM / FWTM 64.0 + 156.0° / 176.0 + 175.0°</p> <p>Efficiency 90 %</p> <p>Peak intensity 0.9 cd/lm</p> <p>LEDs/each optic 1</p> <p>Light colour White</p> <p>Required components:</p>	
<p><b>OSRAM</b> Opto Semiconductors</p> <p>LED OSCONIQ S 5050</p> <p>FWHM / FWTM 154.0 + 72.0° / 168.0 + 154.0°</p> <p>Efficiency 87 %</p> <p>Peak intensity 0.7 cd/lm</p> <p>LEDs/each optic 1</p> <p>Light colour White</p> <p>Required components:</p>	
<p><b>SEOUL SEMICONDUCTOR</b></p> <p>LED Z5M4</p> <p>FWHM / FWTM 149.0 + 67.0° / 164.0 + 140.0°</p> <p>Efficiency 89 %</p> <p>Peak intensity 1.2 cd/lm</p> <p>LEDs/each optic 1</p> <p>Light colour White</p> <p>Required components:</p>	
<p><b>SEOUL SEMICONDUCTOR</b></p> <p>LED Z8Y22P</p> <p>FWHM / FWTM 154.6 + 110.7° / 172.0 + 180.0°</p> <p>Efficiency 93 %</p> <p>Peak intensity 1.1 cd/lm</p> <p>LEDs/each optic 1</p> <p>Light colour White</p> <p>Required components:</p>	

### GENERAL INFORMATION:

NOTE: The typical beam angle will be changed by different color, chip size and chip position tolerance. The typical total beam angle is the full angle measured where the luminous intensity is half of the peak value.

### MATERIALS:

As part of our continuous research and improvement processes, and to ensure the best possible quality and availability of our products, LEDiL reserves the right to change material grades without notice.

### PRODUCT DATA USER AGREEMENT AND DISCLAIMER:

The measured data in the provided downloadable LEDiL Product Datasheets and Mechanical 2D-Drawings is rounded and provided as reference for planning. LEDiL Oy's optical specifications have been verified by conducting performance testing of the products in accordance with the company's quality system. The reported data are averaged results of multiple measurements with typical variation. LEDiL Oy reserves the right to without prior notification make changes and improvements to its products.

LEDiL Oy assumes neither warranty, nor guarantee nor any other liability of any kind for the contents and correctness of the provided data. The provided data has been generated with highest diligence but the provided data may in reality not represent the complete possible variation range of all intrinsic parameters. Therefore, in certain cases a deviation from the provided data could occur.

LEDiL Oy reserves the right to undertake technical changes of its products without further notification which could lead to changes in the provided data. LEDiL Oy assumes no liability of any kind for the possible deviation from any provided data or any other damage resulting from the usage of the provided data.

The user agrees to this disclaimer and user agreement with the download or usage of the provided files.

#### LEDiL Oy

Joensuunkatu 13  
FI-24240 SALO  
Finland

#### LEDiL Inc.

228 West Page Street  
Suite D  
Sycamore IL 60178  
USA

#### Ledil Optics Technology (Shenzhen) Co., Ltd.

# 405 , Block B  
Casic Motor Building  
Shenzhen 518057  
P.R.CHINA

#### Local sales and technical support

[www.ledil.com/  
where\\_to\\_buy](http://www.ledil.com/where_to_buy)

#### Shipping locations

Salo, Finland  
Hong Kong, China

#### Distribution Partners

[www.ledil.com/  
where\\_to\\_buy](http://www.ledil.com/where_to_buy)