

EMMA-360

~170° side emitter

SPECIFICATION:

Dimensions	9.9 x 9.9 mm
Height	5.7 mm
Fastening	glue, pin
ROHS compliant	yes ⓘ

MATERIALS:

Component	Type	Material	Colour	Finish
EMMA-360	Single lens	PMMA	clear	

ORDERING INFORMATION:

Component	Qty in box	MOQ	MPQ	Box weight (kg)
C13055_EMMA-360	5000	300	100	1.6
» Box size:				



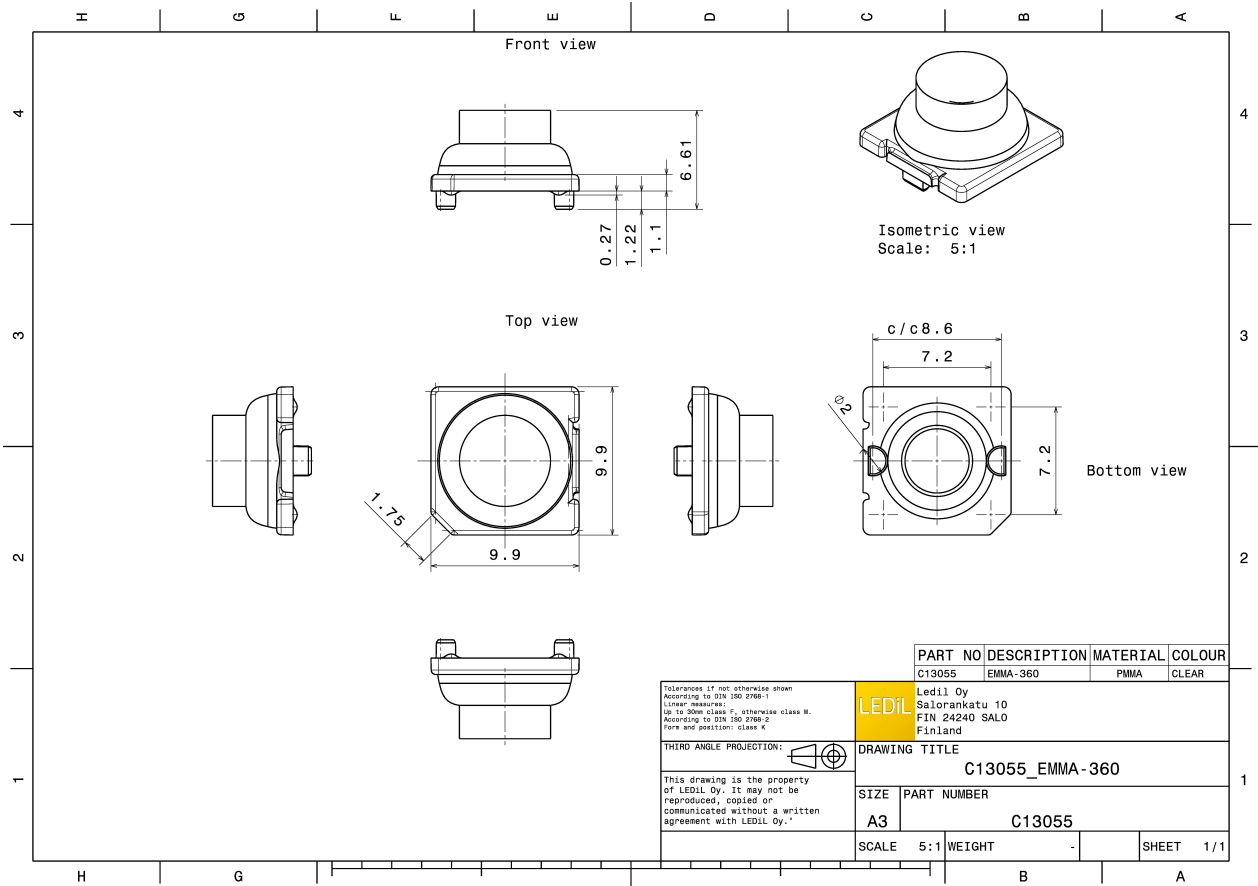

See also our general installation guide: www.ledil.com/installation_guide

OPTICAL RESULTS (MEASURED):

CREE LED

LED XB-D
 FWHM / FWTM 170.0°
 Efficiency 93 %
 Peak intensity 0.4 cd/lm
 LEDs/each optic 1
 Light colour White
 Required components:

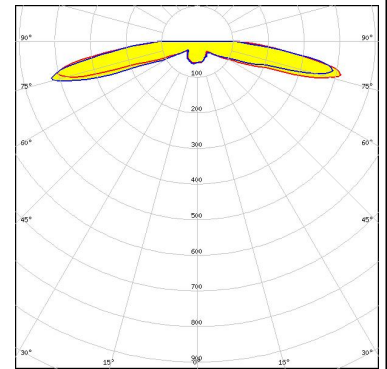

CREE LED

LED XP-E2
 FWHM / FWTM 172.0°
 Efficiency 94 %
 Peak intensity 0.4 cd/lm
 LEDs/each optic 1
 Light colour White
 Required components:

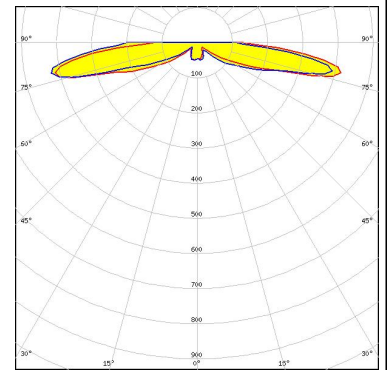

CREE LED

LED XP-G
 FWHM / FWTM 173.0°
 Efficiency 88 %
 Peak intensity 0.4 cd/lm
 LEDs/each optic 1
 Light colour White
 Required components:

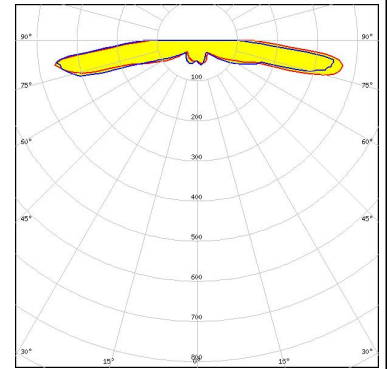

CREE LED

LED XP-G2
 FWHM / FWTM 172.0°
 Efficiency 90 %
 Peak intensity 0.4 cd/lm
 LEDs/each optic 1
 Light colour White
 Required components:

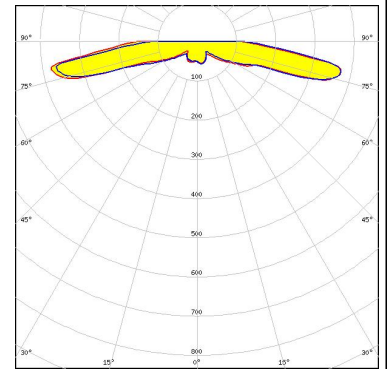

OPTICAL RESULTS (MEASURED):

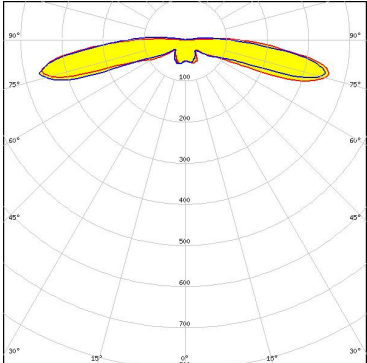
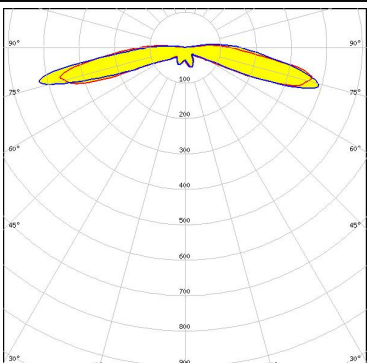
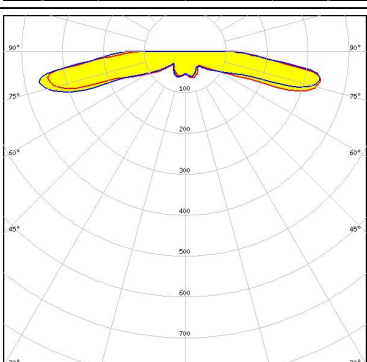
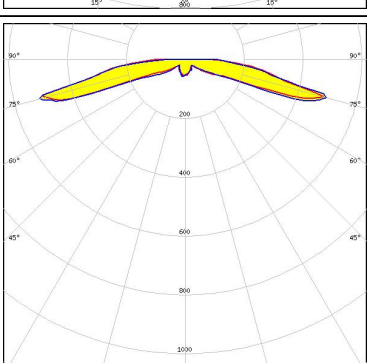
<p>CREE LED</p> <p>LED XT-E FWHM / FWTM 174.0° / 188.0° Efficiency 94 % Peak intensity 0.4 cd/lm LEDs/each optic 1 Light colour White Required components:</p>	
<p>LUMILEDS</p> <p>LED LUXEON 3535 2D FWHM / FWTM 170.0° Efficiency 94 % Peak intensity 0.4 cd/lm LEDs/each optic 1 Light colour White Required components:</p>	
<p>LUMILEDS</p> <p>LED LUXEON A FWHM / FWTM 173.0° Efficiency 92 % Peak intensity 0.4 cd/lm LEDs/each optic 1 Light colour White Required components:</p>	
<p>LUMILEDS</p> <p>LED LUXEON Rebel FWHM / FWTM 165.0° Efficiency 93 % Peak intensity 0.5 cd/lm LEDs/each optic 1 Light colour White Required components:</p>	

OPTICAL RESULTS (MEASURED):

		
LED	NCSxx19A	
FWHM / FWTM	165.0°	
Efficiency	90 %	
Peak intensity	0.4 cd/lm	
LEDs/each optic	1	
Light colour	White	
Required components:		
		
LED	OSLON Square EC	
FWHM / FWTM	170.0°	
Efficiency	92 %	
Peak intensity	0.4 cd/lm	
LEDs/each optic	1	
Light colour	White	
Required components:		

OPTICAL RESULTS (SIMULATED):

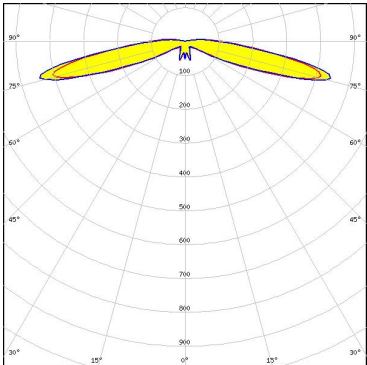
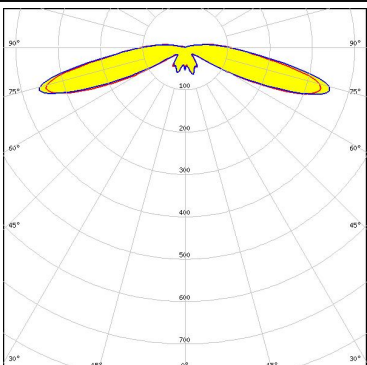
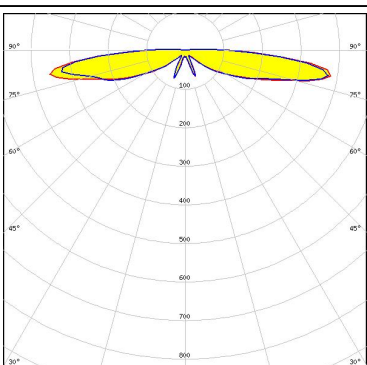
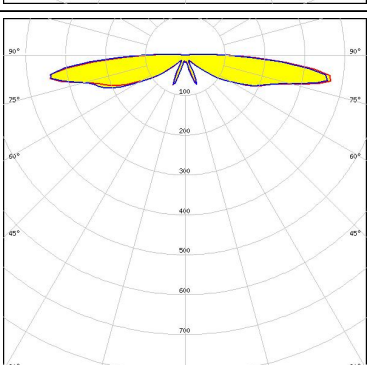
<p>CREE → LED</p> <p>LED J Series 2835 FWHM / FWTM 167.0° / 194.0° Efficiency 96 % Peak intensity 0.4 cd/lm LEDs/each optic 1 Light colour White Required components:</p>	
<p>CREE → LED</p> <p>LED J Series 3030 FWHM / FWTM 167.0° / 198.0° Efficiency 96 % Peak intensity 0.4 cd/lm LEDs/each optic 1 Light colour White Required components:</p>	
<p>CREE → LED</p> <p>LED XE-G FWHM / FWTM 175.0° / 188.0° Efficiency 96 % Peak intensity 0.4 cd/lm LEDs/each optic 1 Light colour White Required components:</p>	
<p>CREE → LED</p> <p>LED XE-G FWHM / FWTM 176.0° / 188.0° Efficiency 96 % Peak intensity 0.4 cd/lm LEDs/each optic 1 Light colour Green Required components:</p>	

OPTICAL RESULTS (SIMULATED):

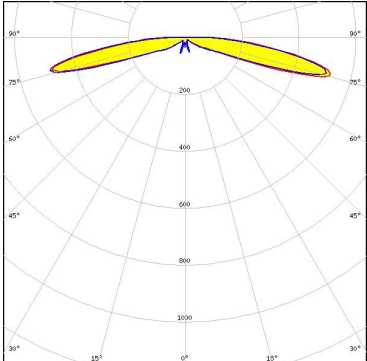
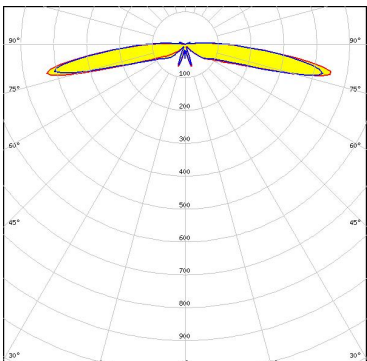
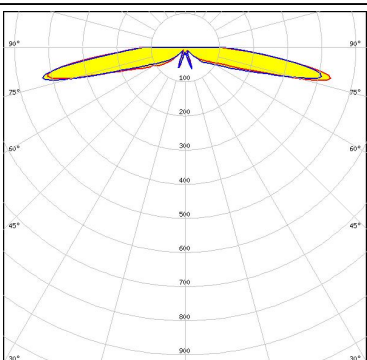
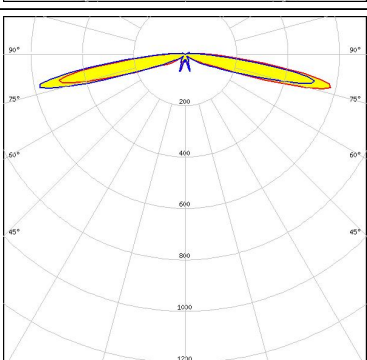
<p>CREE → LED</p> <p>LED: XQ-E HD FWHM / FWTM: 164.0° / 174.0° Efficiency: 92 % Peak intensity: 0.5 cd/lm LEDs/each optic: 1 Light colour: White Required components:</p>	
<p>CREE → LED</p> <p>LED: XQ-E HD FWHM / FWTM: 172.0° / 189.0° Efficiency: 97 % Peak intensity: 0.5 cd/lm LEDs/each optic: 1 Light colour: Red Required components:</p>	
<p>CREE → LED</p> <p>LED: XQ-E HD FWHM / FWTM: 170.0° / 182.0° Efficiency: 89 % Peak intensity: 0.4 cd/lm LEDs/each optic: 1 Light colour: PC Amber Required components:</p>	
<p>CREE → LED</p> <p>LED: XQ-E HI FWHM / FWTM: 166.0° / 181.0° Efficiency: 97 % Peak intensity: 0.6 cd/lm LEDs/each optic: 1 Light colour: Red Required components:</p>	

OPTICAL RESULTS (SIMULATED):

LUMILEDS

LED LUXEON C
 FWHM / FWTM 177.0° / 192.0°
 Efficiency 95 %
 Peak intensity 0.5 cd/lm
 LEDs/each optic 1
 Light colour Red
 Required components:

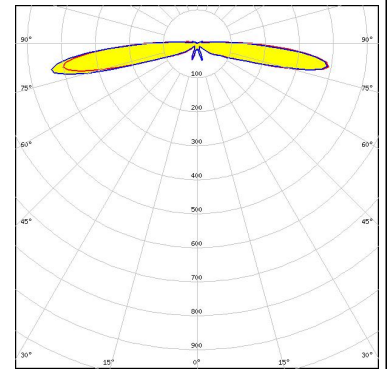

LUMILEDS

LED LUXEON C
 FWHM / FWTM 175.0° / 188.0°
 Efficiency 95 %
 Peak intensity 0.5 cd/lm
 LEDs/each optic 1
 Light colour Green
 Required components:

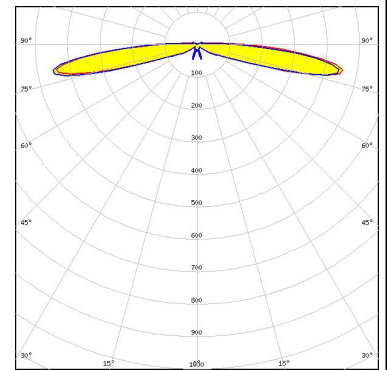

LUMILEDS

LED LUXEON CZ
 FWHM / FWTM 168.0° / 179.0°
 Efficiency 97 %
 Peak intensity 0.6 cd/lm
 LEDs/each optic 1
 Light colour Red
 Required components:

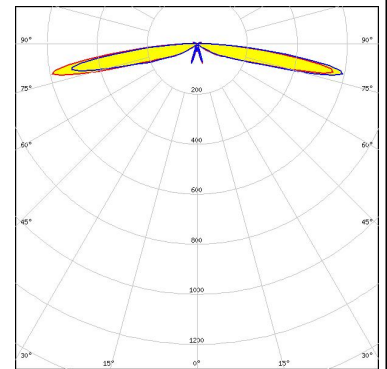

LUMILEDS

LED LUXEON CZ
 FWHM / FWTM 166.0° / 178.0°
 Efficiency 97 %
 Peak intensity 0.7 cd/lm
 LEDs/each optic 1
 Light colour Royal Blue
 Required components:

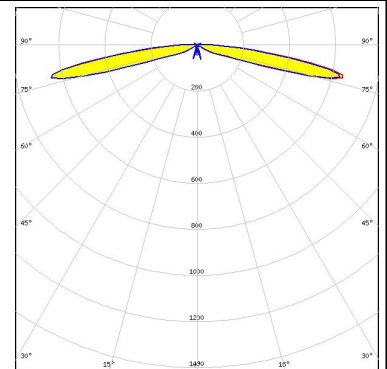

OPTICAL RESULTS (SIMULATED):

LUMILEDS

LED LUXEON CZ
 FWHM / FWTM 166.0° / 178.0°
 Efficiency 97 %
 Peak intensity 0.7 cd/lm
 LEDs/each optic 1
 Light colour Blue
 Required components:

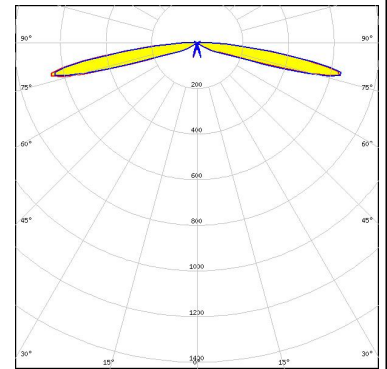

LUMILEDS

LED LUXEON CZ
 FWHM / FWTM 168.0° / 179.0°
 Efficiency 97 %
 Peak intensity 0.6 cd/lm
 LEDs/each optic 1
 Light colour Amber
 Required components:

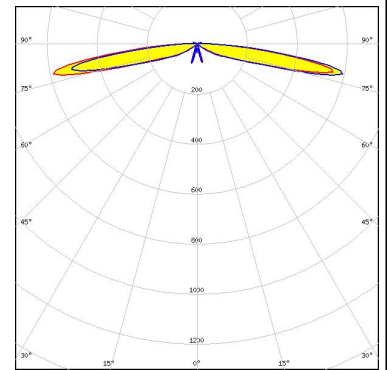

LUMILEDS

LED LUXEON CZ
 FWHM / FWTM 166.0° / 178.0°
 Efficiency 97 %
 Peak intensity 0.7 cd/lm
 LEDs/each optic 1
 Light colour Green
 Required components:

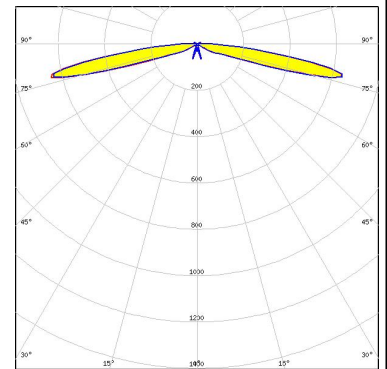

LUMILEDS

LED LUXEON Rubix
 FWHM / FWTM 168.0° / 178.0°
 Efficiency 97 %
 Peak intensity 0.7 cd/lm
 LEDs/each optic 1
 Light colour Green
 Required components:

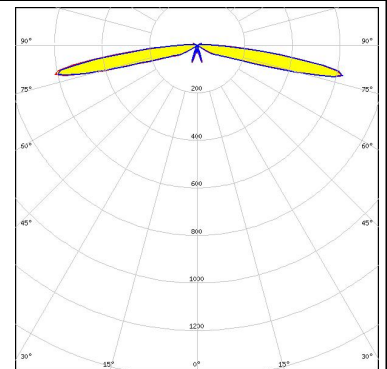

OPTICAL RESULTS (SIMULATED):

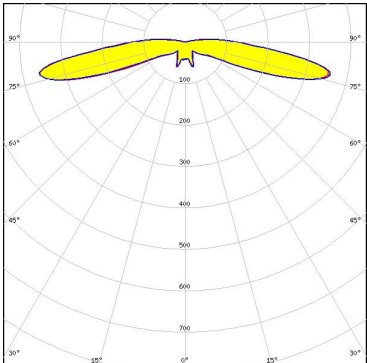
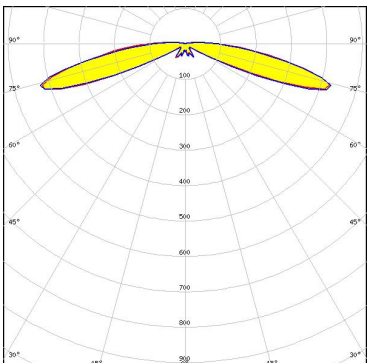
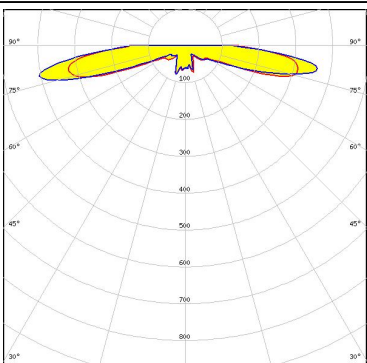
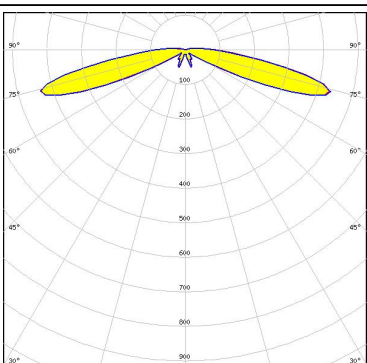
<p>LUMILEDS</p> <p>LED: LUXEON V2 FWHM / FWTM: 172.0° / 196.0° Efficiency: 94 % Peak intensity: 0.4 cd/lm LEDs/each optic: 1 Light colour: White Required components:</p>	
<p>NICHIA</p> <p>LED: NCSxE17A FWHM / FWTM: 166.0° / 189.0° Efficiency: 94 % Peak intensity: 0.4 cd/lm LEDs/each optic: 1 Light colour: Green Required components:</p>	
<p>NICHIA</p> <p>LED: NF2W757G-MT (Tunable White) FWHM / FWTM: 174.0 + 178.0° / 182.0° Efficiency: 90 % Peak intensity: 0.4 cd/lm LEDs/each optic: 1 Light colour: Tunable White Required components:</p>	
<p>NICHIA</p> <p>LED: NVSxE21A FWHM / FWTM: 164.0° / 188.0° Efficiency: 96 % Peak intensity: 0.4 cd/lm LEDs/each optic: 1 Light colour: White Required components:</p>	

OPTICAL RESULTS (SIMULATED):

<p>OSRAM Opto Semiconductors</p> <p>LED OSLO[®] Signal</p> <p>FWHM / FWTM 172.0° / 188.0°</p> <p>Efficiency 97 %</p> <p>Peak intensity 0.5 cd/lm</p> <p>LEDs/each optic 1</p> <p>Light colour Red</p> <p>Required components:</p>	
<p>OSRAM Opto Semiconductors</p> <p>LED OSLO[®] Signal</p> <p>FWHM / FWTM 172.0° / 192.0°</p> <p>Efficiency 97 %</p> <p>Peak intensity 0.4 cd/lm</p> <p>LEDs/each optic 1</p> <p>Light colour White</p> <p>Required components:</p>	
<p>OSRAM Opto Semiconductors</p> <p>LED OSLO[®] SSL 150</p> <p>FWHM / FWTM 172.0° / 188.0°</p> <p>Efficiency 97 %</p> <p>Peak intensity 0.5 cd/lm</p> <p>LEDs/each optic 1</p> <p>Light colour White</p> <p>Required components:</p>	
<p>OSRAM Opto Semiconductors</p> <p>LED OSLO[®] SSL 150</p> <p>FWHM / FWTM 172.0° / 186.0°</p> <p>Efficiency 95 %</p> <p>Peak intensity 0.5 cd/lm</p> <p>LEDs/each optic 1</p> <p>Light colour White</p> <p>Required components:</p>	

OPTICAL RESULTS (SIMULATED):

OSRAM

Opto Semiconductors

LED OSLOM SSL 150
 FWHM / FWTM 171.0° / 187.0°
 Efficiency 97 %
 Peak intensity 0.5 cd/lm
 LEDs/each optic 1
 Light colour Red
 Required components:

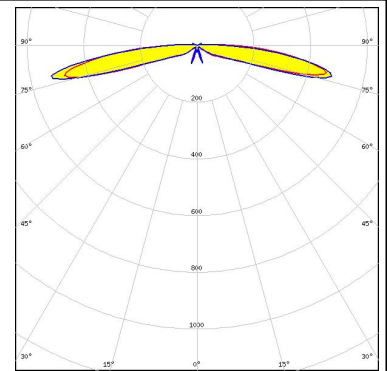

OSRAM

Opto Semiconductors

LED OSLOM SSL 80
 FWHM / FWTM 168.0° / 188.0°
 Efficiency 93 %
 Peak intensity 0.5 cd/lm
 LEDs/each optic 1
 Light colour White
 Required components:

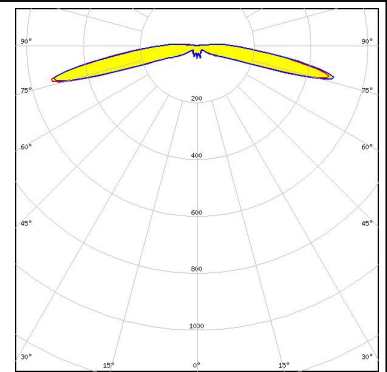

OSRAM

Opto Semiconductors

LED SFH 4716AS
 FWHM / FWTM 164.0° / 180.0°
 Efficiency 96 %
 LEDs/each optic 1
 Light colour IR
 Required components:

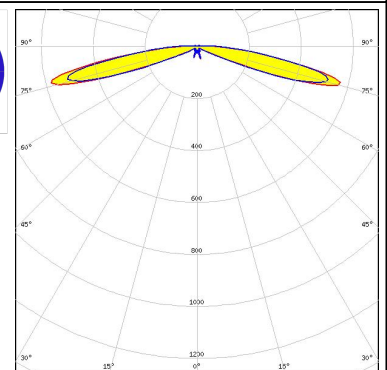
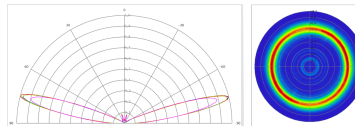

SAMSUNG

LED LM28xB Series
 FWHM / FWTM 169.0° / 199.0°
 Efficiency 97 %
 Peak intensity 0.4 cd/lm
 LEDs/each optic 1
 Light colour White
 Required components:

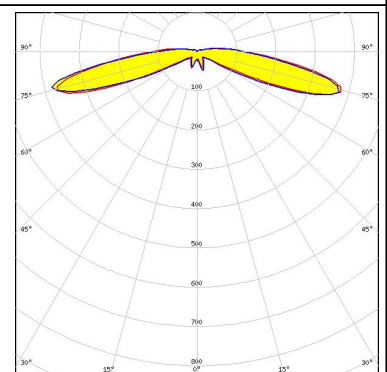

OPTICAL RESULTS (SIMULATED):

<p> SEOUL SEMICONDUCTOR</p> <p>LED MJT 3030 FWHM / FWTM 172.0° / 194.0° Efficiency 95 % Peak intensity 0.5 cd/lm LEDs/each optic 1 Light colour White Required components:</p>	
<p> SEOUL SEMICONDUCTOR</p> <p>LED Z8Y22P FWHM / FWTM 152.0° Efficiency 87 % Peak intensity 0.4 cd/lm LEDs/each optic 1 Light colour White Required components:</p>	

GENERAL INFORMATION:

NOTE: The typical beam angle will be changed by different color, chip size and chip position tolerance. The typical total beam angle is the full angle measured where the luminous intensity is half of the peak value.

MATERIALS:

As part of our continuous research and improvement processes, and to ensure the best possible quality and availability of our products, LEDiL reserves the right to change material grades without notice.

PRODUCT DATA USER AGREEMENT AND DISCLAIMER:

The measured data in the provided downloadable LEDiL Product Datasheets and Mechanical 2D-Drawings is rounded and provided as reference for planning. LEDiL Oy's optical specifications have been verified by conducting performance testing of the products in accordance with the company's quality system. The reported data are averaged results of multiple measurements with typical variation. LEDiL Oy reserves the right to without prior notification make changes and improvements to its products.

LEDiL Oy assumes neither warranty, nor guarantee nor any other liability of any kind for the contents and correctness of the provided data. The provided data has been generated with highest diligence but the provided data may in reality not represent the complete possible variation range of all intrinsic parameters. Therefore, in certain cases a deviation from the provided data could occur.

LEDiL Oy reserves the right to undertake technical changes of its products without further notification which could lead to changes in the provided data. LEDiL Oy assumes no liability of any kind for the possible deviation from any provided data or any other damage resulting from the usage of the provided data.

The user agrees to this disclaimer and user agreement with the download or usage of the provided files.

LEDiL Oy

Joensuunkatu 13
FI-24240 SALO
Finland

LEDiL Inc.

228 West Page Street
Suite D
Sycamore IL 60178
USA

Ledil Optics Technology (Shenzhen) Co., Ltd.

405 , Block B
Casic Motor Building
Shenzhen 518057
P.R.CHINA

Local sales and technical support

[www.ledil.com/
where_to_buy](http://www.ledil.com/where_to_buy)

Shipping locations

Salo, Finland
Hong Kong, China

Distribution Partners

[www.ledil.com/
where_to_buy](http://www.ledil.com/where_to_buy)