

## LENINA-XW

White version with ~75° wide beam

### SPECIFICATION:

Dimensions	Ø 74.0 mm
Height	40 mm
Fastening	socket
ROHS compliant	yes ⓘ

### MATERIALS:

Component	Type	Material
LENINA-XW	Reflector	HRPC

### ORDERING INFORMATION:

#### Component

C12958\_LENINA-XW

» Box size: 476 x 273 x 197 mm







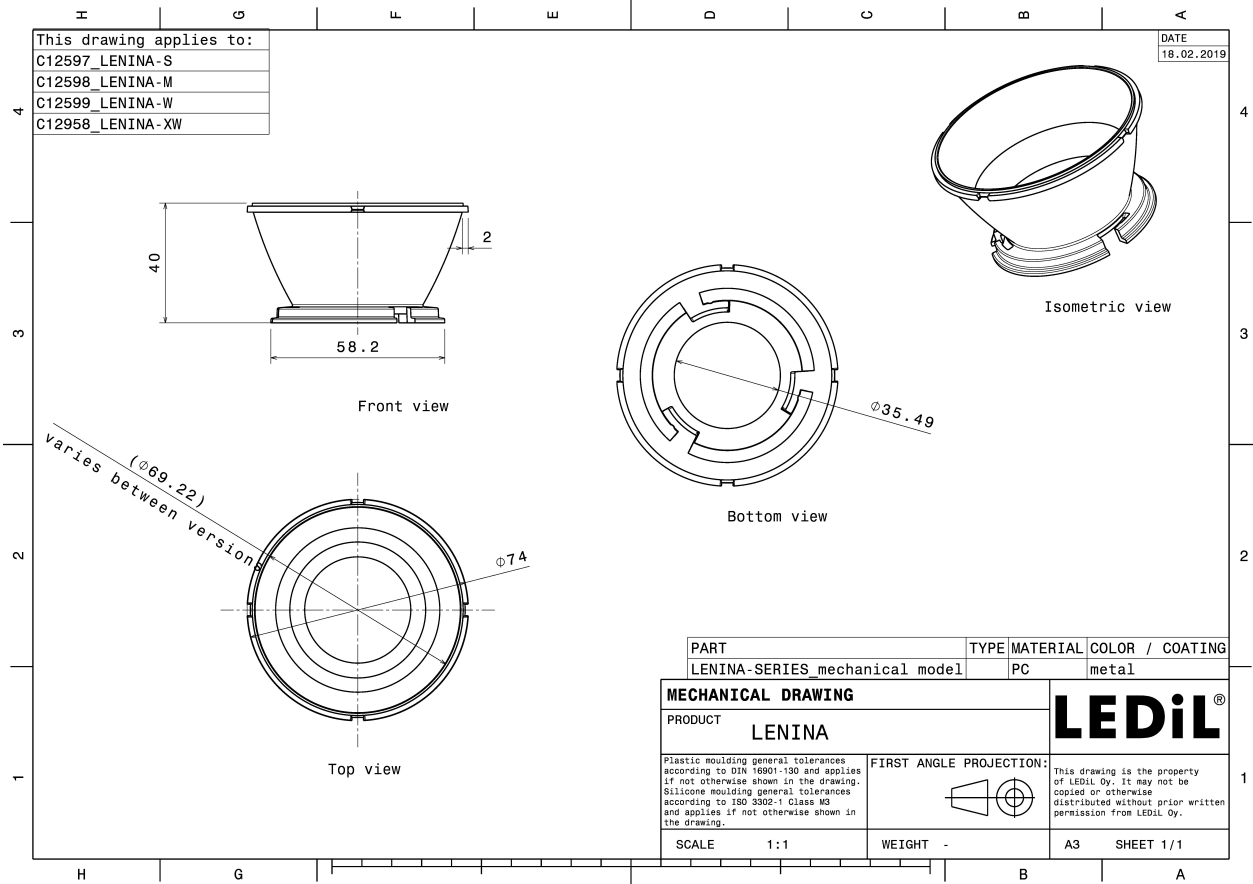

Colour	Finish	Coating
white		

Qty in box	MOQ	MPQ	Box weight (kg)
60	120	60	2.0

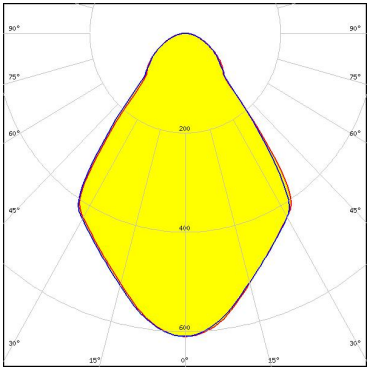

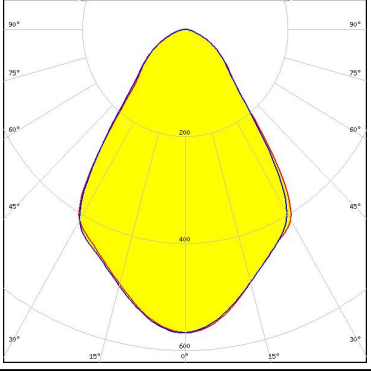

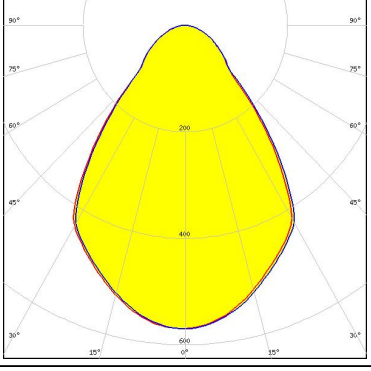

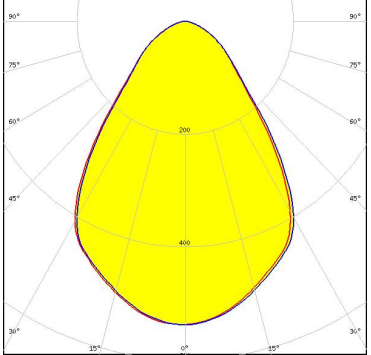

See also our general installation guide: [www.ledil.com/installation\\_guide](http://www.ledil.com/installation_guide)

#### OPTICAL RESULTS (MEASURED):

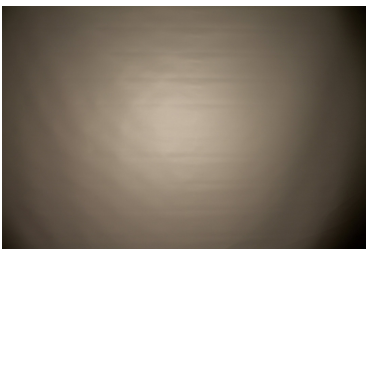
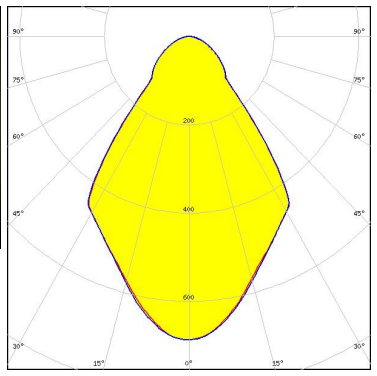

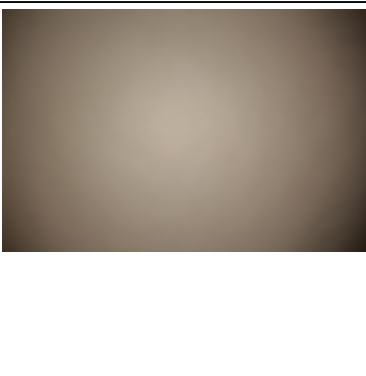
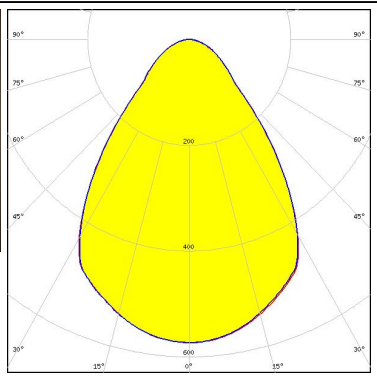
<p></p> <p>LED BXRA ES Rectangle</p> <p>FWHM / FWTM 74.0° / 124.0°</p> <p>Efficiency 89 %</p> <p>Peak intensity 0.6 cd/lm</p> <p>LEDs/each optic 1</p> <p>Light colour White</p> <p>Required components: C12153_LENASTD-BASE-BXRA</p>	
<p></p> <p>LED BXRA ES Rectangle</p> <p>FWHM / FWTM 73.0° / 125.0°</p> <p>Efficiency 84 %</p> <p>Peak intensity 0.6 cd/lm</p> <p>LEDs/each optic 1</p> <p>Light colour White</p> <p>Required components: C12153_LENASTD-BASE-BXRA C12606_LENINA-DL</p>	
<p></p> <p>LED BXRA RS</p> <p>FWHM / FWTM 76.0° / 128.0°</p> <p>Efficiency 91 %</p> <p>Peak intensity 0.6 cd/lm</p> <p>LEDs/each optic 1</p> <p>Light colour White</p> <p>Required components: C12229_LENASTD-BASE-RS</p>	
<p></p> <p>LED BXRA RS</p> <p>FWHM / FWTM 87.0° / 128.0°</p> <p>Efficiency 87 %</p> <p>Peak intensity 0.5 cd/lm</p> <p>LEDs/each optic 1</p> <p>Light colour White</p> <p>Required components: C12229_LENASTD-BASE-RS C12606_LENINA-DL</p>	

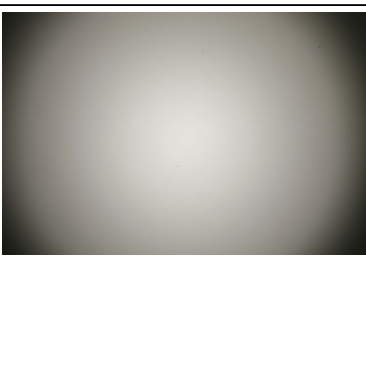
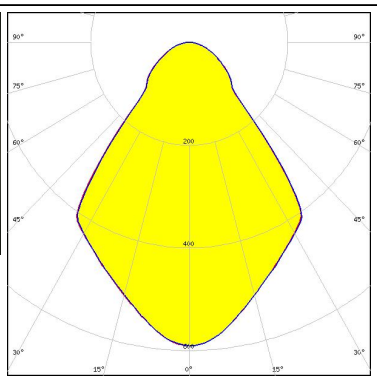
#### OPTICAL RESULTS (MEASURED):

<p></p> <p>LED V10 Gen6            FWHM / FWTM 69.0° / 124.0°            Efficiency 86 %            Peak intensity 0.7 cd/lm            LEDs/each optic 1            Light colour White</p> <p>Required components:            C13186_LENINA-STD-BASE-CXA15            C12606_LENINA-DL</p>		
<p></p> <p>LED V4 HD Gen 7            FWHM / FWTM 71.0° / 120.0°            Efficiency 93 %            Peak intensity 0.7 cd/lm            LEDs/each optic 1            Light colour White</p> <p>Required components:            C14146_LENINA-STD-BASE-CXA18</p>		
<p></p> <p>LED Vero SE 29            FWHM / FWTM 76.0° / 127.0°            Efficiency 93 %            Peak intensity 0.6 cd/lm            LEDs/each optic 1            Light colour White</p> <p>Required components:            C15083_LENINA-STD-BASE-VERO29</p>		
<p></p> <p>LED VERO13            FWHM / FWTM 76.0° / 128.0°            Efficiency 91 %            Peak intensity 0.6 cd/lm            LEDs/each optic 1            Light colour White</p> <p>Required components:            C13868_LENINA-STD-BASE-VERO13-18</p>		

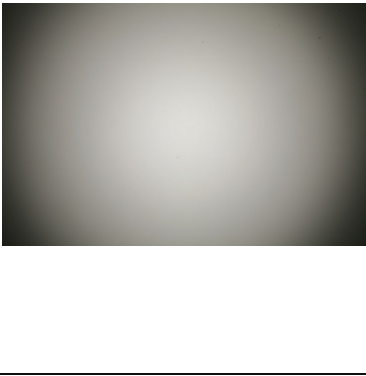
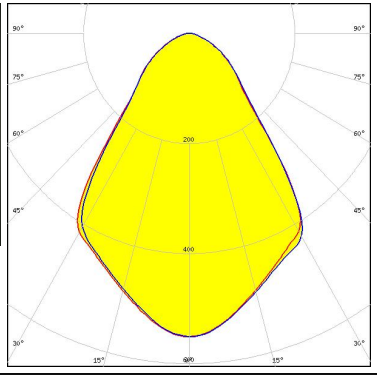
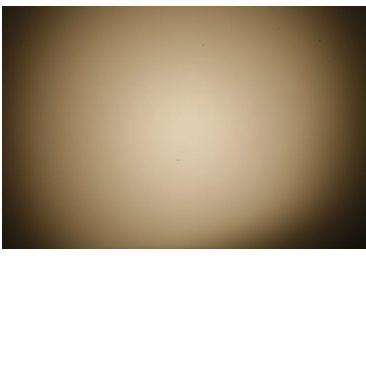
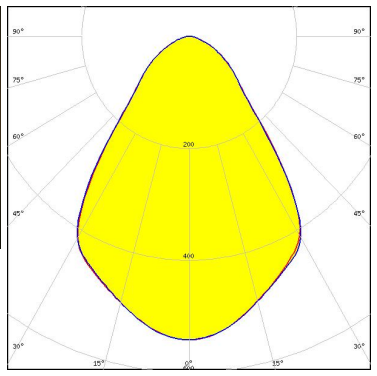

#### OPTICAL RESULTS (MEASURED):

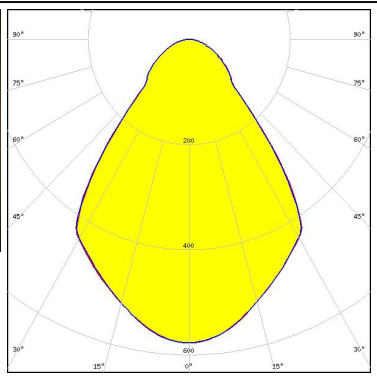
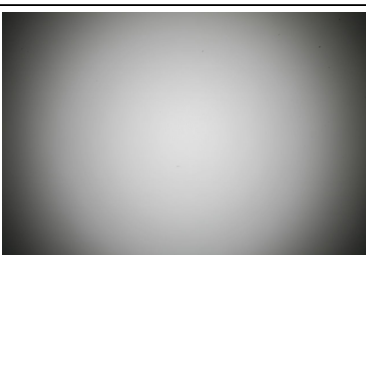
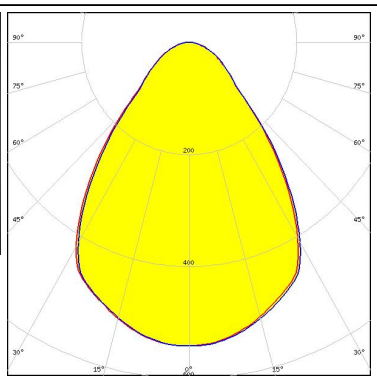
<p>bridgelux.</p> <p>LED VERO13            FWHM / FWTM 75.0° / 127.0°            Efficiency 87 %            Peak intensity 0.6 cd/lm            LEDs/each optic 1            Light colour White</p> <p>Required components:            C13868_LENINA-STD-BASE-VERO13-18            C12606_LENINA-DL</p>		
<p>bridgelux.</p> <p>LED VERO18            FWHM / FWTM 75.0° / 128.0°            Efficiency 87 %            Peak intensity 0.5 cd/lm            LEDs/each optic 1            Light colour White</p> <p>Required components:            C13868_LENINA-STD-BASE-VERO13-18            C12606_LENINA-DL</p>		
<p>bridgelux.</p> <p>LED VERO18            FWHM / FWTM 76.0° / 128.0°            Efficiency 91 %            Peak intensity 0.6 cd/lm            LEDs/each optic 1            Light colour White</p> <p>Required components:            C13868_LENINA-STD-BASE-VERO13-18</p>		
<p>bridgelux.</p> <p>LED VERO29            FWHM / FWTM 77.0° / 130.0°            Efficiency 91 %            Peak intensity 0.5 cd/lm            LEDs/each optic 1            Light colour White</p> <p>Required components:            C13867_LENINA-STD-BASE-VERO29</p>		

#### OPTICAL RESULTS (MEASURED):

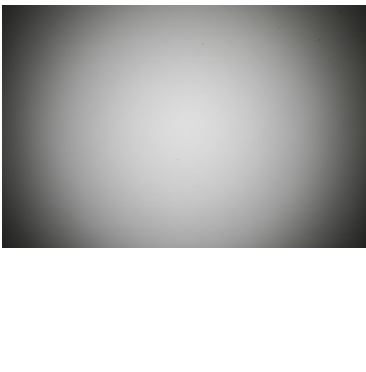
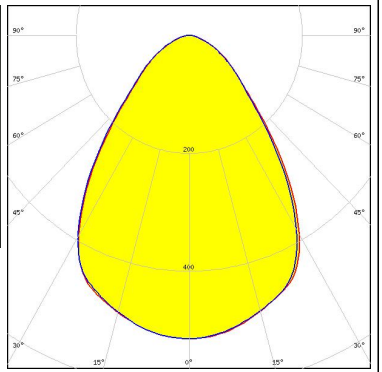
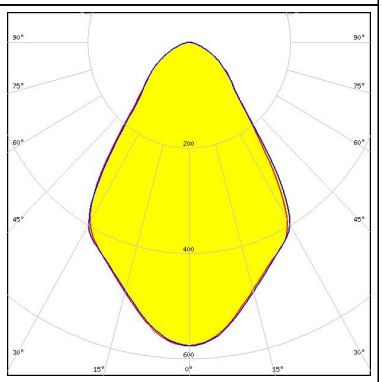
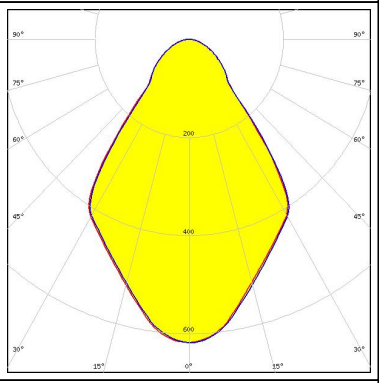
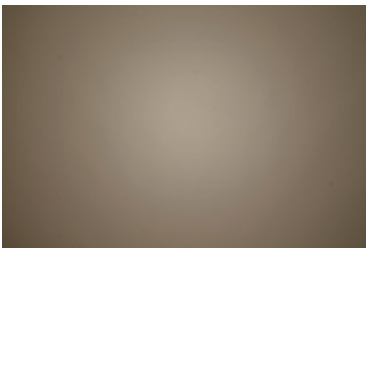
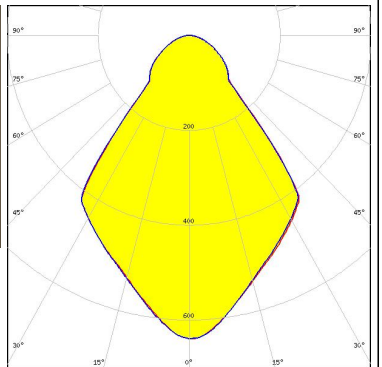
<p></p> <p>LED VERO29            FWHM / FWTM 77.0° / 129.0°            Efficiency 87 %            Peak intensity 0.5 cd/lm            LEDs/each optic 1            Light colour White</p> <p>Required components:            C13867_LENINA-STD-BASE-VERO29            C12606_LENINA-DL</p>		
<p><b>CITIZEN</b></p> <p>LED CL-L340            FWHM / FWTM 71.0° / 123.5°            Efficiency 82 %            Peak intensity 0.6 cd/lm            LEDs/each optic 1            Light colour White</p> <p>Required components:            C11995_LENINA-STD-BASE-CL340            C12606_LENINA-DL</p>		
<p><b>CITIZEN</b></p> <p>LED CL-L340            FWHM / FWTM 72.0° / 122.0°            Efficiency 86 %            Peak intensity 0.6 cd/lm            LEDs/each optic 1            Light colour White</p> <p>Required components:            C11995_LENINA-STD-BASE-CL340</p>		
<p><b>CITIZEN</b></p> <p>LED CLL02x/CLU02x (LES10)            FWHM / FWTM 75.0° / 125.0°            Efficiency 93 %            Peak intensity 0.6 cd/lm            LEDs/each optic 1            Light colour White</p> <p>Required components:            C13868_LENINA-STD-BASE-VERO13-18            Bender Wirth: 434 Typ L1</p>		

#### OPTICAL RESULTS (MEASURED):

#### CITIZEN

LED CLL02x/CLU02x (LES10)  
 FWHM / FWTM 73.0° / 125.0°  
 Efficiency 89 %  
 Peak intensity 0.6 cd/lm  
 LEDs/each optic 1  
 Light colour White  
 Required components:  
 C13868\_LENINA-STD-BASE-VERO13-18  
 C12606\_LENINA-DL  
 Bender Wirth: 434 Typ L1

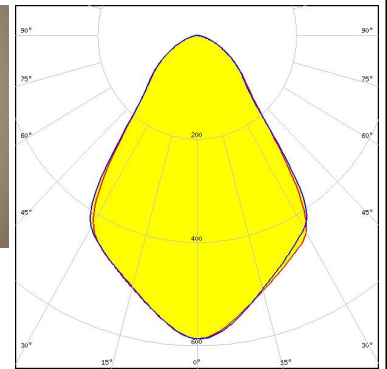
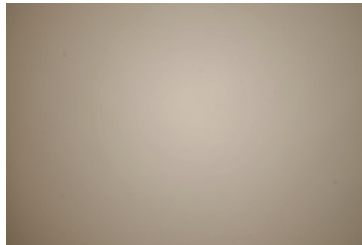

#### CITIZEN

LED CLL03x/CLU03x  
 FWHM / FWTM 74.0° / 125.0°  
 Efficiency 89 %  
 Peak intensity 0.6 cd/lm  
 LEDs/each optic 1  
 Light colour White  
 Required components:  
 C13868\_LENINA-STD-BASE-VERO13-18  
 C12606\_LENINA-DL  
 Bender Wirth: 433 Typ L1

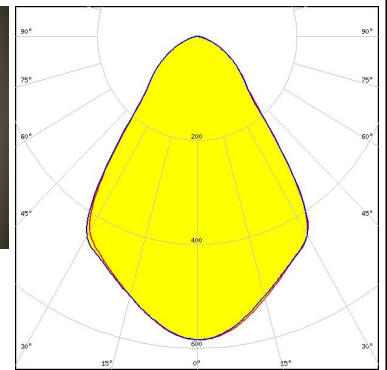
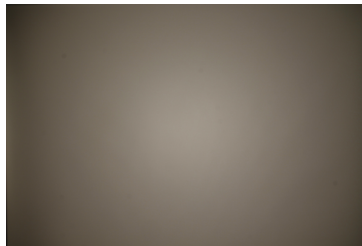

#### CITIZEN

LED CLL03x/CLU03x  
 FWHM / FWTM 74.0° / 124.0°  
 Efficiency 93 %  
 Peak intensity 0.6 cd/lm  
 LEDs/each optic 1  
 Light colour White  
 Required components:  
 C12691\_LENINA-STD-BASE-CLL030

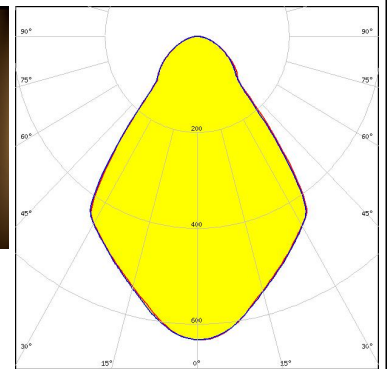

#### CITIZEN

LED CLL03x/CLU03x  
 FWHM / FWTM 75.0° / 126.0°  
 Efficiency 94 %  
 Peak intensity 0.6 cd/lm  
 LEDs/each optic 1  
 Light colour White  
 Required components:  
 C13868\_LENINA-STD-BASE-VERO13-18  
 Bender Wirth: 433 Typ L1

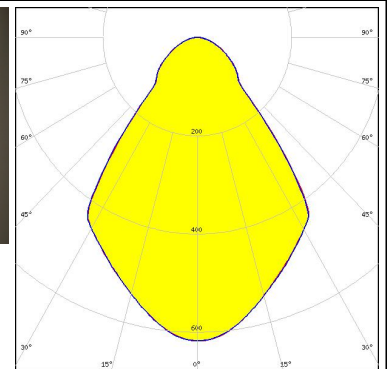
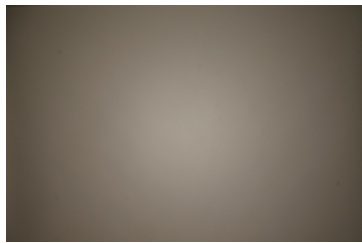

#### OPTICAL RESULTS (MEASURED):

#### CITIZEN

LED CLL03x/CLU03x  
 FWHM / FWTM 72.0° / 125.0°  
 Efficiency 88 %  
 Peak intensity 0.6 cd/lm  
 LEDs/each optic 1  
 Light colour White  
 Required components:  
 C12691\_LENINA-STD-BASE-CLL030  
 C12606\_LENINA-DL

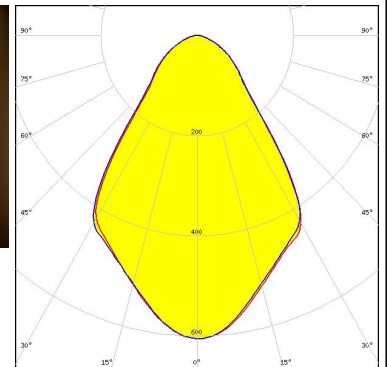
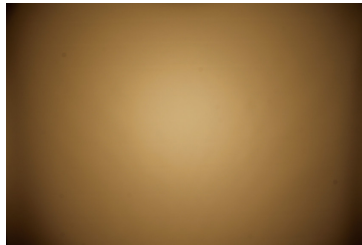

#### CITIZEN

LED CLL04x/CLU04x  
 FWHM / FWTM 71.0° / 124.0°  
 Efficiency 84 %  
 Peak intensity 0.6 cd/lm  
 LEDs/each optic 1  
 Light colour White  
 Required components:  
 C12692\_LENINA-STD-BASE-CLL040  
 C12606\_LENINA-DL

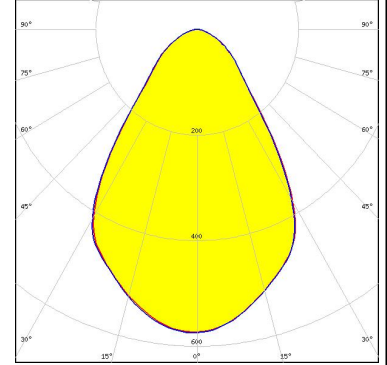

#### CITIZEN

LED CLL04x/CLU04x  
 FWHM / FWTM 74.0° / 126.0°  
 Efficiency 84 %  
 Peak intensity 0.5 cd/lm  
 LEDs/each optic 1  
 Light colour White  
 Required components:  
 A.A.G. STUCCHI: 8102-G2 + S-8000-12

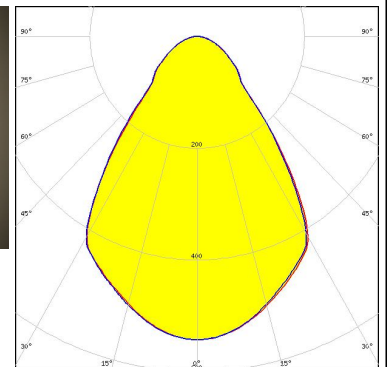
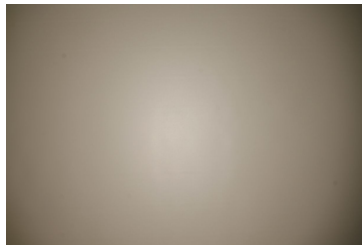

#### CITIZEN

LED CLL04x/CLU04x  
 FWHM / FWTM 75.0° / 127.0°  
 Efficiency 89 %  
 Peak intensity 0.5 cd/lm  
 LEDs/each optic 1  
 Light colour White  
 Required components:  
 C13867\_LENINA-STD-BASE-VERO29  
 C12606\_LENINA-DL  
 Bender Wirth: 431 Typ L3

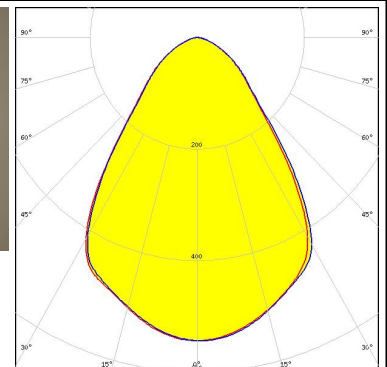
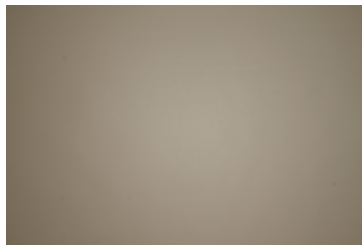

#### OPTICAL RESULTS (MEASURED):

#### CITIZEN

LED CLL04x/CLU04x  
 FWHM / FWTM 73.0° / 126.0°  
 Efficiency 81 %  
 Peak intensity 0.5 cd/lm  
 LEDs/each optic 1  
 Light colour White  
 Required components:  
 C12606\_LENINA-DL  
 A.A.G. STUCCHI: 8102-G2 + S-8000-12

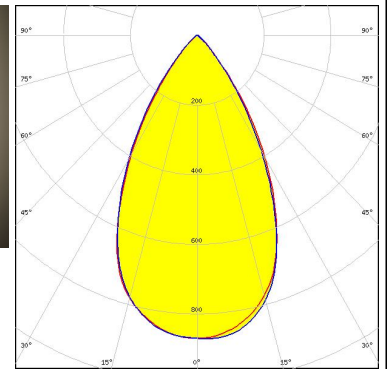

#### CITIZEN

LED CLL04x/CLU04x  
 FWHM / FWTM 75.0° / 127.0°  
 Efficiency 93 %  
 Peak intensity 0.6 cd/lm  
 LEDs/each optic 1  
 Light colour White  
 Required components:  
 C13867\_LENINA-STD-BASE-VERO29  
 Bender Wirth: 431 Typ L3

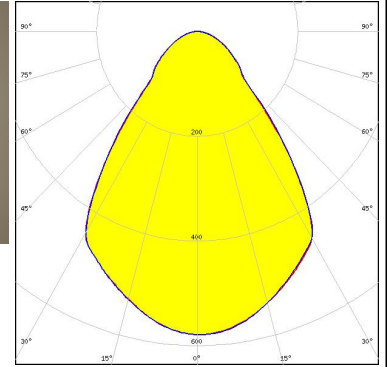

#### CITIZEN

LED CLL04x/CLU04x  
 FWHM / FWTM 72.0° / 124.0°  
 Efficiency 91 %  
 Peak intensity 0.6 cd/lm  
 LEDs/each optic 1  
 Light colour White  
 Required components:  
 IDEAL: 50-2204CT + 50-2100LN

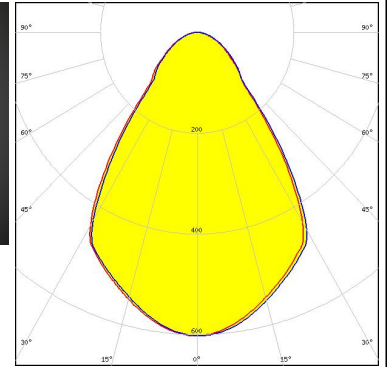
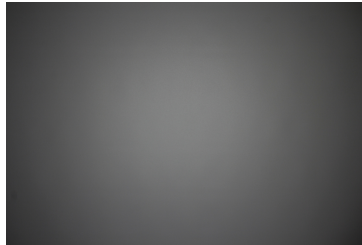

#### CITIZEN

LED CLL04x/CLU04x  
 FWHM / FWTM 71.0° / 124.0°  
 Efficiency 88 %  
 Peak intensity 0.6 cd/lm  
 LEDs/each optic 1  
 Light colour White  
 Required components:  
 C12606\_LENINA-DL  
 IDEAL: 50-2204CT + 50-2100LN

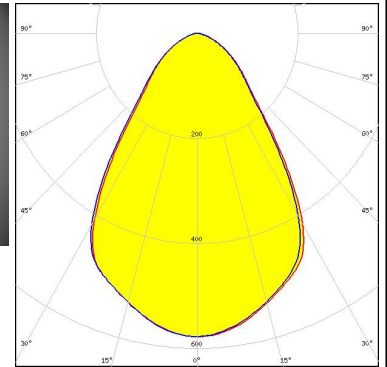
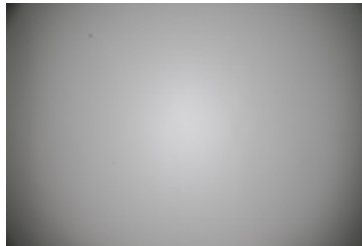



#### OPTICAL RESULTS (MEASURED):

#### CITIZEN

LED CLL04x/CLU04x  
 FWHM / FWTM 71.0° / 122.0°  
 Efficiency 89 %  
 Peak intensity 0.6 cd/lm  
 LEDs/each optic 1  
 Light colour White  
 Required components:  
 C12692\_LENINA-STD-BASE-CLL040

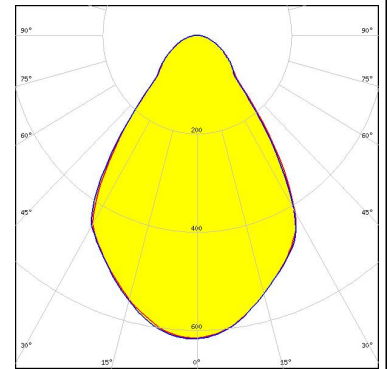

#### CITIZEN

LED CLU700/701/702/703  
 FWHM / FWTM 73.0° / 124.0°  
 Efficiency 89 %  
 Peak intensity 0.6 cd/lm  
 LEDs/each optic 1  
 Light colour White  
 Required components:  
 C13868\_LENINA-STD-BASE-VERO13-18  
 C12606\_LENINA-DL  
 Bender Wirth: 434 Typ L1

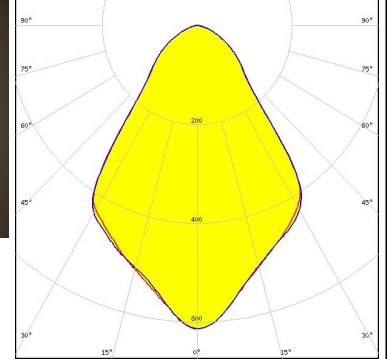
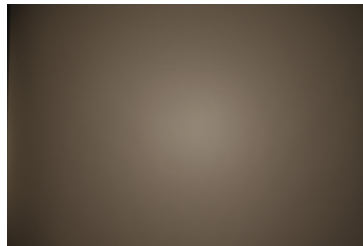

#### CITIZEN

LED CLU700/701/702/703  
 FWHM / FWTM 75.0° / 122.0°  
 Efficiency 93 %  
 Peak intensity 0.7 cd/lm  
 LEDs/each optic 1  
 Light colour White  
 Required components:  
 C13868\_LENINA-STD-BASE-VERO13-18  
 Bender Wirth: 434 Typ L1

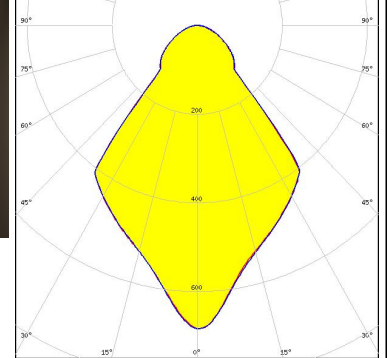
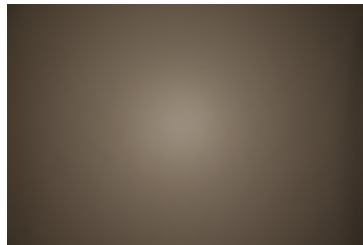

#### CITIZEN

LED CLU710/711  
 FWHM / FWTM 75.0° / 127.0°  
 Efficiency 94 %  
 Peak intensity 0.6 cd/lm  
 LEDs/each optic 1  
 Light colour White  
 Required components:  
 C12691\_LENINA-STD-BASE-CLL030

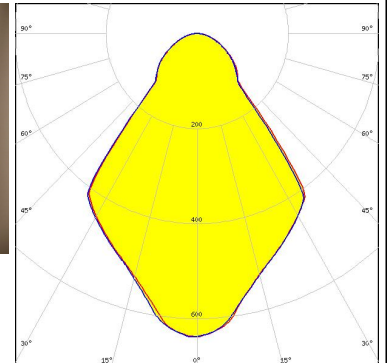
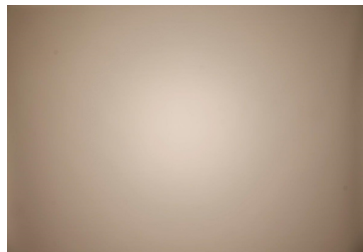

#### OPTICAL RESULTS (MEASURED):

#### CITIZEN

LED CLU710/711  
FWHM / FWTM 73.0° / 127.0°  
Efficiency 90 %  
Peak intensity 0.6 cd/lm  
LEDs/each optic 1  
Light colour White  
Required components:  
C12691\_LENINA-STD-BASE-CLL030  
C12606\_LENINA-DL

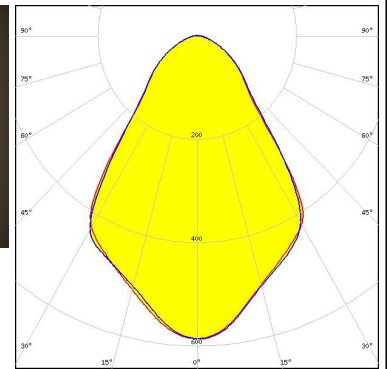
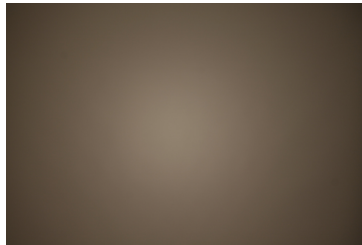

#### CITIZEN

LED CLU720/721/723  
FWHM / FWTM 73.0° / 127.0°  
Efficiency 85 %  
Peak intensity 0.6 cd/lm  
LEDs/each optic 1  
Light colour White  
Required components:  
C12691\_LENINA-STD-BASE-CLL030  
C12606\_LENINA-DL

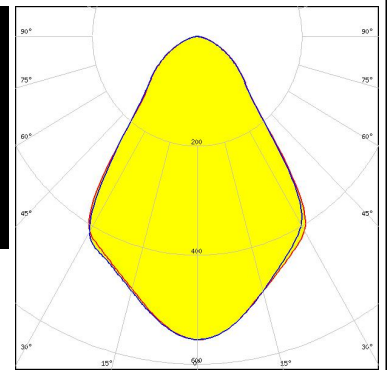
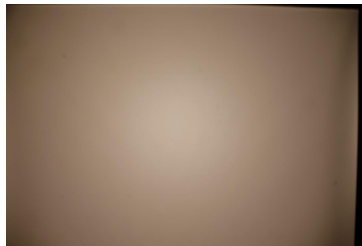

#### CITIZEN

LED CLU720/721/723  
FWHM / FWTM 74.0° / 127.0°  
Efficiency 89 %  
Peak intensity 0.6 cd/lm  
LEDs/each optic 1  
Light colour White  
Required components:  
C12691\_LENINA-STD-BASE-CLL030

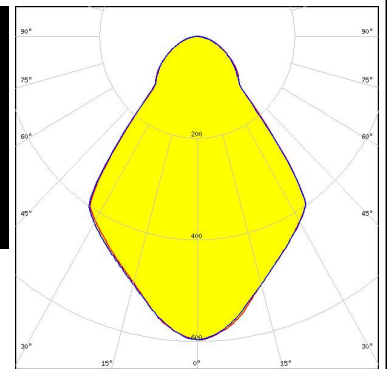
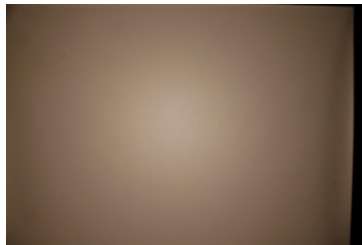

#### CITIZEN

LED CLU730/731/733  
FWHM / FWTM 71.0° / 125.0°  
Efficiency 84 %  
Peak intensity 0.6 cd/lm  
LEDs/each optic 1  
Light colour White  
Required components:  
C12692\_LENINA-STD-BASE-CLL040  
C12606\_LENINA-DL

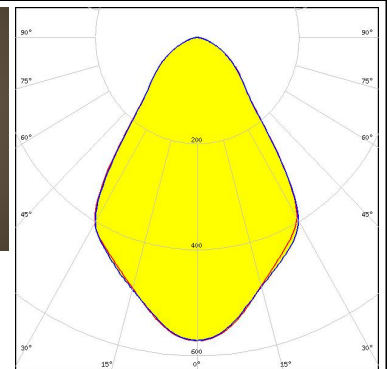
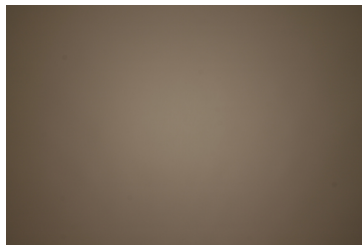



#### OPTICAL RESULTS (MEASURED):

### CITIZEN

LED CLU730/731/733  
 FWHM / FWTM 72.0° / 124.0°  
 Efficiency 94 %  
 Peak intensity 0.7 cd/lm  
 LEDs/each optic 1  
 Light colour White  
 Required components:  
 C12692\_LENINA-STD-BASE-CLL040

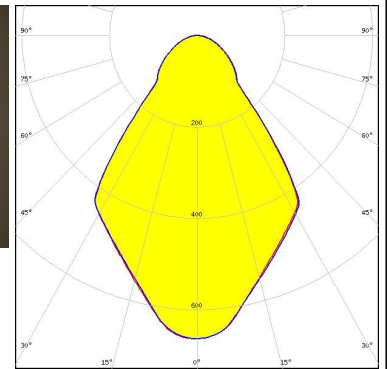
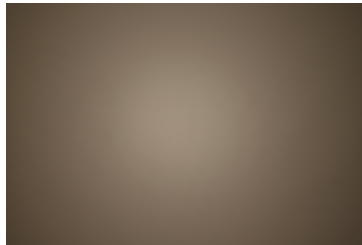

LED CMA1840  
 FWHM / FWTM 71.0° / 120.0°  
 Efficiency 93 %  
 Peak intensity 0.7 cd/lm  
 LEDs/each optic 1  
 Light colour White  
 Required components:  
 C14146\_LENINA-STD-BASE-CXA18

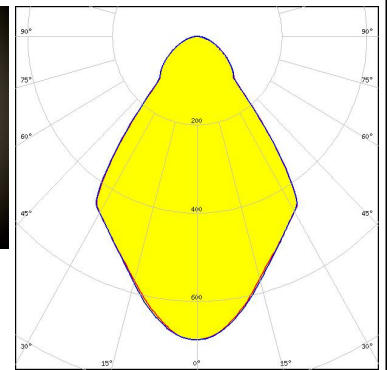
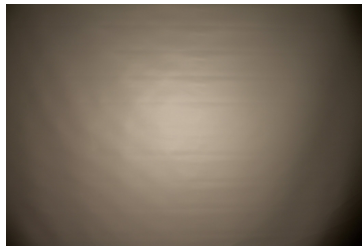

LED CMA2550  
 FWHM / FWTM 71.0° / 121.0°  
 Efficiency 94 %  
 Peak intensity 0.7 cd/lm  
 LEDs/each optic 1  
 Light colour White  
 Required components:  
 C13324\_LENINA-STD-BASE-CXA25

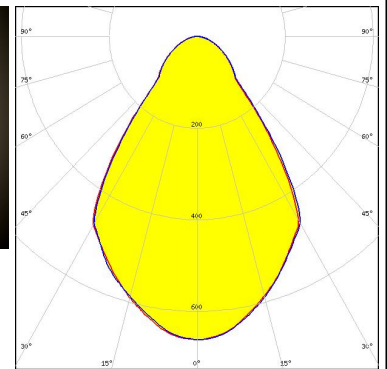
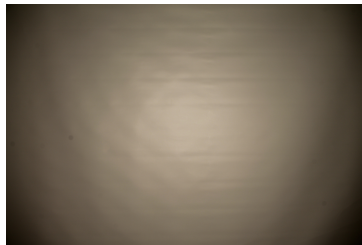

LED CMT14xx  
 FWHM / FWTM 75.0° / 124.0°  
 Efficiency 94 %  
 Peak intensity 0.7 cd/lm  
 LEDs/each optic 1  
 Light colour White  
 Required components:  
 C13868\_LENINA-STD-BASE-VERO13-18  
 Bender Wirth: 434 Typ L1

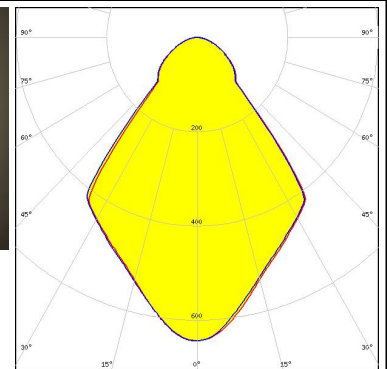
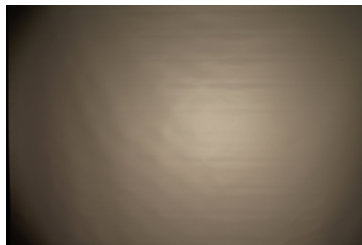

#### OPTICAL RESULTS (MEASURED):



LED CMT19xx  
 FWHM / FWTM 75.0° / 126.0°  
 Efficiency 94 %  
 Peak intensity 0.6 cd/m  
 LEDs/each optic 1  
 Light colour White  
 Required components:  
 C13868\_LENINA-STD-BASE-VERO13-18  
 Bender Wirth: 477 Typ L1

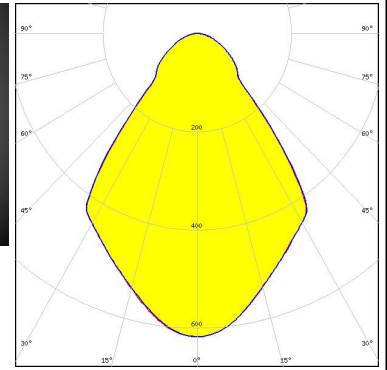
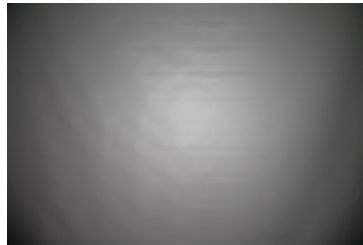

LED CMT19xx  
 FWHM / FWTM 74.0° / 124.0°  
 Efficiency 94 %  
 Peak intensity 0.6 cd/m  
 LEDs/each optic 1  
 Light colour White  
 Required components:  
 C12691\_LENINA-STD-BASE-CLL030

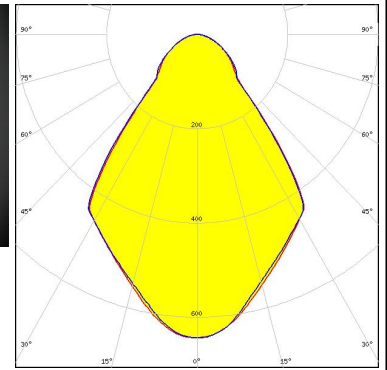
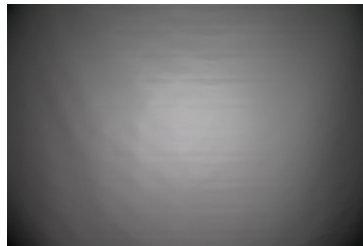



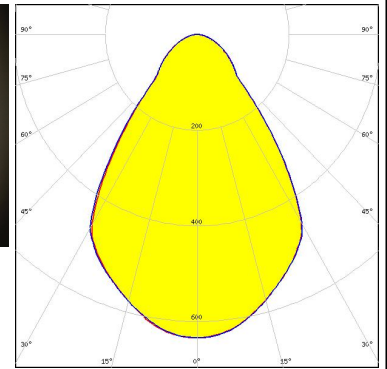
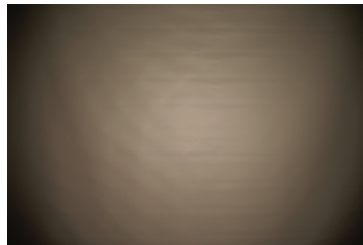

LED CMT28xx  
 FWHM / FWTM 72.0° / 123.0°  
 Efficiency 94 %  
 Peak intensity 0.6 cd/m  
 LEDs/each optic 1  
 Light colour White  
 Required components:  
 C12692\_LENINA-STD-BASE-CLL040

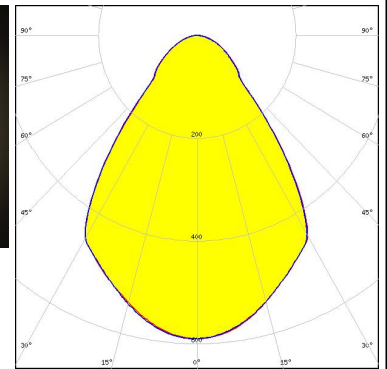
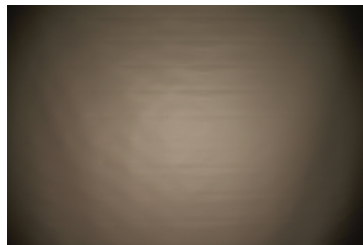

LED CMT28xx  
 FWHM / FWTM 75.0° / 126.0°  
 Efficiency 93 %  
 Peak intensity 0.6 cd/m  
 LEDs/each optic 1  
 Light colour White  
 Required components:  
 C13867\_LENINA-STD-BASE-VERO29  
 Bender Wirth: 471 Typ L3

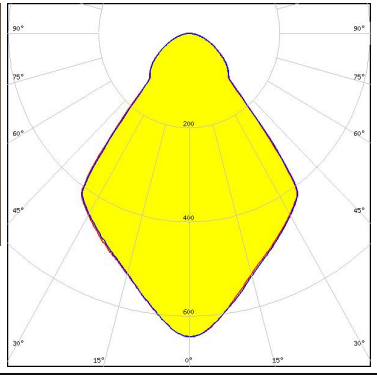

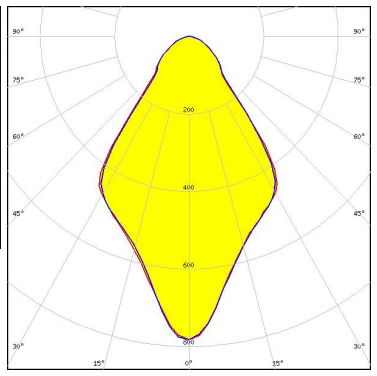
#### OPTICAL RESULTS (MEASURED):

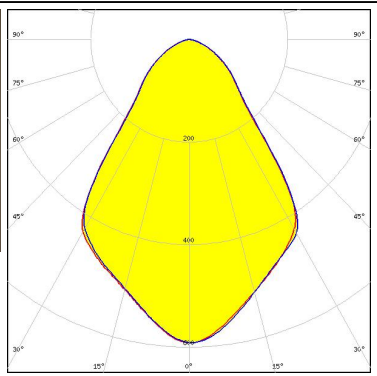
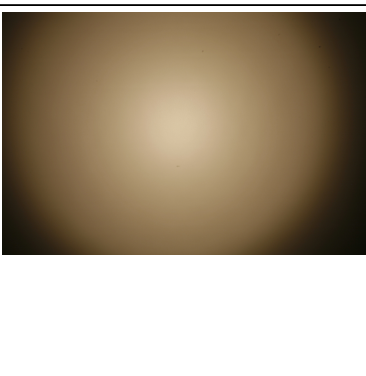
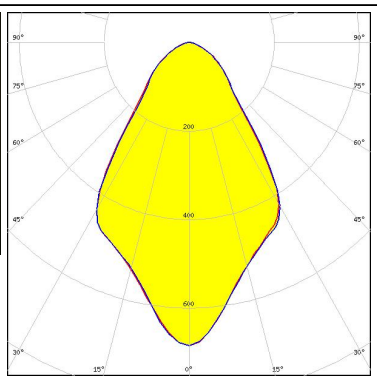
<p><b>CREE</b> LEDs</p> <p>LED CXA/B 15xx            FWHM / FWTM 75.0° / 124.0°            Efficiency 93 %            Peak intensity 0.6 cd/m            LEDs/each optic 1            Light colour White</p> <p>Required components:            C13868_LENINA-STD-BASE-VERO13-18            Bender Wirth: 441 Typ L1</p>		
<p><b>CREE</b> LEDs</p> <p>LED CXA/B 15xx            FWHM / FWTM 70.0° / 113.0°            Efficiency 91 %            Peak intensity 0.8 cd/m            LEDs/each optic 1            Light colour White</p> <p>Required components:            C13186_LENINA-STD-BASE-CXA15</p>		
<p><b>CREE</b> LEDs</p> <p>LED CXA/B 15xx            FWHM / FWTM 73.0° / 125.0°            Efficiency 89 %            Peak intensity 0.6 cd/m            LEDs/each optic 1            Light colour White</p> <p>Required components:            C13868_LENINA-STD-BASE-VERO13-18            C12606_LENINA-DL            Bender Wirth: 441 Typ L1</p>		
<p><b>CREE</b> LEDs</p> <p>LED CXA/B 15xx            FWHM / FWTM 69.0° / 120.0°            Efficiency 86 %            Peak intensity 0.7 cd/m            LEDs/each optic 1            Light colour White</p> <p>Required components:            C13186_LENINA-STD-BASE-CXA15            C12606_LENINA-DL</p>		

#### OPTICAL RESULTS (MEASURED):



LED CXA/B 1816 & CXA/B 1820 & CXA 1850  
 FWHM / FWTM 74.0° / 125.0°  
 Efficiency 89 %  
 Peak intensity 0.6 cd/lm  
 LEDs/each optic 1  
 Light colour White  
 Required components:  
 C13868\_LENINA-STD-BASE-VERO13-18  
 C12606\_LENINA-DL  
 Bender Wirth: 437 Typ L1

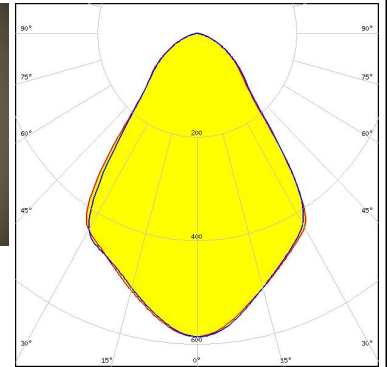
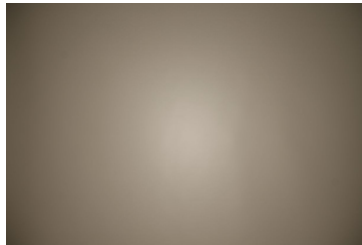

LED CXA/B 1816 & CXA/B 1820 & CXA 1850  
 FWHM / FWTM 73.0° / 124.0°  
 Efficiency 94 %  
 Peak intensity 0.8 cd/lm  
 LEDs/each optic 1  
 Light colour White  
 Required components:  
 C14146\_LENINA-STD-BASE-CXA18

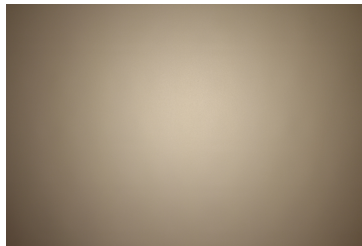

LED CXA/B 1816 & CXA/B 1820 & CXA 1850  
 FWHM / FWTM 75.0° / 125.0°  
 Efficiency 93 %  
 Peak intensity 0.6 cd/lm  
 LEDs/each optic 1  
 Light colour White  
 Required components:  
 C13868\_LENINA-STD-BASE-VERO13-18  
 Bender Wirth: 437 Typ L1

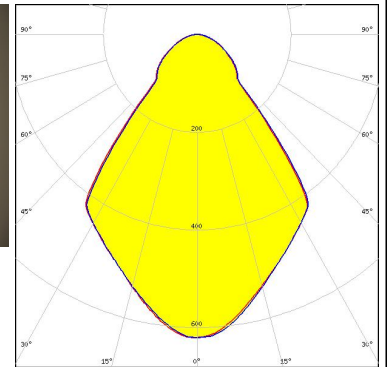
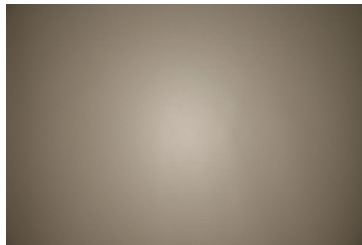

LED CXA/B 1816 & CXA/B 1820 & CXA 1850  
 FWHM / FWTM 73.0° / 124.0°  
 Efficiency 94 %  
 Peak intensity 0.8 cd/lm  
 LEDs/each optic 1  
 Light colour White  
 Required components:  
 C14146\_LENINA-STD-BASE-CXA18  
 C12606\_LENINA-DL





#### OPTICAL RESULTS (MEASURED):



LED CXA/B 1830  
 FWHM / FWTM 75.0° / 126.0°  
 Efficiency 94 %  
 Peak intensity 0.6 cd/lm  
 LEDs/each optic 1  
 Light colour White  
 Required components:  
 C13868\_LENINA-STD-BASE-VERO13-18  
 Bender Wirth: 437 Typ L1

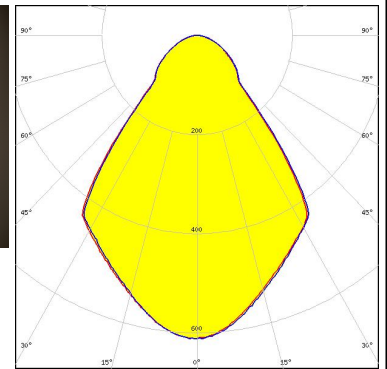
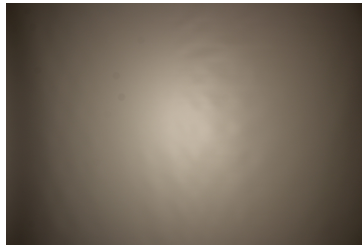

LED CXA/B 1830  
 FWHM / FWTM 74.0° / 126.0°  
 Efficiency 89 %  
 Peak intensity 0.6 cd/lm  
 LEDs/each optic 1  
 Light colour White  
 Required components:  
 C13868\_LENINA-STD-BASE-VERO13-18  
 C12606\_LENINA-DL  
 Bender Wirth: 437 Typ L1

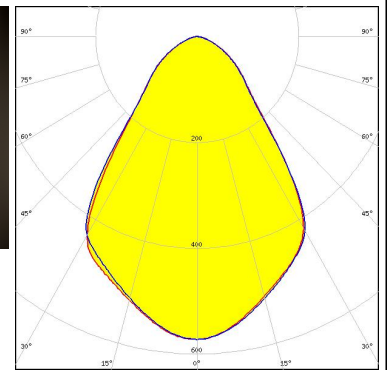
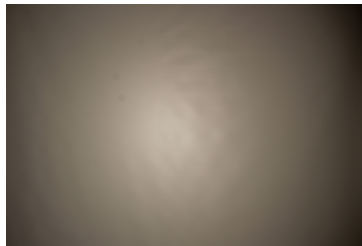

LED CXA/B 25xx  
 FWHM / FWTM 70.0° / 120.0°  
 Efficiency 89 %  
 Peak intensity 0.7 cd/lm  
 LEDs/each optic 1  
 Light colour White  
 Required components:  
 C13324\_LENINA-STD-BASE-CXA25

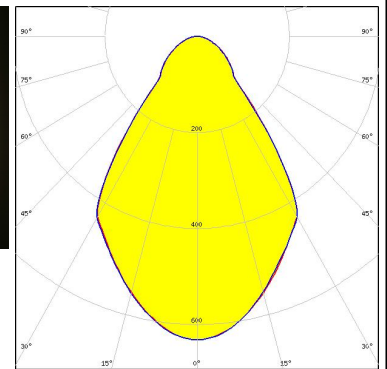
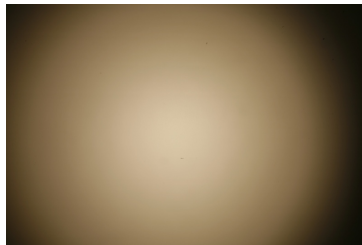

LED CXA/B 25xx  
 FWHM / FWTM 70.0° / 120.0°  
 Efficiency 84 %  
 Peak intensity 0.6 cd/lm  
 LEDs/each optic 1  
 Light colour White  
 Required components:  
 C13324\_LENINA-STD-BASE-CXA25  
 C12606\_LENINA-DL

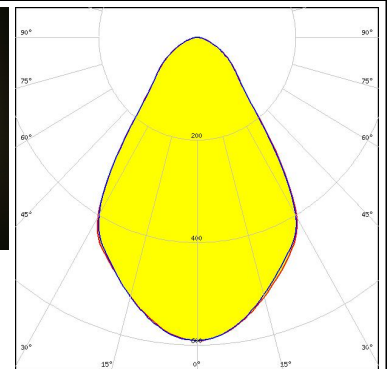
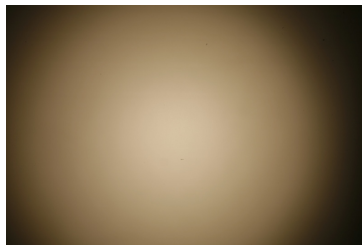

#### OPTICAL RESULTS (MEASURED):



LED CXA/B 30xx  
 FWHM / FWTM 77.0° / 124.0°  
 Efficiency 87 %  
 Peak intensity 0.6 cd/lm  
 LEDs/each optic 1  
 Light colour White  
 Required components:  
 C12606\_LENINA-DL  
 IDEAL: 50-2234C + 50-2100LN

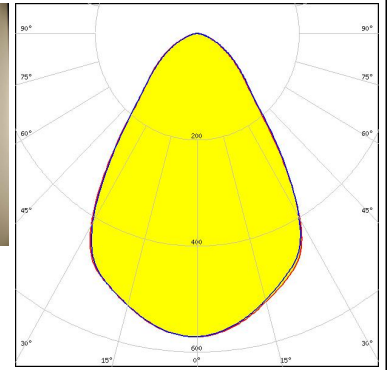
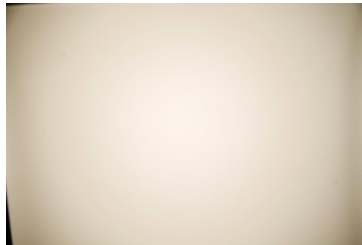

LED CXA/B 30xx  
 FWHM / FWTM 72.0° / 123.0°  
 Efficiency 91 %  
 Peak intensity 0.6 cd/lm  
 LEDs/each optic 1  
 Light colour White  
 Required components:  
 IDEAL: 50-2234C + 50-2100LN

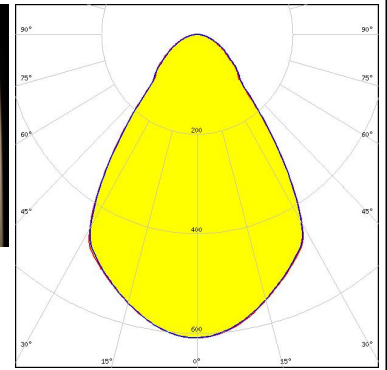
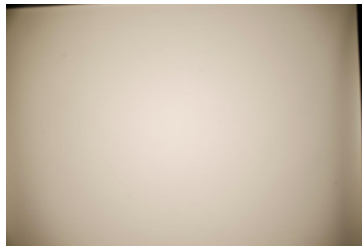

LED CXA2011  
 FWHM / FWTM 70.0° / 123.0°  
 Efficiency 82 %  
 Peak intensity 0.6 cd/lm  
 LEDs/each optic 1  
 Light colour White  
 Required components:  
 C12105\_LENINA-STD-BASE-CXA20  
 C12606\_LENINA-DL

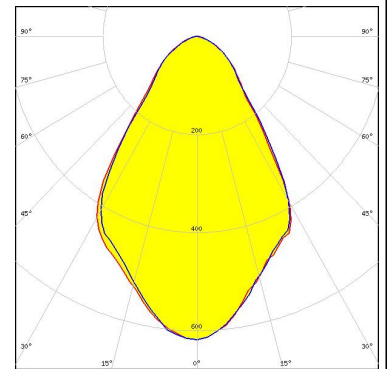

LED CXA2011  
 FWHM / FWTM 72.0° / 121.0°  
 Efficiency 87 %  
 Peak intensity 0.7 cd/lm  
 LEDs/each optic 1  
 Light colour White  
 Required components:  
 C12105\_LENINA-STD-BASE-CXA20

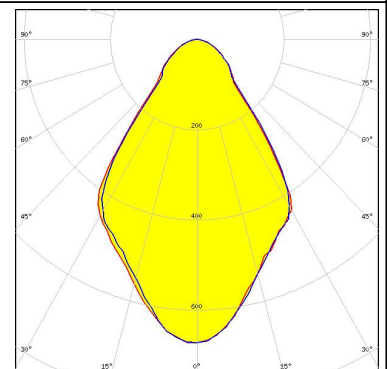

#### OPTICAL RESULTS (MEASURED):

#### EVERLIGHT

LED CHI3030 19W  
 FWHM / FWTM 75.0° / 130.0°  
 Efficiency 94 %  
 Peak intensity 0.6 cd/lm  
 LEDs/each optic 1  
 Light colour White

Required components:

C13867\_LENINA-STD-BASE-VERO29  
 C12606\_LENINA-DL  
 Bender Wirth: 468 Typ L3



#### EVERLIGHT

LED CHI3030 29W  
 FWHM / FWTM 75.0° / 128.0°  
 Efficiency 90 %  
 Peak intensity 0.5 cd/lm  
 LEDs/each optic 1  
 Light colour White

Required components:

C13867\_LENINA-STD-BASE-VERO29  
 C12606\_LENINA-DL  
 Bender Wirth: 468 Typ L3

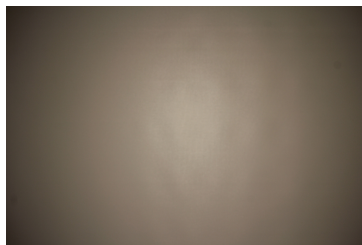

#### LUMILEDS

LED LUXEON CoB 1202/1203  
 FWHM / FWTM 74.0° / 125.0°  
 Efficiency 89 %  
 Peak intensity 0.6 cd/lm  
 LEDs/each optic 1  
 Light colour White

Required components:

C13868\_LENINA-STD-BASE-VERO13-18  
 C12606\_LENINA-DL  
 Bender Wirth: 438 Typ L1

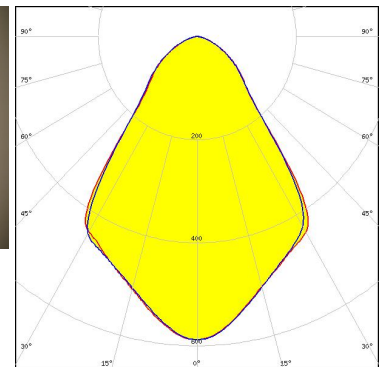
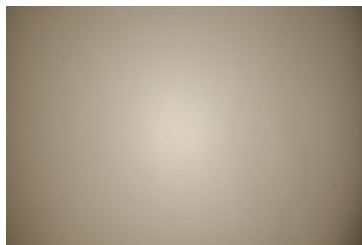

#### LUMILEDS

LED LUXEON CoB 1202/1203  
 FWHM / FWTM 76.0° / 126.0°  
 Efficiency 93 %  
 Peak intensity 0.6 cd/lm  
 LEDs/each optic 1  
 Light colour White

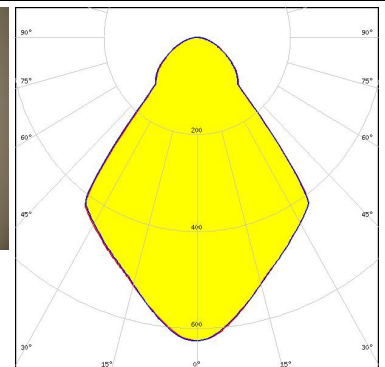
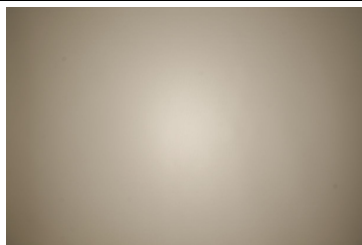

Required components:

C13868\_LENINA-STD-BASE-VERO13-18  
 Bender Wirth: 438 Typ L1





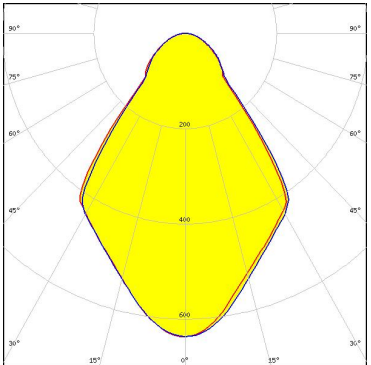
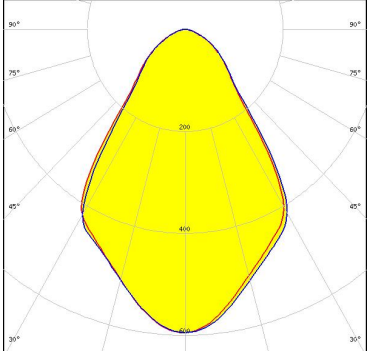
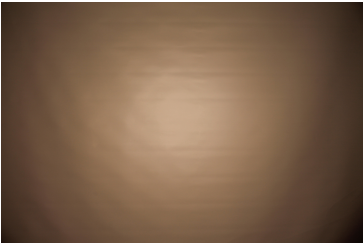
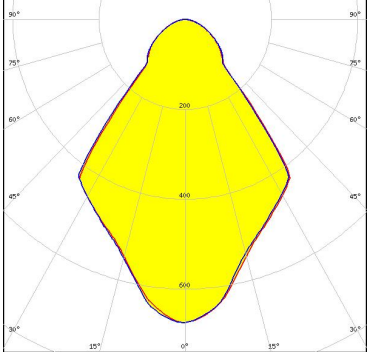

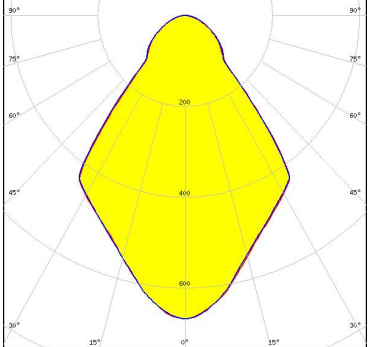



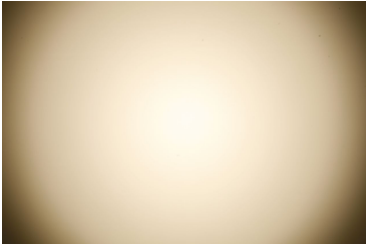
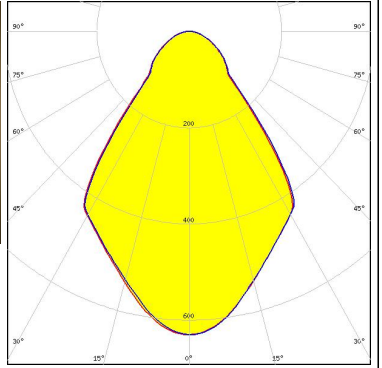
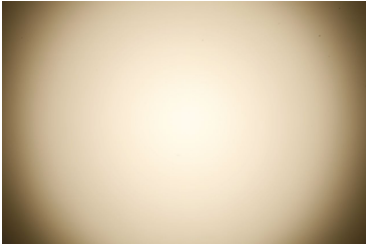
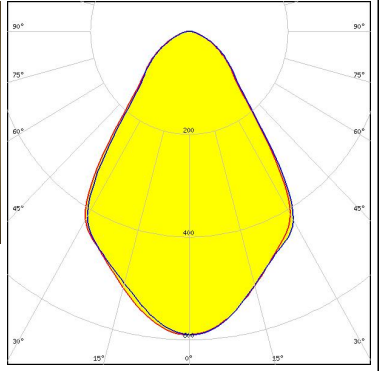
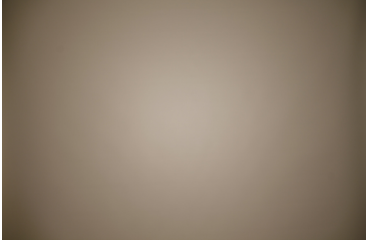
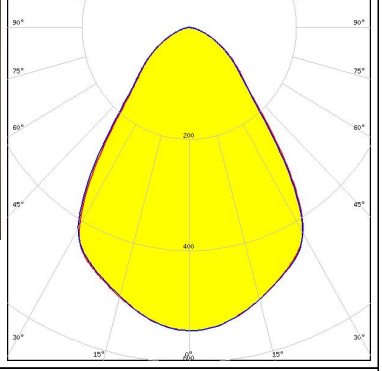
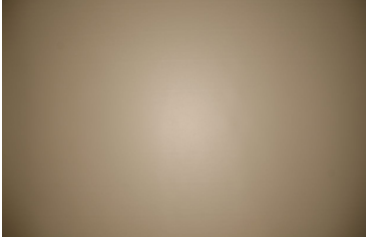
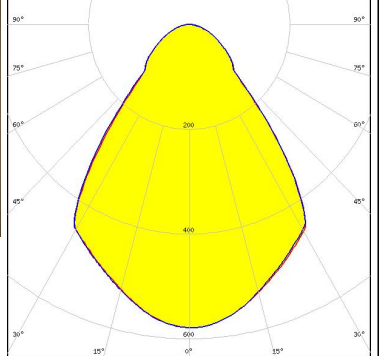

#### OPTICAL RESULTS (MEASURED):

<p><b>LUMILEDS</b></p> <p>LED LUXEON CoB 1204/1205</p> <p>FWHM / FWTM 73.0° / 123.0°</p> <p>Efficiency 90 %</p> <p>Peak intensity 0.6 cd/lm</p> <p>LEDs/each optic 1</p> <p>Light colour White</p> <p>Required components: C12292_LENASTD-BASE-MEZ</p>	
<p><b>LUMILEDS</b></p> <p>LED LUXEON CoB 1204/1205</p> <p>FWHM / FWTM 71.0° / 123.0°</p> <p>Efficiency 86 %</p> <p>Peak intensity 0.6 cd/lm</p> <p>LEDs/each optic 1</p> <p>Light colour White</p> <p>Required components: C12292_LENASTD-BASE-MEZ C12606_LENINA-DL</p>	
<p><b>LUMILEDS</b></p> <p>LED LUXEON CoB 1204HD</p> <p>FWHM / FWTM 74.0° / 122.0°</p> <p>Efficiency 94 %</p> <p>Peak intensity 0.7 cd/lm</p> <p>LEDs/each optic 1</p> <p>Light colour White</p> <p>Required components: C11981_LENASTD-BASE-COB-L110</p>	 
<p><b>LUMILEDS</b></p> <p>LED LUXEON CoB 1205HD</p> <p>FWHM / FWTM 74.0° / 122.0°</p> <p>Efficiency 94 %</p> <p>Peak intensity 0.7 cd/lm</p> <p>LEDs/each optic 1</p> <p>Light colour White</p> <p>Required components: C11981_LENASTD-BASE-COB-L110</p>	 

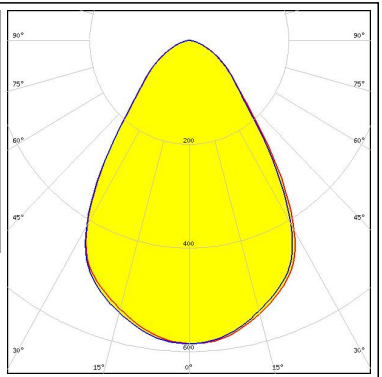
#### OPTICAL RESULTS (MEASURED):

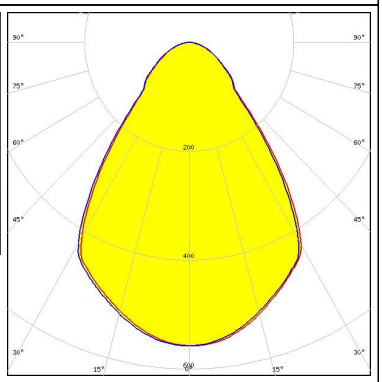
<p><b>LUMILEDS</b></p> <p>LED LUXEON CoB 1208</p> <p>FWHM / FWTM 73.0° / 123.0°</p> <p>Efficiency 91 %</p> <p>Peak intensity 0.6 cd/lm</p> <p>LEDs/each optic 1</p> <p>Light colour White</p> <p>Required components: C12292_LENINA-STD-BASE-MEZ</p>		
<p><b>LUMILEDS</b></p> <p>LED LUXEON CoB 1208</p> <p>FWHM / FWTM 72.0° / 124.0°</p> <p>Efficiency 86 %</p> <p>Peak intensity 0.6 cd/lm</p> <p>LEDs/each optic 1</p> <p>Light colour White</p> <p>Required components: C12292_LENINA-STD-BASE-MEZ C12606_LENINA-DL</p>		
<p><b>LUMILEDS</b></p> <p>LED LUXEON CoB 1211</p> <p>FWHM / FWTM 75.0° / 127.0°</p> <p>Efficiency 88 %</p> <p>Peak intensity 0.5 cd/lm</p> <p>LEDs/each optic 1</p> <p>Light colour White</p> <p>Required components: C13867_LENINA-STD-BASE-VERO29 C12606_LENINA-DL Bender Wirth: 431 Typ L3</p>		
<p><b>LUMILEDS</b></p> <p>LED LUXEON CoB 1211</p> <p>FWHM / FWTM 76.0° / 127.0°</p> <p>Efficiency 93 %</p> <p>Peak intensity 0.6 cd/lm</p> <p>LEDs/each optic 1</p> <p>Light colour White</p> <p>Required components: C13867_LENINA-STD-BASE-VERO29 Bender Wirth: 431 Typ L3</p>		

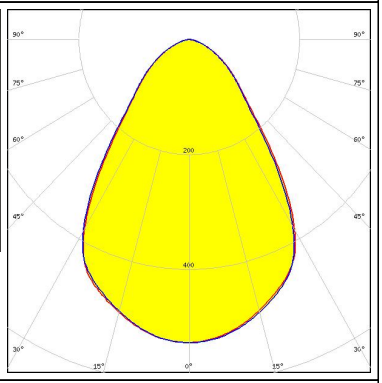
#### OPTICAL RESULTS (MEASURED):

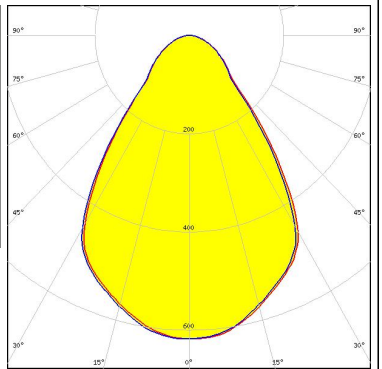
<p><b>LUMILEDS</b></p> <p>LED LUXEON CoB 1213/1216/1812</p> <p>FWHM / FWTM 72.0° / 125.0°</p> <p>Efficiency 90 %</p> <p>Peak intensity 0.6 cd/m</p> <p>LEDs/each optic 1</p> <p>Light colour White</p> <p>Required components: C12692_LENASTD-BASE-CLL040 C12606_LENINA-DL</p>		
<p><b>LUMILEDS</b></p> <p>LED LUXEON CoB 1213/1216/1812</p> <p>FWHM / FWTM 74.0° / 127.0°</p> <p>Efficiency 88 %</p> <p>Peak intensity 0.6 cd/m</p> <p>LEDs/each optic 1</p> <p>Light colour White</p> <p>Required components: A.A.G. STUCCHI: 8102-G2 + S-8000-12</p>		
<p><b>LUMILEDS</b></p> <p>LED LUXEON CoB 1213/1216/1812</p> <p>FWHM / FWTM 73.0° / 126.0°</p> <p>Efficiency 83 %</p> <p>Peak intensity 0.5 cd/m</p> <p>LEDs/each optic 1</p> <p>Light colour White</p> <p>Required components: C12606_LENINA-DL A.A.G. STUCCHI: 8102-G2 + S-8000-12</p>		
<p><b>LUMILEDS</b></p> <p>LED LUXEON CoB 1213/1216/1812</p> <p>FWHM / FWTM 73.0° / 124.0°</p> <p>Efficiency 94 %</p> <p>Peak intensity 0.6 cd/m</p> <p>LEDs/each optic 1</p> <p>Light colour White</p> <p>Required components: C12692_LENASTD-BASE-CLL040</p>		

#### OPTICAL RESULTS (MEASURED):

##### LUMILEDS

LED LUXEON K12  
FWHM / FWTM 68.0° / 118.0°  
Efficiency 83 %  
Peak intensity 0.6 cd/lm  
LEDs/each optic 1  
Light colour White

Required components:

C12924\_LENASTD-BASE-LUXEON-K  
C12606\_LENINA-DL

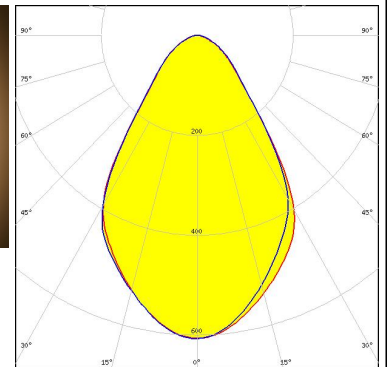
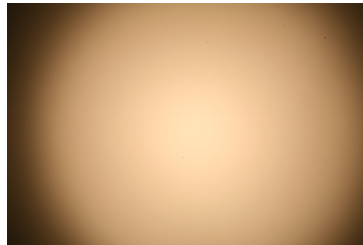

##### LUMILEDS

LED LUXEON K12  
FWHM / FWTM 72.0° / 115.0°  
Efficiency 90 %  
Peak intensity 0.7 cd/lm  
LEDs/each optic 1  
Light colour White

Required components:

C12924\_LENASTD-BASE-LUXEON-K

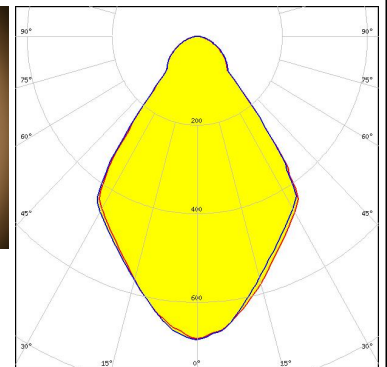
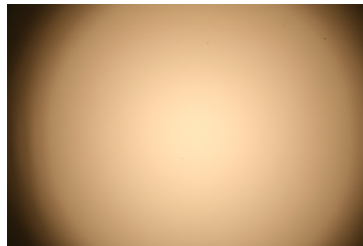

##### LUMILEDS

LED LUXEON K16  
FWHM / FWTM 72.0° / 116.0°  
Efficiency 86 %  
Peak intensity 0.6 cd/lm  
LEDs/each optic 1  
Light colour White

Required components:

C12924\_LENASTD-BASE-LUXEON-K

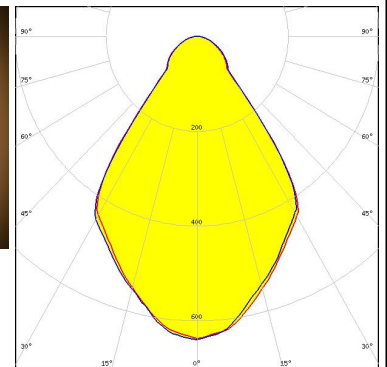
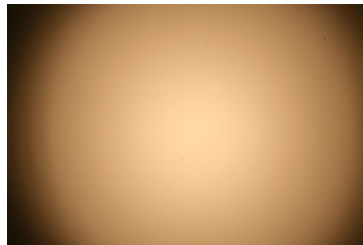

##### LUMILEDS

LED LUXEON K16  
FWHM / FWTM 68.0° / 120.0°  
Efficiency 80 %  
Peak intensity 0.6 cd/lm  
LEDs/each optic 1  
Light colour White



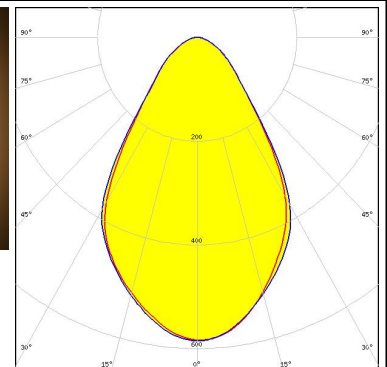
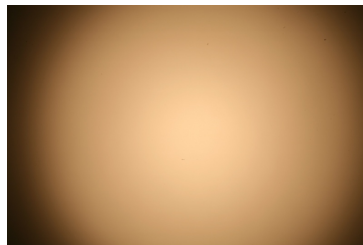

Required components:

C12924\_LENASTD-BASE-LUXEON-K  
C12606\_LENINA-DL



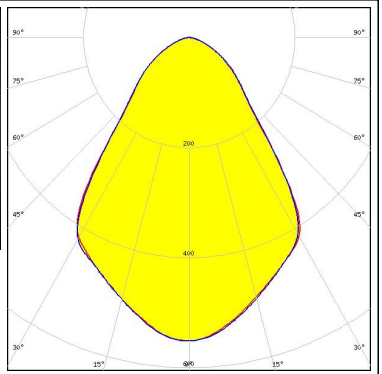
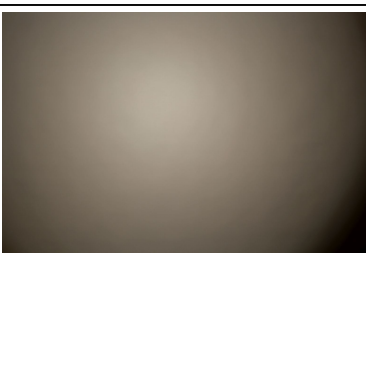
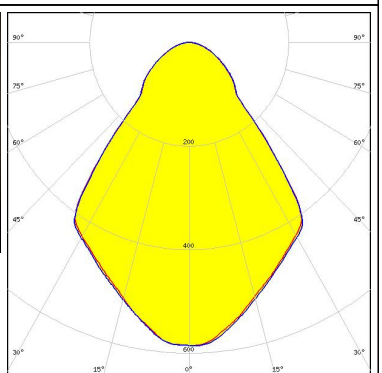

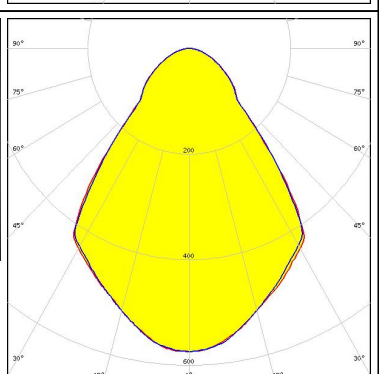
#### OPTICAL RESULTS (MEASURED):

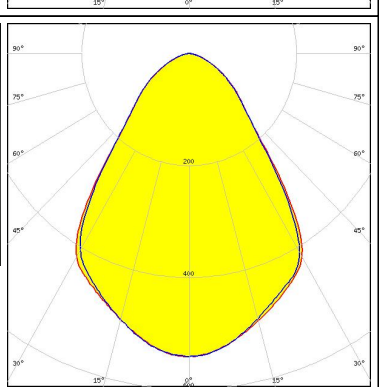
<p><b>LUMINUS</b></p> <p>LED CDM-14 (Dim-To-Warm)</p> <p>FWHM / FWTM 75.0° / 128.0°</p> <p>Efficiency 89 %</p> <p>Peak intensity 0.6 cd/lm</p> <p>LEDs/each optic 1</p> <p>Light colour White</p> <p>Required components:            C13868_LENINA-STD-BASE-VERO13-18            C12606_LENINA-DL            Bender Wirth: 491 Typ L2</p>		
<p><b>LUMINUS</b></p> <p>LED CDM-14 (Dim-To-Warm)</p> <p>FWHM / FWTM 77.0° / 129.0°</p> <p>Efficiency 93 %</p> <p>Peak intensity 0.6 cd/lm</p> <p>LEDs/each optic 1</p> <p>Light colour White</p> <p>Required components:            C13868_LENINA-STD-BASE-VERO13-18            Bender Wirth: 491 Typ L2</p>		
<p><b>LUMINUS</b></p> <p>LED CDM-18 (Dim-To-Warm)</p> <p>FWHM / FWTM 76.0° / 129.0°</p> <p>Efficiency 93 %</p> <p>Peak intensity 0.6 cd/lm</p> <p>LEDs/each optic 1</p> <p>Light colour White</p> <p>Required components:            C13868_LENINA-STD-BASE-VERO13-18            Bender Wirth: 491 Typ L2</p>		
<p><b>LUMINUS</b></p> <p>LED CDM-18 (Dim-To-Warm)</p> <p>FWHM / FWTM 75.0° / 128.0°</p> <p>Efficiency 89 %</p> <p>Peak intensity 0.5 cd/lm</p> <p>LEDs/each optic 1</p> <p>Light colour White</p> <p>Required components:            C13868_LENINA-STD-BASE-VERO13-18            C12606_LENINA-DL            Bender Wirth: 491 Typ L2</p>		

#### OPTICAL RESULTS (MEASURED):



LED CDM-9 (Dim-To-Warm)  
 FWHM / FWTM 76.0° / 128.0°  
 Efficiency 92 %  
 Peak intensity 0.6 cd/lm  
 LEDs/each optic 1  
 Light colour White  
 Required components:  
 C13868\_LENASTD-BASE-VERO13-18  
 Bender Wirth: 490 Typ L1

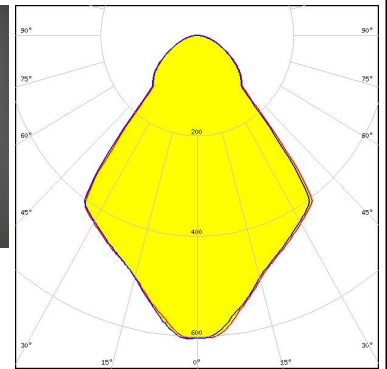

LED CDM-9 (Dim-To-Warm)  
 FWHM / FWTM 74.0° / 127.0°  
 Efficiency 88 %  
 Peak intensity 0.6 cd/lm  
 LEDs/each optic 1  
 Light colour White  
 Required components:  
 C13868\_LENASTD-BASE-VERO13-18  
 Bender Wirth: 490 Typ L1

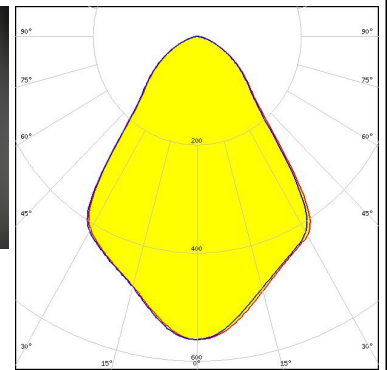
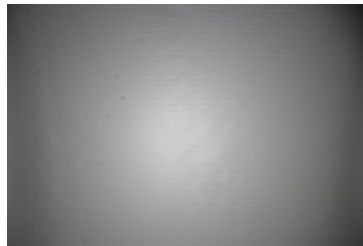



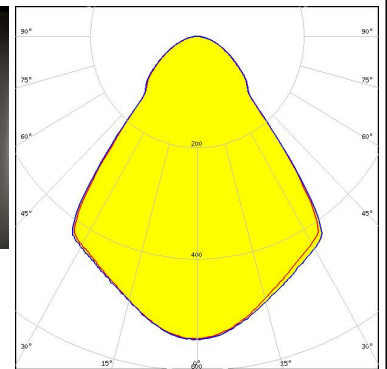
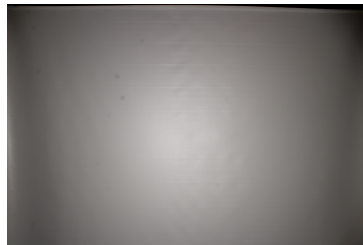

LED CTM-14 (Tunable White)  
 FWHM / FWTM 77.0° / 131.0°  
 Efficiency 92 %  
 Peak intensity 0.6 cd/lm  
 LEDs/each optic 1  
 Light colour White  
 Required components:  
 C13867\_LENASTD-BASE-VERO29  
 Bender Wirth: 442 Typ L3

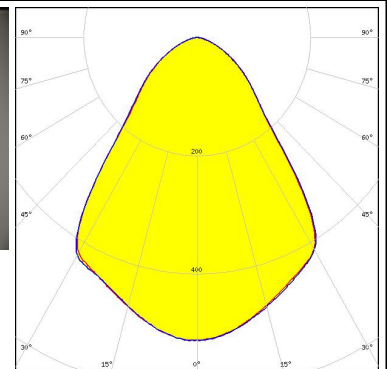

LED CTM-14 (Tunable White)  
 FWHM / FWTM 76.0° / 129.0°  
 Efficiency 87 %  
 Peak intensity 0.5 cd/lm  
 LEDs/each optic 1  
 Light colour White  
 Required components:  
 C13867\_LENASTD-BASE-VERO29  
 C12606\_LENINA-DL  
 Bender Wirth: 442 Typ L3

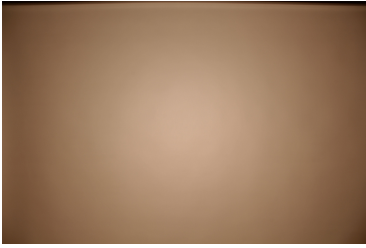
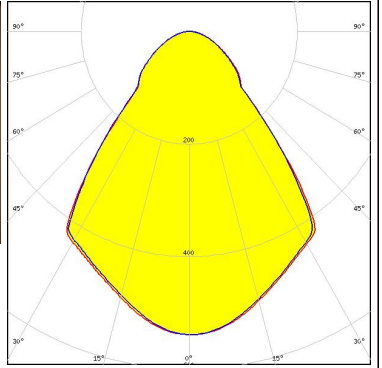

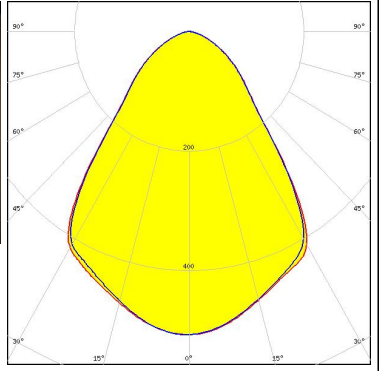
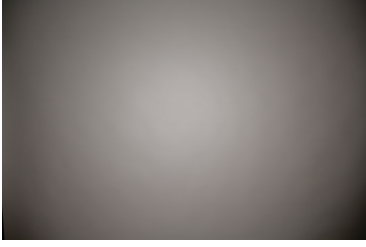
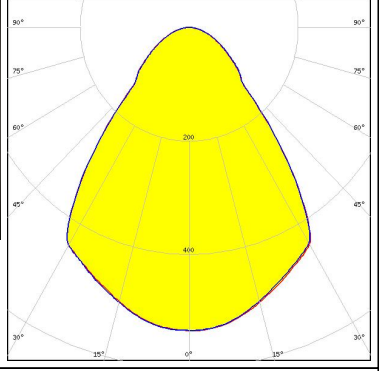

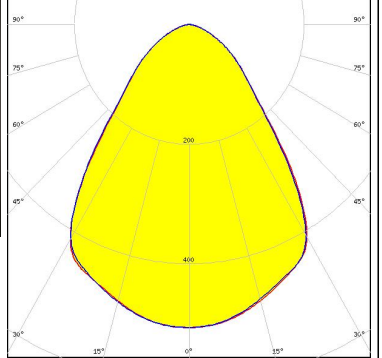
#### OPTICAL RESULTS (MEASURED):



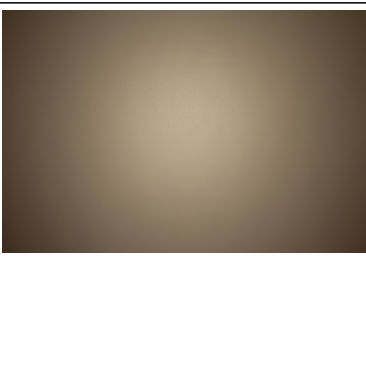
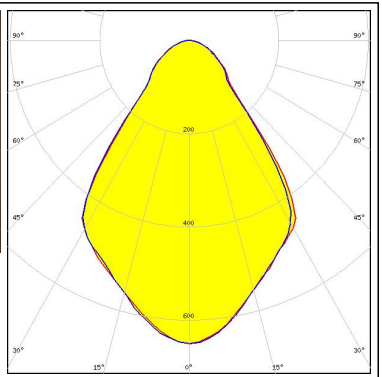

<p><b>LUMINUS</b></p> <p>LED CTM-18 (Tunable White)            FWHM / FWTM 78.0° / 131.0°            Efficiency 92 %            Peak intensity 0.5 cd/lm            LEDs/each optic 1            Light colour White</p> <p>Required components:            C13867_LENINA-STD-BASE-VERO29            Bender Wirth: 442 Typ L3</p>		
<p><b>LUMINUS</b></p> <p>LED CTM-18 (Tunable White)            FWHM / FWTM 77.0° / 129.0°            Efficiency 87 %            Peak intensity 0.5 cd/lm            LEDs/each optic 1            Light colour White</p> <p>Required components:            C13867_LENINA-STD-BASE-VERO29            C12606_LENINA-DL            Bender Wirth: 442 Typ L3</p>		
<p><b>LUMINUS</b></p> <p>LED CTM-22 (Tunable White)            FWHM / FWTM 78.0° / 131.0°            Efficiency 92 %            Peak intensity 0.5 cd/lm            LEDs/each optic 1            Light colour White</p> <p>Required components:            C13867_LENINA-STD-BASE-VERO29            Bender Wirth: 494 Typ L3</p>		
<p><b>LUMINUS</b></p> <p>LED CTM-22 (Tunable White)            FWHM / FWTM 77.0° / 129.0°            Efficiency 88 %            Peak intensity 0.5 cd/lm            LEDs/each optic 1            Light colour White</p> <p>Required components:            C13867_LENINA-STD-BASE-VERO29            C12606_LENINA-DL            Bender Wirth: 494 Typ L3</p>		

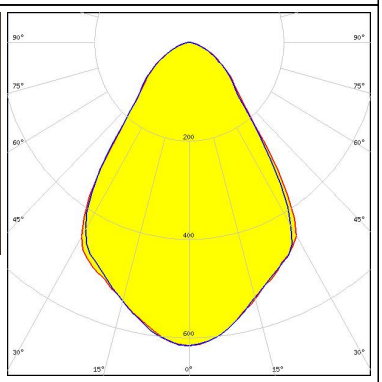
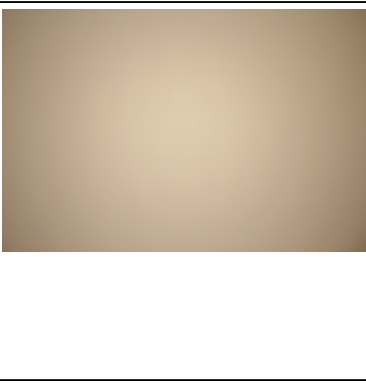
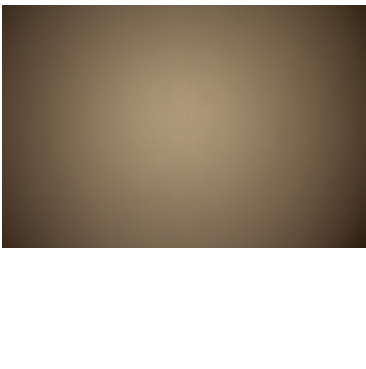

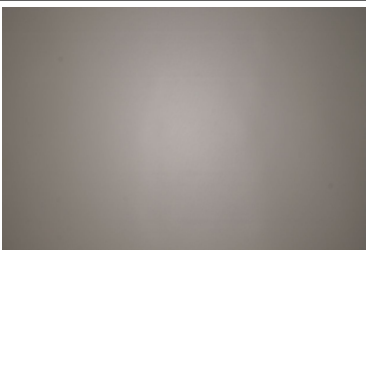
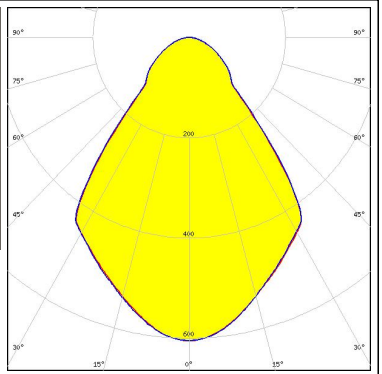

#### OPTICAL RESULTS (MEASURED):

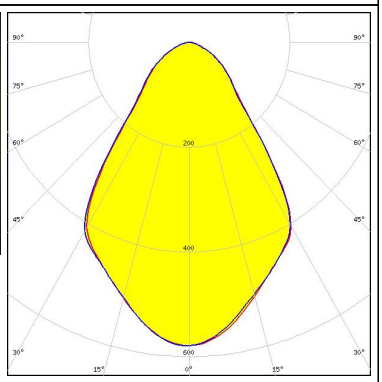
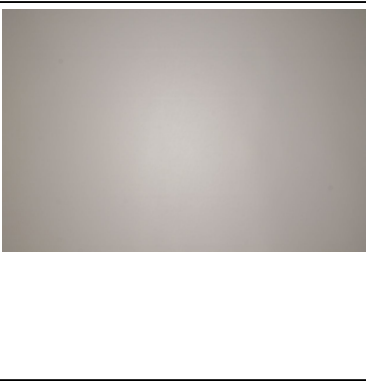
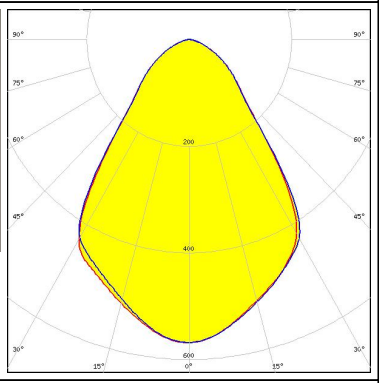
<p><b>LUMINUS</b></p> <p>LED CxM-14 (19x19)            FWHM / FWTM 74.0° / 124.0°            Efficiency 94 %            Peak intensity 0.7 cd/lm            LEDs/each optic 1            Light colour White            Required components:            C12691_LENINA-STD-BASE-CLL030</p>		
<p><b>LUMINUS</b></p> <p>LED CxM-14 (19x19)            FWHM / FWTM 73.0° / 125.0°            Efficiency 91 %            Peak intensity 0.6 cd/lm            LEDs/each optic 1            Light colour White            Required components:            C12691_LENINA-STD-BASE-CLL030            C12606_LENINA-DL</p>		
<p><b>LUMINUS</b></p> <p>LED CxM-22 (28x28)            FWHM / FWTM 73.0° / 128.0°            Efficiency 94 %            Peak intensity 0.6 cd/lm            LEDs/each optic 1            Light colour White            Required components:            C12692_LENINA-STD-BASE-CLL040</p>		
<p><b>LUMINUS</b></p> <p>LED CxM-22 (28x28)            FWHM / FWTM 73.0° / 128.0°            Efficiency 91 %            Peak intensity 0.6 cd/lm            LEDs/each optic 1            Light colour White            Required components:            C12692_LENINA-STD-BASE-CLL040            C12606_LENINA-DL</p>		

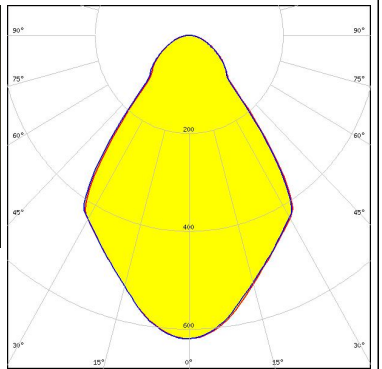

#### OPTICAL RESULTS (MEASURED):

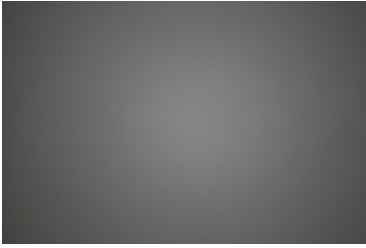
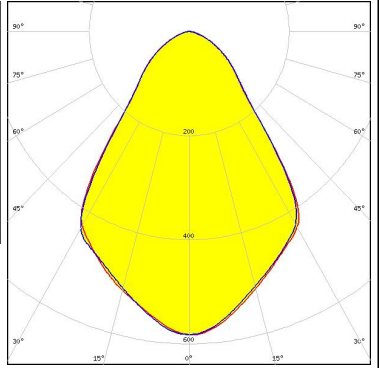
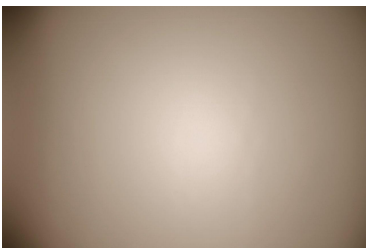
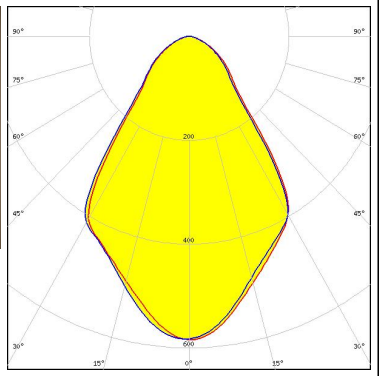
<p><b>NICHIA</b></p> <p>LED COB J-Type            FWHM / FWTM 76.0° / 127.0°            Efficiency 94 %            Peak intensity 0.6 cd/lm            LEDs/each optic 1            Light colour White</p> <p>Required components:            C13868_LENASTD-BASE-VERO13-18            Bender Wirth: 463 Typ L2</p>		
<p><b>NICHIA</b></p> <p>LED COB J-Type            FWHM / FWTM 72.0° / 124.0°            Efficiency 84 %            Peak intensity 0.6 cd/lm            LEDs/each optic 1            Light colour White</p> <p>Required components:            C12292_LENASTD-BASE-MEZ            C12606_LENINA-DL</p>		
<p><b>NICHIA</b></p> <p>LED COB J-Type            FWHM / FWTM 74.0° / 126.0°            Efficiency 89 %            Peak intensity 0.6 cd/lm            LEDs/each optic 1            Light colour White</p> <p>Required components:            C13868_LENASTD-BASE-VERO13-18            C12606_LENINA-DL            Bender Wirth: 463 Typ L2</p>		
<p><b>NICHIA</b></p> <p>LED COB J-Type            FWHM / FWTM 73.0° / 123.0°            Efficiency 89 %            Peak intensity 0.6 cd/lm            LEDs/each optic 1            Light colour White</p> <p>Required components:            C12292_LENASTD-BASE-MEZ</p>		

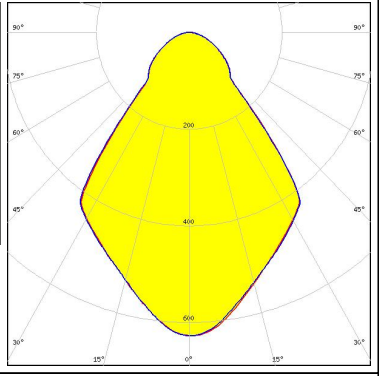
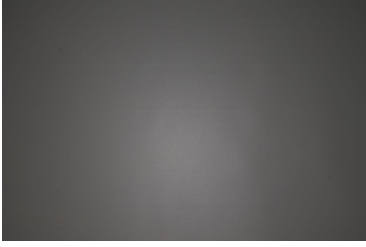
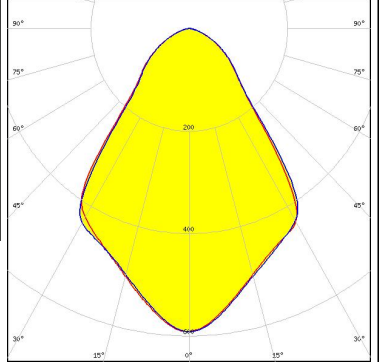
#### OPTICAL RESULTS (MEASURED):

<p><b>NICHIA</b></p> <p>LED COB L-Type (LES 11)</p> <p>FWHM / FWTM 73.0° / 125.0°</p> <p>Efficiency 89 %</p> <p>Peak intensity 0.6 cd/m</p> <p>LEDs/each optic 1</p> <p>Light colour White</p> <p>Required components:</p> <p>C13868_LENINA-STD-BASE-VERO13-18</p> <p>C12606_LENINA-DL</p> <p>Bender Wirth: 438 Typ L1</p>		
<p><b>NICHIA</b></p> <p>LED COB L-Type (LES 11)</p> <p>FWHM / FWTM 71.0° / 122.0°</p> <p>Efficiency 82 %</p> <p>Peak intensity 0.6 cd/m</p> <p>LEDs/each optic 1</p> <p>Light colour White</p> <p>Required components:</p> <p>C11981_LENINA-STD-BASE-COB-L110</p> <p>C12606_LENINA-DL</p>		
<p><b>NICHIA</b></p> <p>LED COB L-Type (LES 11)</p> <p>FWHM / FWTM 75.0° / 125.0°</p> <p>Efficiency 93 %</p> <p>Peak intensity 0.6 cd/m</p> <p>LEDs/each optic 1</p> <p>Light colour White</p> <p>Required components:</p> <p>C13868_LENINA-STD-BASE-VERO13-18</p> <p>Bender Wirth: 438 Typ L1</p>		
<p><b>NICHIA</b></p> <p>LED COB L-Type (LES 9)</p> <p>FWHM / FWTM 74.0° / 126.0°</p> <p>Efficiency 90 %</p> <p>Peak intensity 0.6 cd/m</p> <p>LEDs/each optic 1</p> <p>Light colour White</p> <p>Required components:</p> <p>C13868_LENINA-STD-BASE-VERO13-18</p> <p>C12606_LENINA-DL</p> <p>Bender Wirth: 438 Typ L1</p>		

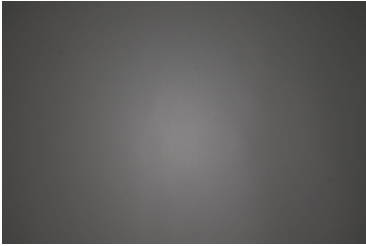
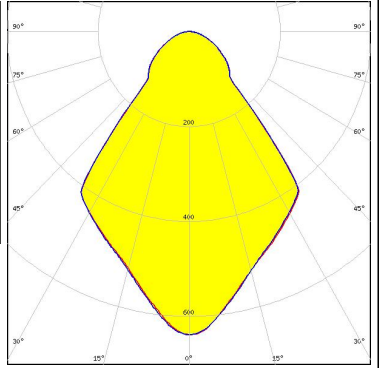
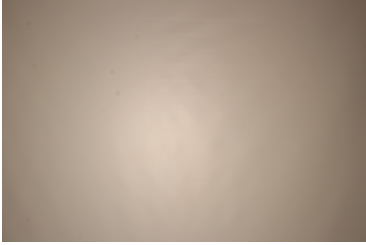
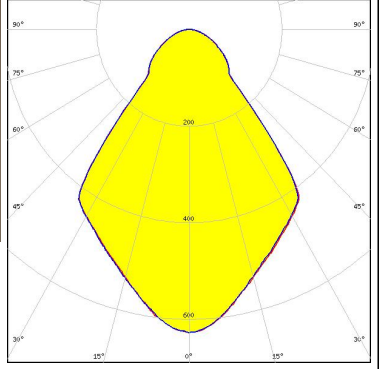
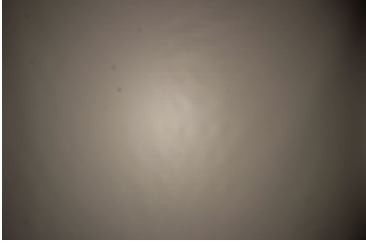
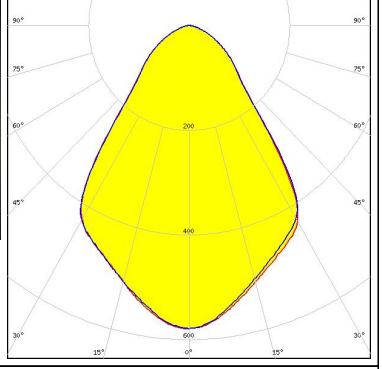
#### OPTICAL RESULTS (MEASURED):

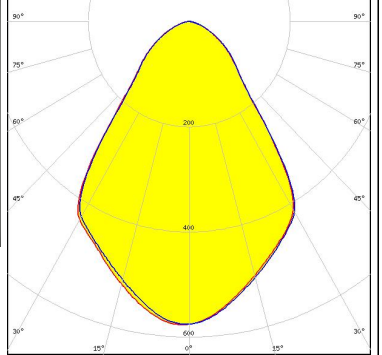
<p><b>NICHIA</b></p> <p>LED COB L-Type (LES 9)</p> <p>FWHM / FWTM 76.0° / 126.0°</p> <p>Efficiency 94 %</p> <p>Peak intensity 0.6 cd/m</p> <p>LEDs/each optic 1</p> <p>Light colour White</p> <p>Required components: C13868_LENINA-STD-BASE-VERO13-18 Bender Wirth: 438 Typ L1</p>		
<p><b>NICHIA</b></p> <p>LED NVCWJ024Z-V1MT: COB J-Type Tunable White</p> <p>FWHM / FWTM 75.0° / 125.0°</p> <p>Efficiency 93 %</p> <p>Peak intensity 0.6 cd/m</p> <p>LEDs/each optic 1</p> <p>Light colour White</p> <p>Required components: C13868_LENINA-STD-BASE-VERO13-18 Bender Wirth: 498 Typ L2</p>		
<p><b>NICHIA</b></p> <p>LED NVCWJ024Z-V1MT: COB J-Type Tunable White</p> <p>FWHM / FWTM 74.0° / 125.0°</p> <p>Efficiency 89 %</p> <p>Peak intensity 0.6 cd/m</p> <p>LEDs/each optic 1</p> <p>Light colour White</p> <p>Required components: C13868_LENINA-STD-BASE-VERO13-18 C12606_LENINA-DL Bender Wirth: 498 Typ L2</p>		
<p><b>OSRAM</b> Opto Semiconductors</p> <p>LED Soleriq S13</p> <p>FWHM / FWTM 73.0° / 126.0°</p> <p>Efficiency 89 %</p> <p>Peak intensity 0.6 cd/m</p> <p>LEDs/each optic 1</p> <p>Light colour White</p> <p>Required components: C13868_LENINA-STD-BASE-VERO13-18 C12606_LENINA-DL Bender Wirth: 437 Typ L1</p>		

#### OPTICAL RESULTS (MEASURED):

#### OSRAM

Opto Semiconductors

LED Soleriq S13  
 FWHM / FWTM 75.0° / 125.0°  
 Efficiency 93 %  
 Peak intensity 0.6 cd/lm  
 LEDs/each optic 1  
 Light colour White

Required components:

C13868\_LENASTD-BASE-VERO13-18  
 Bender Wirth: 437 Typ L1

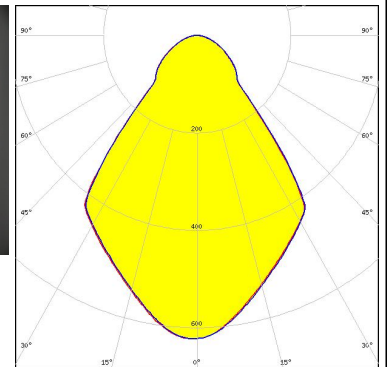
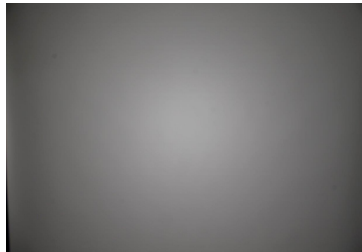

#### OSRAM

Opto Semiconductors

LED Soleriq S19  
 FWHM / FWTM 76.0° / 131.0°  
 Efficiency 93 %  
 Peak intensity 0.6 cd/lm  
 LEDs/each optic 1  
 Light colour White

Required components:

C13867\_LENASTD-BASE-VERO29  
 Bender Wirth: 462 Typ L3

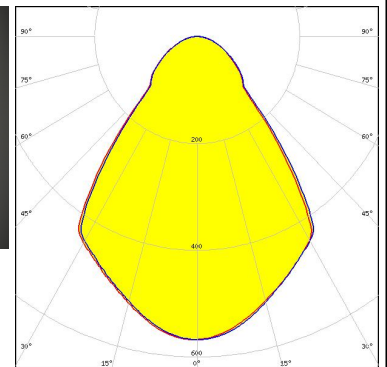
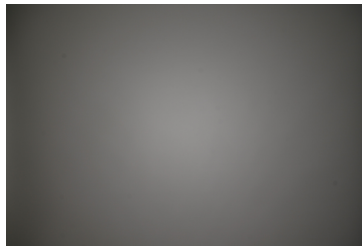

#### OSRAM

Opto Semiconductors

LED Soleriq S19  
 FWHM / FWTM 75.0° / 127.0°  
 Efficiency 88 %  
 Peak intensity 0.6 cd/lm  
 LEDs/each optic 1  
 Light colour White

Required components:

C13867\_LENASTD-BASE-VERO29  
 C12606\_LENINA-DL  
 Bender Wirth: 462 Typ L3

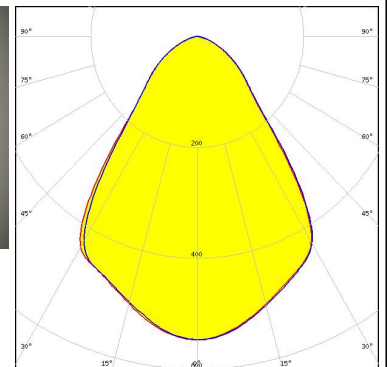

#### PHILIPS

LED Fortimo SLM L13 CoB  
 FWHM / FWTM 74.0° / 123.0°  
 Efficiency 94 %  
 Peak intensity 0.7 cd/lm  
 LEDs/each optic 1  
 Light colour White

Required components:

C12292\_LENASTD-BASE-MEZ

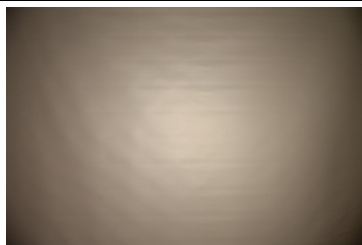



#### OPTICAL RESULTS (MEASURED):

### PHILIPS

LED Fortimo SLM L13 CoB  
 FWHM / FWTM 71.0° / 122.0°  
 Efficiency 88 %  
 Peak intensity 0.6 cd/lm  
 LEDs/each optic 1  
 Light colour White  
 Required components:  
 C12292\_LENASTD-BASE-MEZ  
 C12606\_LENINA-DL

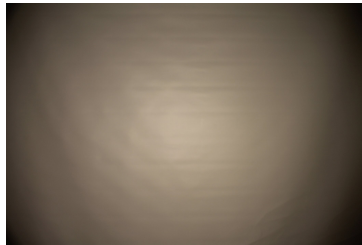

### PHILIPS

LED Fortimo SLM L15 CoB  
 FWHM / FWTM 72.0° / 123.0°  
 Efficiency 88 %  
 Peak intensity 0.6 cd/lm  
 LEDs/each optic 1  
 Light colour White  
 Required components:  
 C12292\_LENASTD-BASE-MEZ  
 C12606\_LENINA-DL

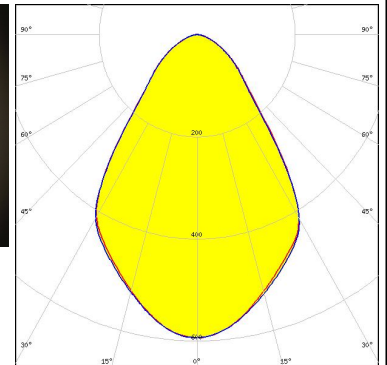
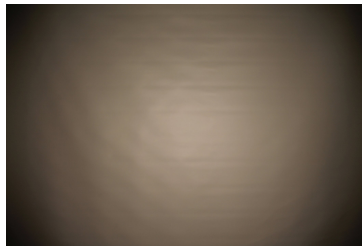

### PHILIPS

LED Fortimo SLM L15 CoB  
 FWHM / FWTM 73.0° / 123.0°  
 Efficiency 93 %  
 Peak intensity 0.7 cd/lm  
 LEDs/each optic 1  
 Light colour White  
 Required components:  
 C12292\_LENASTD-BASE-MEZ

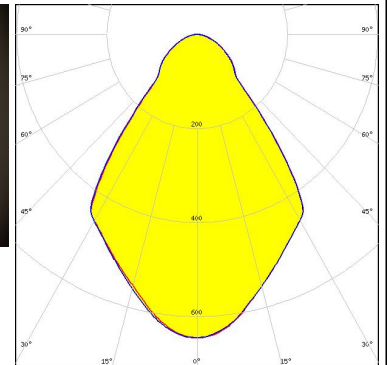
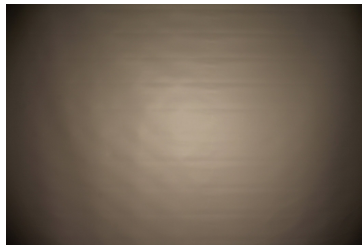

### PHILIPS

LED Fortimo SLM L19 CoB  
 FWHM / FWTM 72.0° / 122.0°  
 Efficiency 94 %  
 Peak intensity 0.7 cd/lm  
 LEDs/each optic 1  
 Light colour White  
 Required components:  
 C12692\_LENASTD-BASE-CLL040

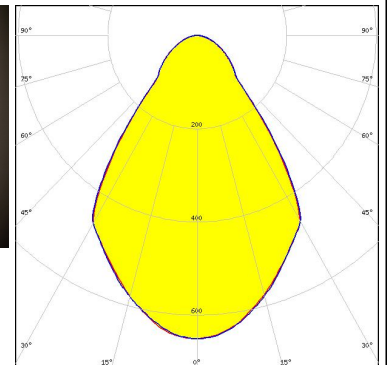
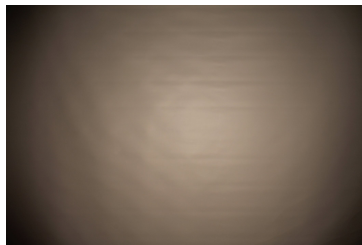

#### OPTICAL RESULTS (MEASURED):

### PHILIPS

LED Fortimo SLM L19 CoB  
 FWHM / FWTM 71.0° / 122.0°  
 Efficiency 88 %  
 Peak intensity 0.6 cd/lm  
 LEDs/each optic 1  
 Light colour White  
 Required components:  
 C12692\_LENINA-STD-BASE-CLL040  
 C12606\_LENINA-DL

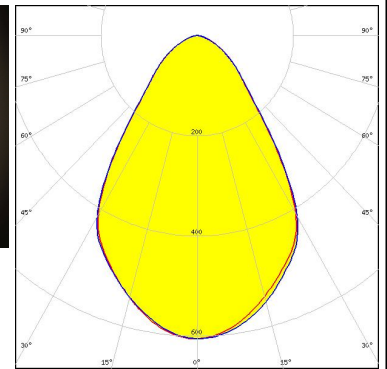
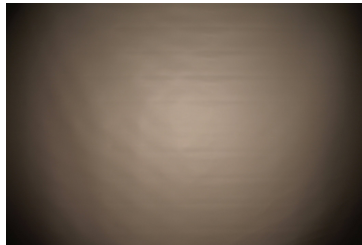

### PHILIPS

LED Fortimo SLM L23 CoB  
 FWHM / FWTM 71.0° / 122.0°  
 Efficiency 88 %  
 Peak intensity 0.6 cd/lm  
 LEDs/each optic 1  
 Light colour White  
 Required components:  
 C12692\_LENINA-STD-BASE-CLL040  
 C12606\_LENINA-DL

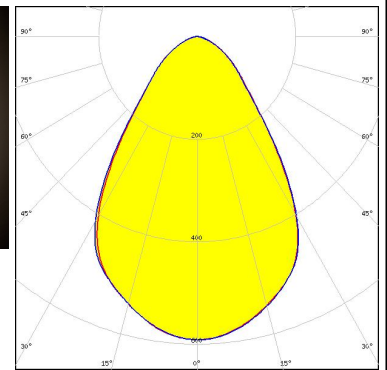
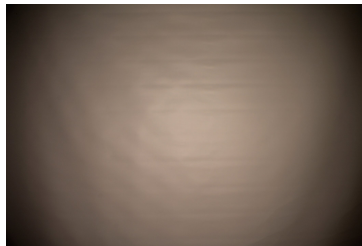

### PHILIPS

LED Fortimo SLM L23 CoB  
 FWHM / FWTM 72.0° / 122.0°  
 Efficiency 94 %  
 Peak intensity 0.6 cd/lm  
 LEDs/each optic 1  
 Light colour White  
 Required components:  
 C12692\_LENINA-STD-BASE-CLL040

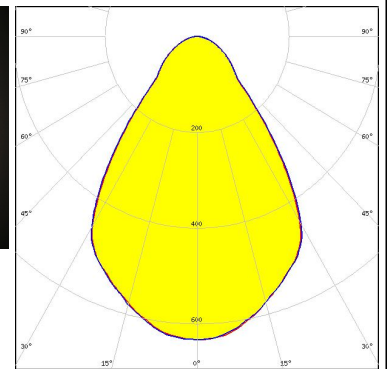
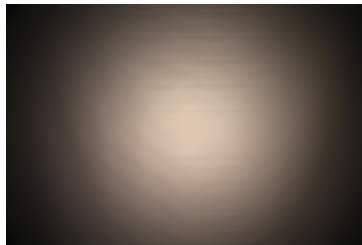

### SAMSUNG

LED LC016D / LC019D / LC026D / LC033D  
 FWHM / FWTM 74.0° / 125.0°  
 Efficiency 94 %  
 Peak intensity 0.6 cd/lm  
 LEDs/each optic 1  
 Light colour White  
 Required components:  
 C12691\_LENINA-STD-BASE-CLL030

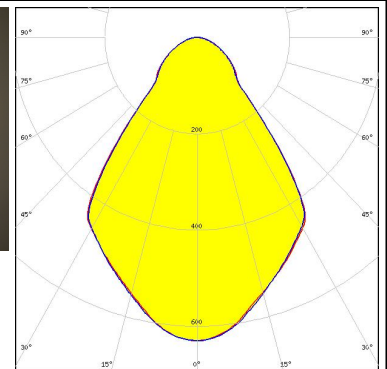
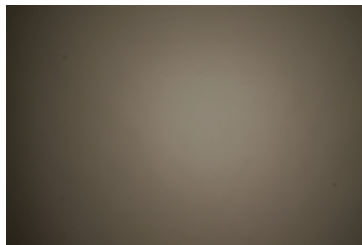



#### OPTICAL RESULTS (MEASURED):

### SAMSUNG

LED LC016D / LC019D / LC026D / LC033D  
 FWHM / FWTM 73.0° / 125.0°  
 Efficiency 89 %  
 Peak intensity 0.6 cd/m  
 LEDs/each optic 1  
 Light colour White  
 Required components:  
 C12691\_LENINA-STD-BASE-CLL030  
 C12606\_LENINA-DL

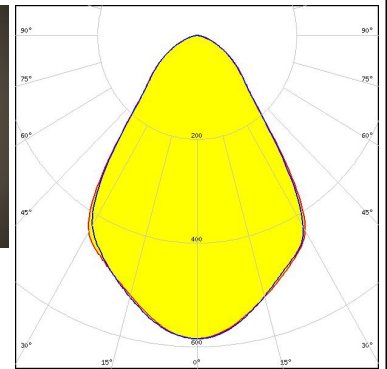
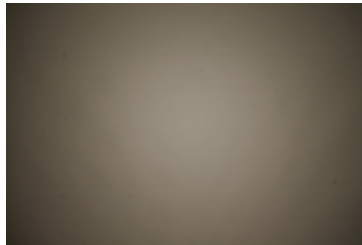

### SAMSUNG

LED LC026B / 033B / 040B  
 FWHM / FWTM 74.0° / 126.0°  
 Efficiency 90 %  
 Peak intensity 0.6 cd/m  
 LEDs/each optic 1  
 Light colour White  
 Required components:  
 C13868\_LENINA-STD-BASE-VERO13-18  
 C12606\_LENINA-DL  
 Bender Wirth: 450 Typ L2

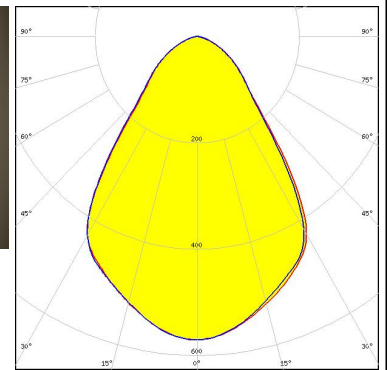
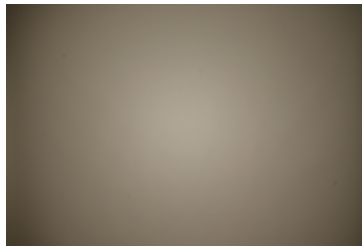

### SAMSUNG

LED LC026B / 033B / 040B  
 FWHM / FWTM 75.0° / 126.0°  
 Efficiency 94 %  
 Peak intensity 0.6 cd/m  
 LEDs/each optic 1  
 Light colour White  
 Required components:  
 C13868\_LENINA-STD-BASE-VERO13-18  
 Bender Wirth: 450 Typ L2

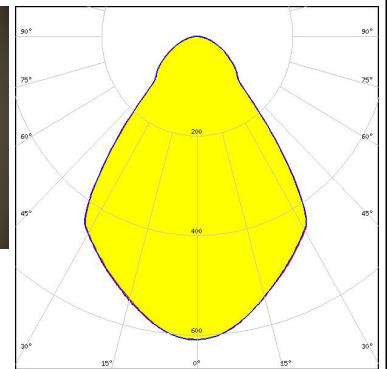
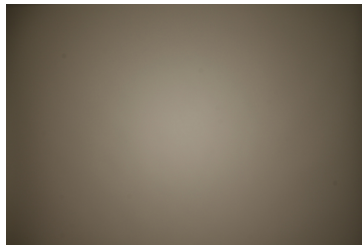



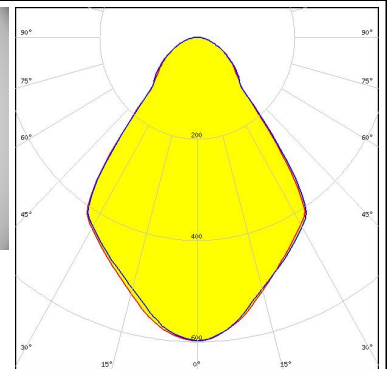
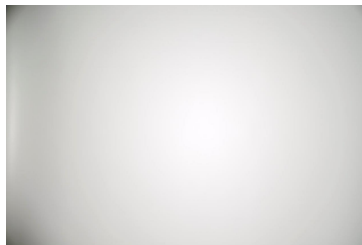

SEOUL SEMICONDUCTOR

LED ZC12/18  
 FWHM / FWTM 75.0° / 126.0°  
 Efficiency 90 %  
 Peak intensity 0.6 cd/m  
 LEDs/each optic 1  
 Light colour White  
 Required components:  
 C12691\_LENINA-STD-BASE-CLL030

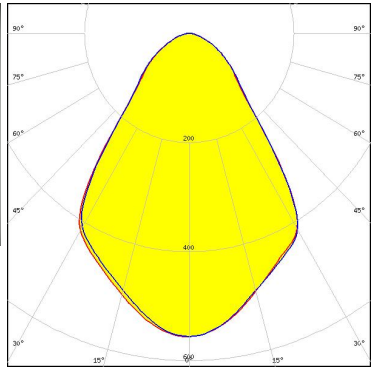
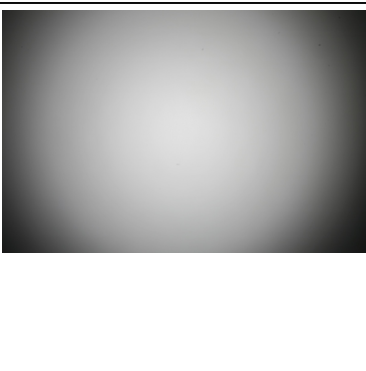
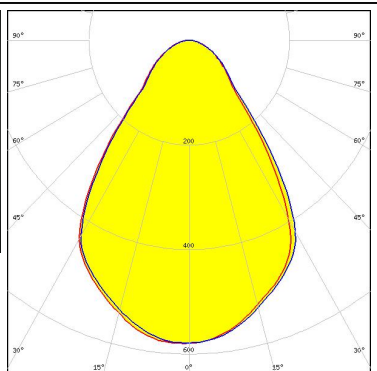

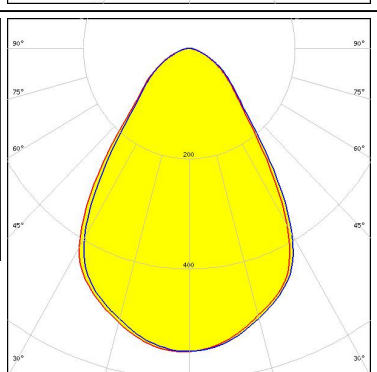
#### OPTICAL RESULTS (MEASURED):

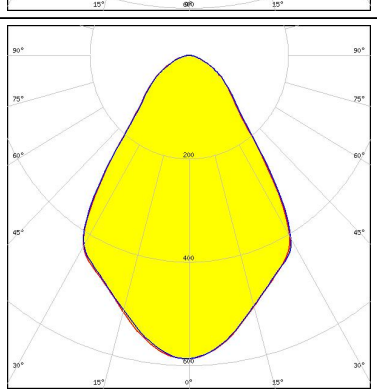
<p><b>SEOUL SEMICONDUCTOR</b></p> <p>LED ZC12/18            FWHM / FWTM 73.0° / 126.0°            Efficiency 86 %            Peak intensity 0.6 cd/m            LEDs/each optic 1            Light colour White</p> <p>Required components:            C12691_LENINA-STD-BASE-CLL030            C12606_LENINA-DL</p>		
<p><b>SEOUL SEMICONDUCTOR</b></p> <p>LED ZC25/40/60            FWHM / FWTM 73.0° / 125.0°            Efficiency 89 %            Peak intensity 0.6 cd/m            LEDs/each optic 1            Light colour White</p> <p>Required components:            C12692_LENINA-STD-BASE-CLL040</p>		
<p><b>SEOUL SEMICONDUCTOR</b></p> <p>LED ZC25/40/60            FWHM / FWTM 72.0° / 125.0°            Efficiency 85 %            Peak intensity 0.6 cd/m            LEDs/each optic 1            Light colour White</p> <p>Required components:            C12692_LENINA-STD-BASE-CLL040            C12606_LENINA-DL</p>		
<p><b>SHARP</b></p> <p>LED Mega Zenigata (GW5DGC)            FWHM / FWTM 72.0° / 124.0°            Efficiency 86 %            Peak intensity 0.6 cd/m            LEDs/each optic 1            Light colour White</p> <p>Required components:            C12292_LENINA-STD-BASE-MEZ            C12606_LENINA-DL</p>		

#### OPTICAL RESULTS (MEASURED):

### SHARP

LED Mega Zenigata (GW5DGC)  
 FWHM / FWTM 73.0° / 123.0°  
 Efficiency 90 %  
 Peak intensity 0.6 cd/lm  
 LEDs/each optic 1  
 Light colour White  
 Required components:  
 C12292\_LENINA-STD-BASE-MEZ

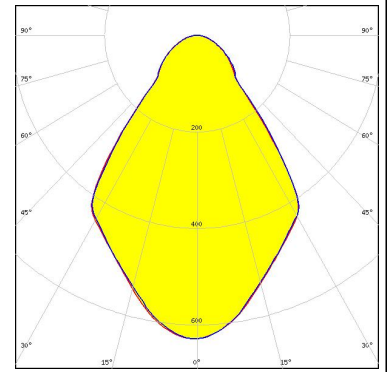

### SHARP

LED Mega Zenigata (GW6DME)  
 FWHM / FWTM 72.0° / 124.0°  
 Efficiency 85 %  
 Peak intensity 0.6 cd/lm  
 LEDs/each optic 1  
 Light colour White  
 Required components:  
 C12292\_LENINA-STD-BASE-MEZ  
 C12606\_LENINA-DL

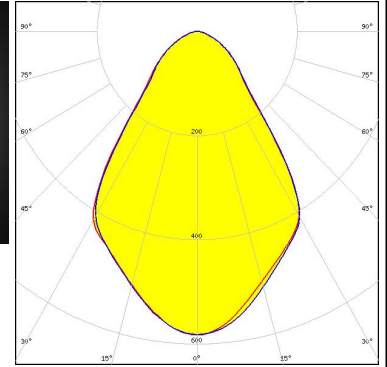
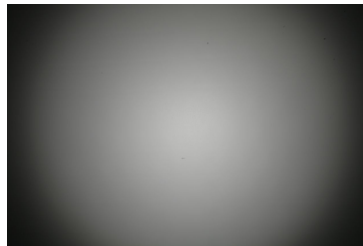

### SHARP

LED Mega Zenigata (GW6DME)  
 FWHM / FWTM 73.0° / 123.0°  
 Efficiency 89 %  
 Peak intensity 0.6 cd/lm  
 LEDs/each optic 1  
 Light colour White  
 Required components:  
 C12292\_LENINA-STD-BASE-MEZ

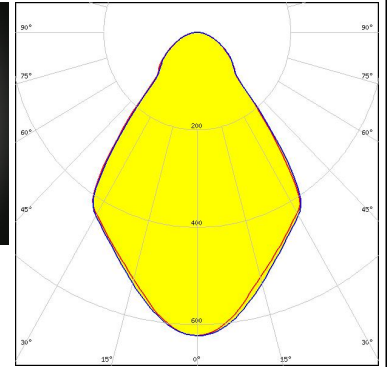
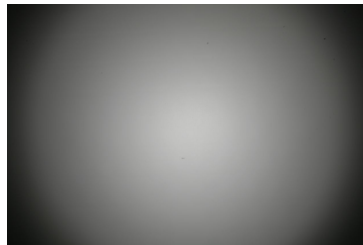

### TRIDONIC

LED SLE G7 LES15  
 FWHM / FWTM 73.0° / 125.0°  
 Efficiency 90 %  
 Peak intensity 0.6 cd/lm  
 LEDs/each optic 1  
 Light colour White  
 Required components:  
 C12691\_LENINA-STD-BASE-CLL030

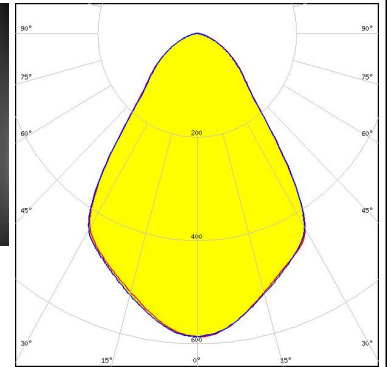
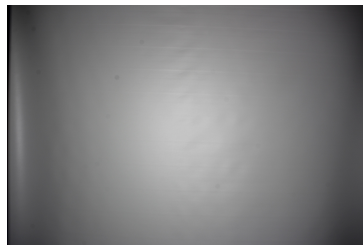

#### OPTICAL RESULTS (MEASURED):

#### TRIDONIC

LED SLE G7 LES17 H  
 FWHM / FWTM 74.0° / 126.0°  
 Efficiency 89 %  
 Peak intensity 0.6 cd/lm  
 LEDs/each optic 1  
 Light colour White  
 Required components:  
 C14547\_LENINA-ADAPTER-B

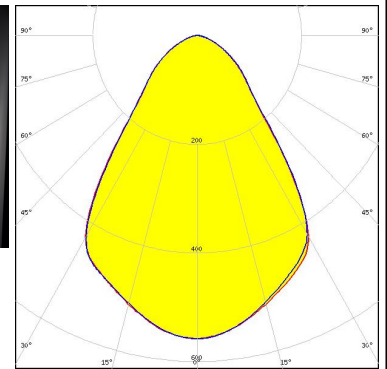
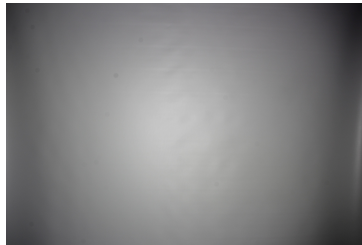

#### TRIDONIC

LED SLE G7 LES21 H  
 FWHM / FWTM 74.0° / 127.0°  
 Efficiency 93 %  
 Peak intensity 0.6 cd/lm  
 LEDs/each optic 1  
 Light colour White  
 Required components:  
 C14547\_LENINA-ADAPTER-B

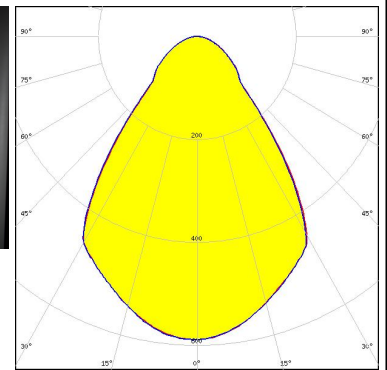
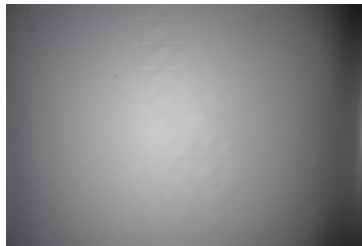



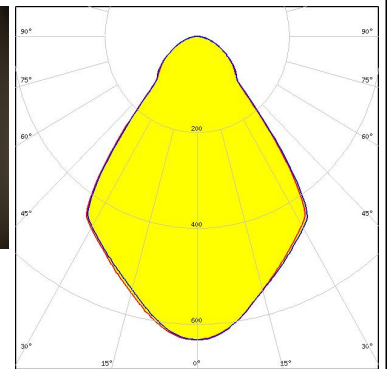
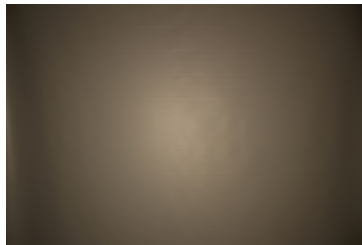

#### XICATO

LED XOB 14.5 mm  
 FWHM / FWTM 74.0° / 124.0°  
 Efficiency 94 %  
 Peak intensity 0.6 cd/lm  
 LEDs/each optic 1  
 Light colour White  
 Required components:  
 C12691\_LENINA-STD-BASE-CLL030

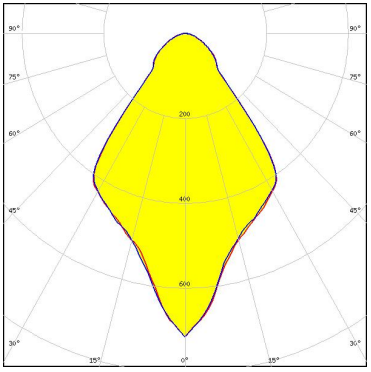

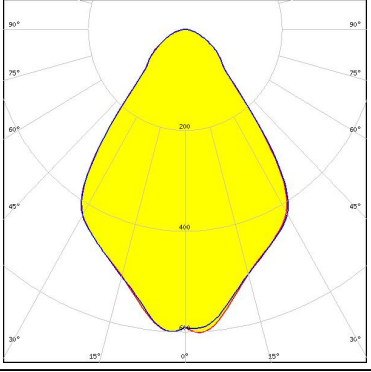
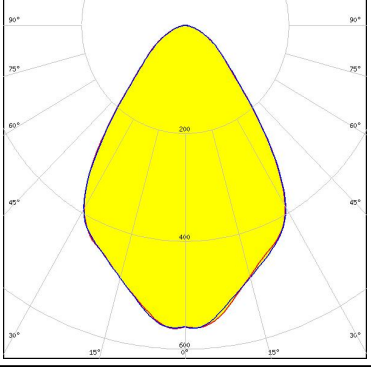



#### OPTICAL RESULTS (SIMULATED):

<p></p> <p>LED V10 Gen7            FWHM / FWTM 71.0° / 115.0°            Efficiency 86 %            Peak intensity 0.7 cd/lm            LEDs/each optic 1            Light colour White            Required components:            C13868_LENASTD-BASE-VERO13-18            Bender Wirth: 486 Typ L1</p>	
<p></p> <p>LED V13 Gen7            FWHM / FWTM 73.0° / 121.0°            Efficiency 86 %            Peak intensity 0.6 cd/lm            LEDs/each optic 1            Light colour White            Required components:            C13868_LENASTD-BASE-VERO13-18            Bender Wirth: 477 Typ L1</p>	
<p></p> <p>LED V13 Gen7            FWHM / FWTM 72.0° / 121.0°            Efficiency 82 %            Peak intensity 0.6 cd/lm            LEDs/each optic 1            Light colour White            Required components:            C13868_LENASTD-BASE-VERO13-18            C12606_LENINA-DL            Bender Wirth: 477 Typ L1</p>	
<p></p> <p>LED V13 Gen7            FWHM / FWTM 70.0° / 119.0°            Efficiency 83 %            Peak intensity 0.6 cd/lm            LEDs/each optic 1            Light colour White            Required components:            C12606_LENINA-DL            IDEAL: 50-2103CT + 50-2100AN</p>	

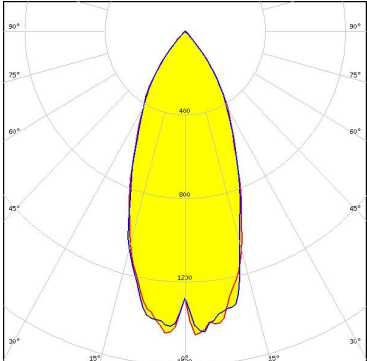

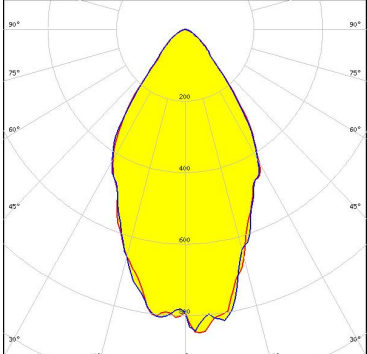
#### OPTICAL RESULTS (SIMULATED):

<p></p> <p>LED V22 Gen7            FWHM / FWTM 60.0° / 94.0°            Efficiency 89 %            LEDs/each optic 1            Light colour White            Required components:            C13867_LENINA-STD-BASE-VERO29            Bender Wirth: 431 Typ L3</p>	
<p></p> <p>LED V22 Gen7            FWHM / FWTM 60.0° / 96.0°            Efficiency 85 %            Peak intensity 0.9 cd/lm            LEDs/each optic 1            Light colour White            Required components:            C13867_LENINA-STD-BASE-VERO29            C12606_LENINA-DL            Bender Wirth: 431 Typ L3</p>	
<p></p> <p>LED CxM-14 (19x19)            FWHM / FWTM 75.0° / 126.0°            Efficiency 94 %            Peak intensity 0.6 cd/lm            LEDs/each optic 1            Light colour White            Required components:            C13868_LENINA-STD-BASE-VERO13-18            Bender Wirth: 433 Typ L1</p>	
<p></p> <p>LED CxM-14 (19x19)            FWHM / FWTM 74.0° / 125.0°            Efficiency 89 %            Peak intensity 0.6 cd/lm            LEDs/each optic 1            Light colour White            Required components:            C13868_LENINA-STD-BASE-VERO13-18            C12606_LENINA-DL            Bender Wirth: 433 Typ L1</p>	

#### OPTICAL RESULTS (SIMULATED):



LED CxM-9 (13.5x13.5)  
FWHM / FWTM 73.0° / 125.0°  
Efficiency 89 %  
Peak intensity 0.6 cd/lm  
LEDs/each optic 1  
Light colour White  
Required components:  
C13868\_LENINA-STD-BASE-VERO13-18  
C12606\_LENINA-DL  
Bender Wirth: 434 Typ L1



LED Soleriq S15  
FWHM / FWTM 72.0° / 119.0°  
Efficiency 87 %  
Peak intensity 0.7 cd/lm  
LEDs/each optic 1  
Light colour White  
Required components:  
C12691\_LENINA-STD-BASE-CLL030

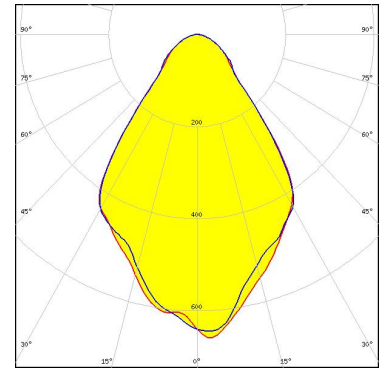

SEOUL SEMICONDUCTOR

LED ZC12/18  
FWHM / FWTM 75.0° / 126.0°  
Efficiency 94 %  
Peak intensity 0.6 cd/lm  
LEDs/each optic 1  
Light colour White  
Required components:  
C13868\_LENINA-STD-BASE-VERO13-18  
Bender Wirth: 433 Typ L1



SEOUL SEMICONDUCTOR

LED ZC12/18  
FWHM / FWTM 74.0° / 125.0°  
Efficiency 89 %  
Peak intensity 0.6 cd/lm  
LEDs/each optic 1  
Light colour White  
Required components:  
C13868\_LENINA-STD-BASE-VERO13-18  
C12606\_LENINA-DL  
Bender Wirth: 433 Typ L1

## OPTICAL RESULTS (SIMULATED):

 SEOL SEMICONDUCTOR	
LED	ZC4/6
FWHM / FWTM	73.0° / 125.0°
Efficiency	89 %
Peak intensity	0.6 cd/lm
LEDs/each optic	1
Light colour	White
Required components:	
C13868_LENINA-STD-BASE-VERO13-18	
C12606_LENINA-DL	
Bender Wirth: 434 Typ L1	

### GENERAL INFORMATION:

NOTE: The typical beam angle will be changed by different color, chip size and chip position tolerance. The typical total beam angle is the full angle measured where the luminous intensity is half of the peak value.

Due to use of high power COB's with this product, special attention to proper thermal design is highly recommended. LEDiL has no liability for direct, indirect or consecutive damages arising from the LEDiL products being used outside of the recommended temperature range.

### MATERIALS:

As part of our continuous research and improvement processes, and to ensure the best possible quality and availability of our products, LEDiL reserves the right to change material grades without notice.

### PRODUCT DATA USER AGREEMENT AND DISCLAIMER:

The measured data in the provided downloadable LEDiL Product Datasheets and Mechanical 2D-Drawings is rounded and provided as reference for planning. LEDiL Oy's optical specifications have been verified by conducting performance testing of the products in accordance with the company's quality system. The reported data are averaged results of multiple measurements with typical variation. LEDiL Oy reserves the right to without prior notification make changes and improvements to its products.

LEDiL Oy assumes neither warranty, nor guarantee nor any other liability of any kind for the contents and correctness of the provided data. The provided data has been generated with highest diligence but the provided data may in reality not represent the complete possible variation range of all intrinsic parameters. Therefore, in certain cases a deviation from the provided data could occur.

LEDiL Oy reserves the right to undertake technical changes of its products without further notification which could lead to changes in the provided data. LEDiL Oy assumes no liability of any kind for the possible deviation from any provided data or any other damage resulting from the usage of the provided data.

The user agrees to this disclaimer and user agreement with the download or usage of the provided files.

#### LEDiL Oy

Joensuunkatu 13  
FI-24240 SALO  
Finland

#### LEDiL Inc.

228 West Page Street  
Suite D  
Sycamore IL 60178  
USA

#### Ledil Optics Technology (Shenzhen) Co., Ltd.

# 405 , Block B  
Casic Motor Building  
Shenzhen 518057  
P.R.CHINA

#### Local sales and technical support

[www.ledil.com/  
where\\_to\\_buy](http://www.ledil.com/where_to_buy)

#### Shipping locations

Salo, Finland  
Hong Kong, China

#### Distribution Partners

[www.ledil.com/  
where\\_to\\_buy](http://www.ledil.com/where_to_buy)