

Mini Horns Sirens Buzzer / Buzzer 127
Buzzer BM Contin/pulse 230VAC BK



Part No.: 127.000.68



MECHANICAL DATA	
Length	91 mm
Width	89 mm
Height	64 mm
Diameter	89 mm
Materials	PC
Housing colour	Black
Protection category	IP65
Connection	Screw terminals
cross-sectional area maximum	1,50mm ² / 16AWG
Cable entry	Membrane grommet
Cable entry minimum	d = 1 mm
Cable entry maximum	d = 9 mm
Tension relief	Pull-out protection
Type of fixing	Base mounting
Working temperature minimum	-20°C
Working temperature maximum	+50°C
Weight with packaging	120 g
Product weight	86 g
ELECTRICAL DATA	
Operating voltage	230V
Operating voltage type	AC
Operating voltage frequency	50Hz
Operating voltage tolerance	+/- 10%
Rated operational voltage	230 VAC
Rated operational current	25 mA
Rated inrush current	500 mA
Protection class	Protection class 2
Pollution degree	3
Overvoltage category	II
Isolation voltage	U _i = 250V; U _{imp} = 2.500V
ACUSTICAL DATA	
Volume/dB(max) at 1m distance	92,0 dB (A)
Acoustic signal image	Continuous tone Pulse tone
Audio frequency	2300 Hz
Acoustic service life	5,000 h minimum

! For additional installation and mounting information, refer to the appropriate user guide at www.werma.com. This printed copy is for information only and is subject to alteration.

Mini Horns Sirens Buzzer / Buzzer 127

Buzzer BM Contin/pulse 230VAC BK

DRAWING

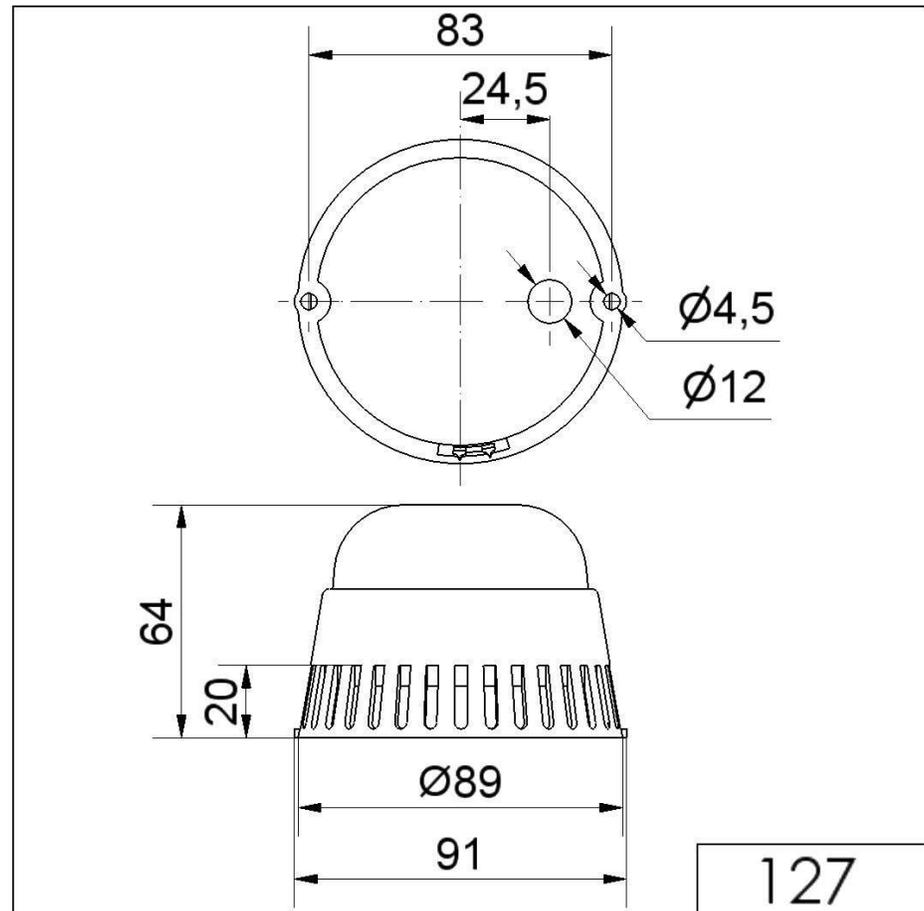

For additional installation and mounting information, refer to the appropriate user guide at www.werma.com. This printed copy is for information only and is subject to alteration.