

LENINA-W

~55° wide beam

SPECIFICATION:

Dimensions	Ø 74.0 mm
Height	40 mm
Fastening	socket
ROHS compliant	yes ⓘ

MATERIALS:

Component	Type	Material
LENINA-W	Reflector	PC



LEDiL

Colour	Finish	Coating
metal		lacquer

ORDERING INFORMATION:

Component

C12599_LENINA-W





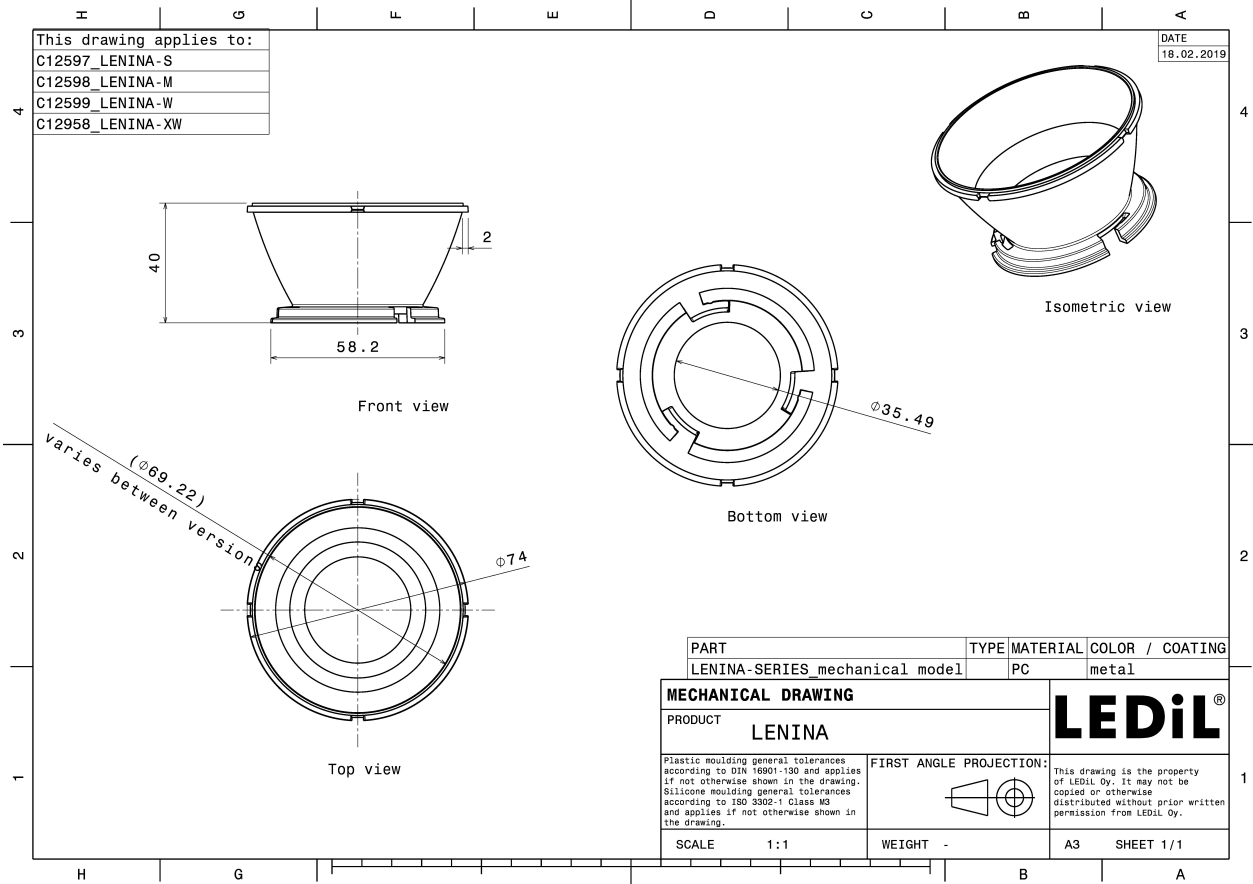



» Box size: 476 x 273 x 197 mm

Qty in box	MOQ	MPQ	Box weight (kg)
60	120	60	2.0

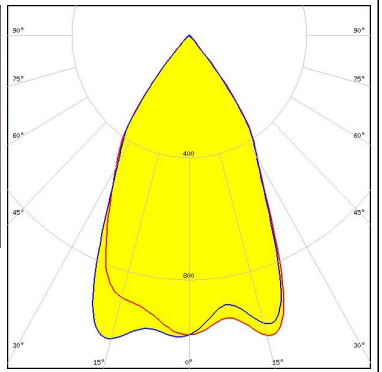

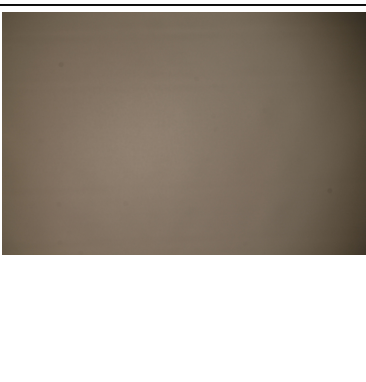
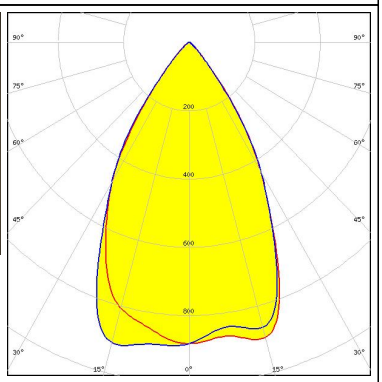

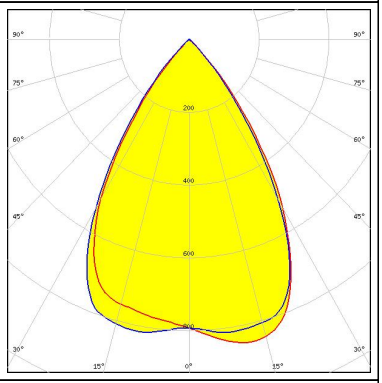
See also our general installation guide: www.ledil.com/installation_guide

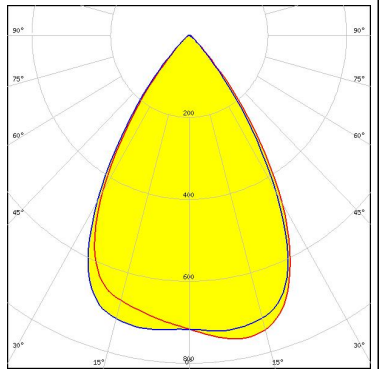



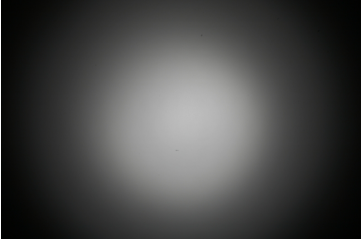

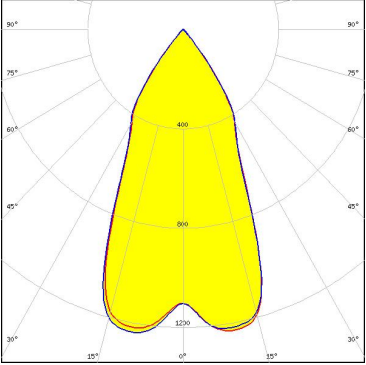
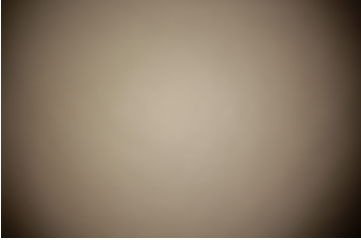
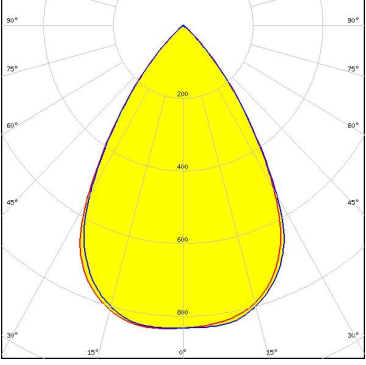
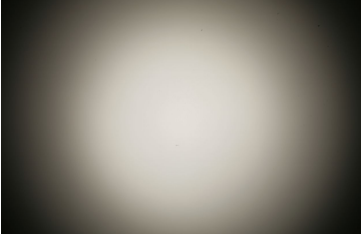
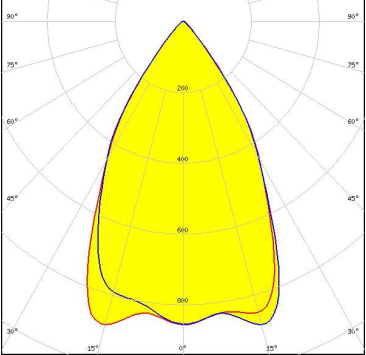
OPTICAL RESULTS (MEASURED):

<p></p> <p>LED BXRA ES Rectangle FWHM / FWTM 58.0° / 82.0° Efficiency 91 % Peak intensity 1.1 cd/lm LEDs/each optic 1 Light colour White Required components: C12153_LENASTD-BASE-BXRA</p>		
<p></p> <p>LED BXRA ES Rectangle FWHM / FWTM 60.0° / 84.0° Efficiency 86 % Peak intensity 0.9 cd/lm LEDs/each optic 1 Light colour White Required components: C12153_LENASTD-BASE-BXRA C12606_LENINA-DL</p>		
<p></p> <p>LED BXRA RS FWHM / FWTM 64.0° / 87.0° Efficiency 88 % Peak intensity 0.9 cd/lm LEDs/each optic 1 Light colour White Required components: C12229_LENASTD-BASE-RS</p>		
<p></p> <p>LED BXRA RS FWHM / FWTM 60.0° / 89.0° Efficiency 80 % Peak intensity 0.8 cd/lm LEDs/each optic 1 Light colour White Required components: C12229_LENASTD-BASE-RS C12606_LENINA-DL</p>		

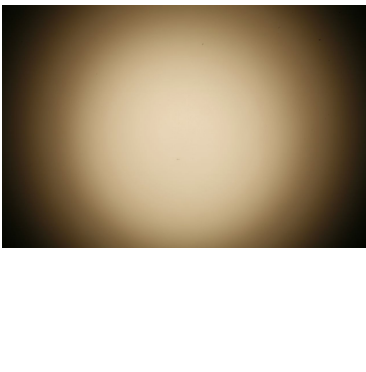
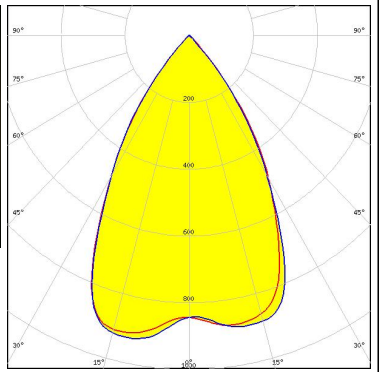
OPTICAL RESULTS (MEASURED):

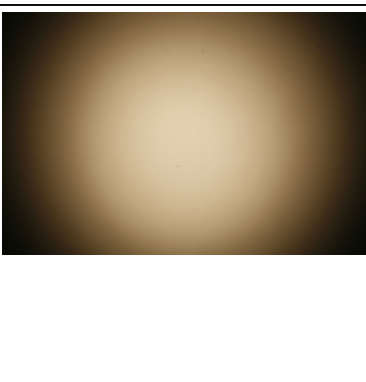
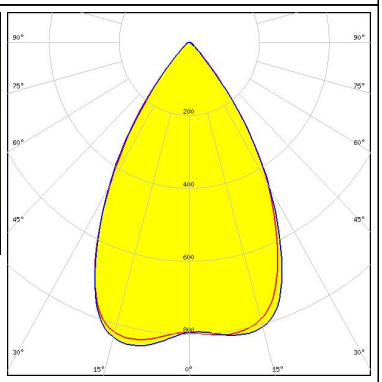
<p>bridgelux.</p> <p>LED V10 Gen6</p> <p>FWHM / FWTM 47.0° / 80.0°</p> <p>Efficiency 83 %</p> <p>Peak intensity 1.3 cd/m</p> <p>LEDs/each optic 1</p> <p>Light colour White</p> <p>Required components:</p> <p>C13186_LENINA-STD-BASE-CXA15</p> <p>C12606_LENINA-DL</p>		
<p>bridgelux.</p> <p>LED V4 HD Gen 7</p> <p>FWHM / FWTM 48.0° / 79.0°</p> <p>Efficiency 91 %</p> <p>Peak intensity 1.2 cd/m</p> <p>LEDs/each optic 1</p> <p>Light colour White</p> <p>Required components:</p> <p>C14146_LENINA-STD-BASE-CXA18</p>		
<p>bridgelux.</p> <p>LED Vero SE 29</p> <p>FWHM / FWTM 66.0° / 90.0°</p> <p>Efficiency 91 %</p> <p>Peak intensity 0.8 cd/m</p> <p>LEDs/each optic 1</p> <p>Light colour White</p> <p>Required components:</p> <p>C15083_LENINA-STD-BASE-VERO29</p>		
<p>bridgelux.</p> <p>LED VERO13</p> <p>FWHM / FWTM 60.0° / 84.0°</p> <p>Efficiency 85 %</p> <p>Peak intensity 0.9 cd/m</p> <p>LEDs/each optic 1</p> <p>Light colour White</p> <p>Required components:</p> <p>C13868_LENINA-STD-BASE-VERO13-18</p> <p>C12606_LENINA-DL</p>		

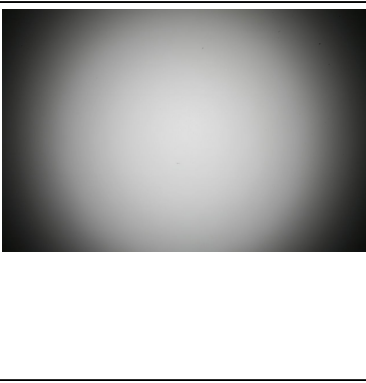
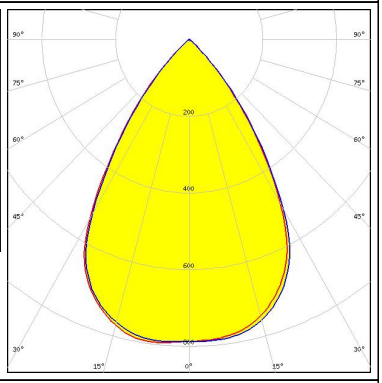
OPTICAL RESULTS (MEASURED):

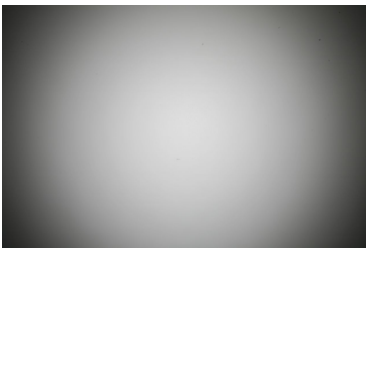
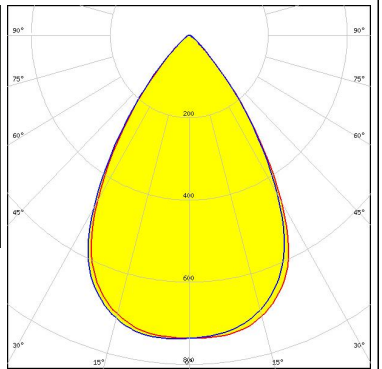
<p></p> <p>LED VERO18 FWHM / FWTM 64.0° / 85.0° Efficiency 89 % Peak intensity 0.9 cd/m LEDs/each optic 1 Light colour White Required components: C13868_LENINA-STD-BASE-VERO13-18</p>		
<p></p> <p>LED VERO18 FWHM / FWTM 64.0° / 86.0° Efficiency 85 % Peak intensity 0.9 cd/m LEDs/each optic 1 Light colour White Required components: C13868_LENINA-STD-BASE-VERO13-18 C12606_LENINA-DL</p>		
<p></p> <p>LED VERO29 FWHM / FWTM 67.0° / 91.0° Efficiency 88 % Peak intensity 0.8 cd/m LEDs/each optic 1 Light colour White Required components: C13867_LENINA-STD-BASE-VERO29</p>		
<p></p> <p>LED VERO29 FWHM / FWTM 67.0° / 92.0° Efficiency 84 % Peak intensity 0.7 cd/m LEDs/each optic 1 Light colour White Required components: C13867_LENINA-STD-BASE-VERO29 C12606_LENINA-DL</p>		

OPTICAL RESULTS (MEASURED):

CITIZEN

LED CL-L340
 FWHM / FWTM 53.0° / 81.0°
 Efficiency 91 %
 Peak intensity 1.1 cd/lm
 LEDs/each optic 1
 Light colour White
 Required components:
 C11995_LENINA-STD-BASE-CL340

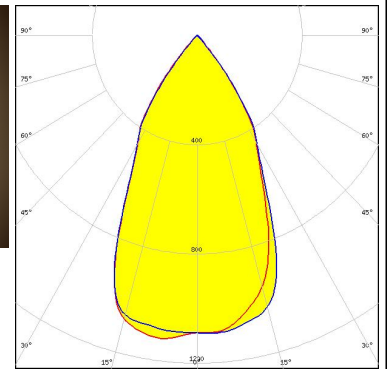
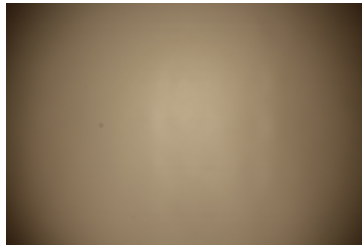

CITIZEN

LED CL-L340
 FWHM / FWTM 48.0° / 80.0°
 Efficiency 86 %
 LEDs/each optic 1
 Light colour White
 Required components:
 C11995_LENINA-STD-BASE-CL340

CITIZEN

LED CL-L340
 FWHM / FWTM 50.0° / 83.0°
 Efficiency 78 %
 LEDs/each optic 1
 Light colour White
 Required components:
 C11995_LENINA-STD-BASE-CL340
 C12606_LENINA-DL

CITIZEN

LED CLL02x/CLU02x (LES10)
 FWHM / FWTM 57.0° / 82.0°
 Efficiency 86 %
 Peak intensity 1 cd/lm
 LEDs/each optic 1
 Light colour White
 Required components:
 C13868_LENINA-STD-BASE-VERO13-18
 C12606_LENINA-DL
 Bender Wirth: 434 Typ L1

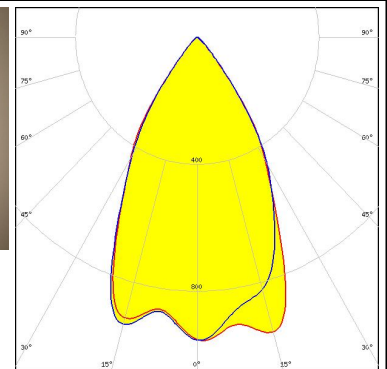
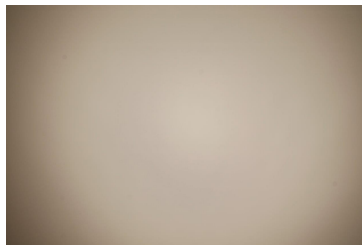

OPTICAL RESULTS (MEASURED):

CITIZEN

LED CLL03x/CLU03x
 FWHM / FWTM 58.0° / 84.0°
 Efficiency 86 %
 Peak intensity 1 cd/lm
 LEDs/each optic 1
 Light colour White
 Required components:
 C12691_LENINA-STD-BASE-CLL030
 C12606_LENINA-DL

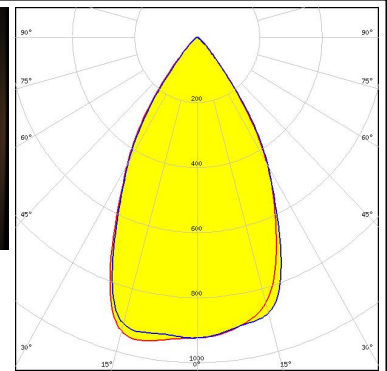
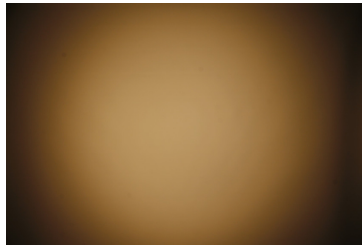

CITIZEN

LED CLL03x/CLU03x
 FWHM / FWTM 60.0° / 83.0°
 Efficiency 86 %
 Peak intensity 1 cd/lm
 LEDs/each optic 1
 Light colour White
 Required components:
 C13868_LENINA-STD-BASE-VERO13-18
 C12606_LENINA-DL
 Bender Wirth: 433 Typ L1

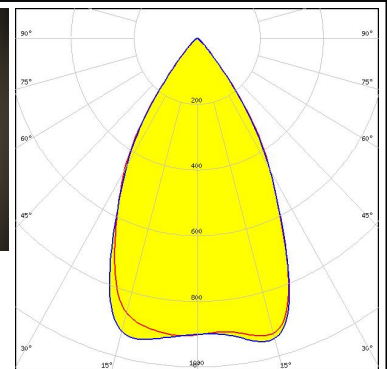
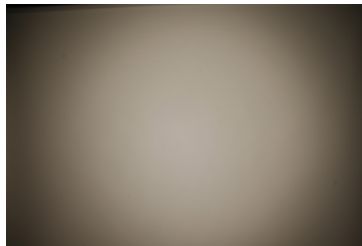

CITIZEN

LED CLL03x/CLU03x
 FWHM / FWTM 56.0° / 82.0°
 Efficiency 90 %
 Peak intensity 1.1 cd/lm
 LEDs/each optic 1
 Light colour White
 Required components:
 C12691_LENINA-STD-BASE-CLL030

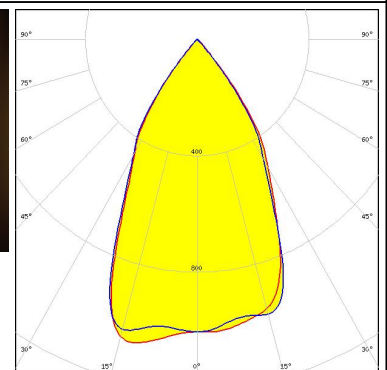
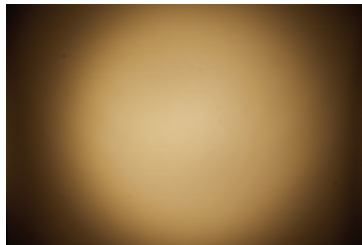

CITIZEN

LED CLL04x/CLU04x
 FWHM / FWTM 55.0° / 84.0°
 Efficiency 86 %
 Peak intensity 1 cd/lm
 LEDs/each optic 1
 Light colour White
 Required components:
 C12606_LENINA-DL
 IDEAL: 50-2204CT + 50-2100LN

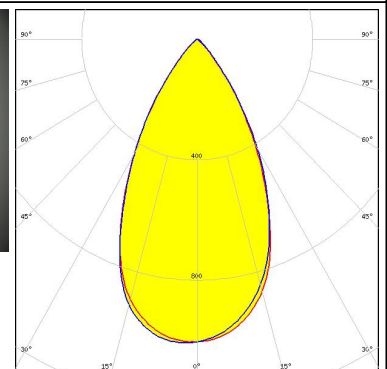

OPTICAL RESULTS (MEASURED):

CITIZEN

LED CLL04x/CLU04x
 FWHM / FWTM 61.0° / 87.0°
 Efficiency 86 %
 Peak intensity 0.9 cd/lm
 LEDs/each optic 1
 Light colour White
 Required components:
 C13867_LENINA-STD-BASE-VERO29
 C12606_LENINA-DL
 Bender Wirth: 431 Typ L3

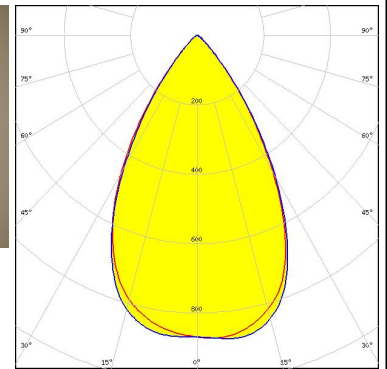
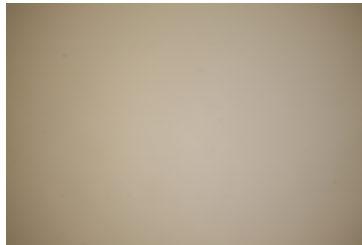

CITIZEN

LED CLL04x/CLU04x
 FWHM / FWTM 56.0° / 87.0°
 Efficiency 76 %
 Peak intensity 0.9 cd/lm
 LEDs/each optic 1
 Light colour White
 Required components:
 C12692_LENINA-STD-BASE-CLL040
 C12606_LENINA-DL

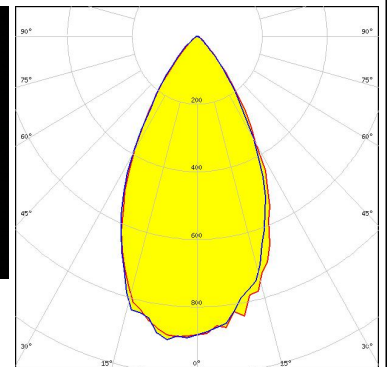
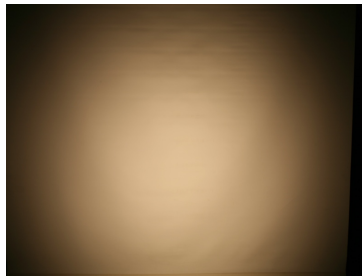

CITIZEN

LED CLL04x/CLU04x
 FWHM / FWTM 58.0° / 85.0°
 Efficiency 78 %
 Peak intensity 0.9 cd/lm
 LEDs/each optic 1
 Light colour White
 Required components:
 C12606_LENINA-DL
 A.A.G. STUCCHI: 8102-G2 + S-8000-12

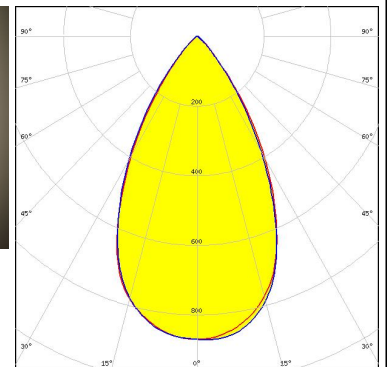
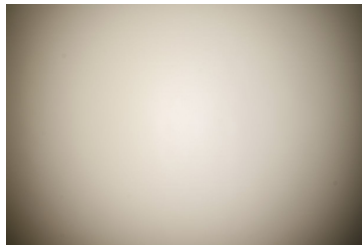

CITIZEN

LED CLL04x/CLU04x
 FWHM / FWTM 61.0° / 85.0°
 Efficiency 91 %
 Peak intensity 1 cd/lm
 LEDs/each optic 1
 Light colour White
 Required components:
 C13867_LENINA-STD-BASE-VERO29
 Bender Wirth: 431 Typ L3

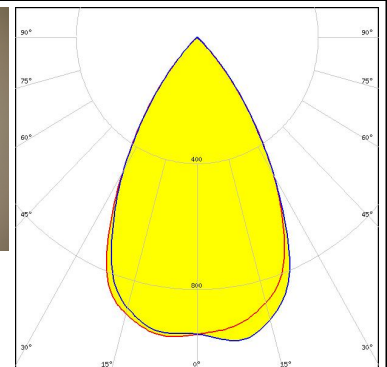
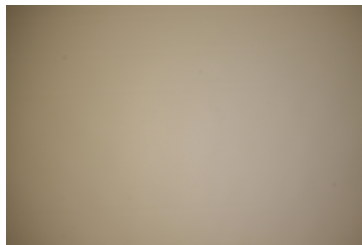

OPTICAL RESULTS (MEASURED):

CITIZEN

LED CLL04x/CLU04x
 FWHM / FWTM 54.0° / 83.0°
 Efficiency 87 %
 Peak intensity 1.1 cd/lm
 LEDs/each optic 1
 Light colour White
 Required components:
 IDEAL: 50-2204CT + 50-2100LN

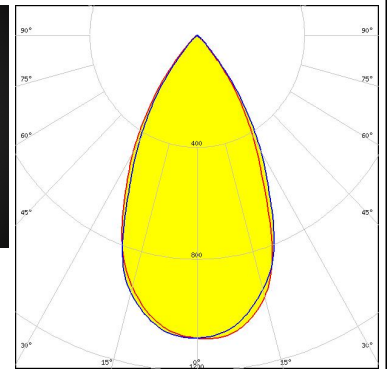
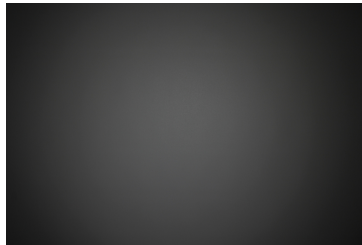

CITIZEN

LED CLL04x/CLU04x
 FWHM / FWTM 59.0° / 85.0°
 Efficiency 84 %
 Peak intensity 1 cd/lm
 LEDs/each optic 1
 Light colour White
 Required components:
 C12692_LENINA-STD-BASE-CLL040

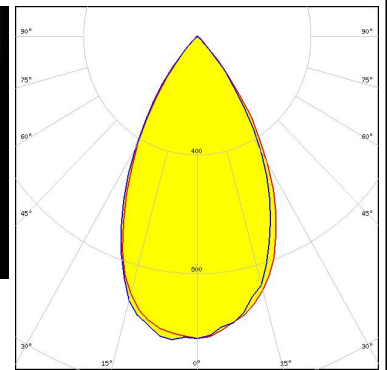
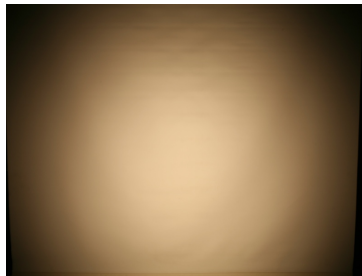

CITIZEN

LED CLL04x/CLU04x
 FWHM / FWTM 57.0° / 84.0°
 Efficiency 82 %
 Peak intensity 1 cd/lm
 LEDs/each optic 1
 Light colour White
 Required components:
 A.A.G. STUCCHI: 8102-G2 + S-8000-12

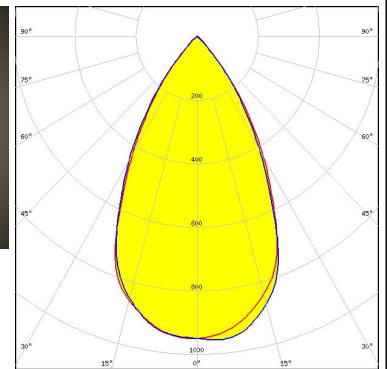
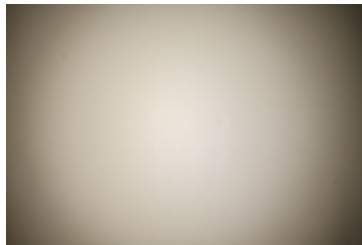

CITIZEN

LED CLU710/711
 FWHM / FWTM 55.0° / 82.0°
 Efficiency 89 %
 Peak intensity 1 cd/lm
 LEDs/each optic 1
 Light colour White
 Required components:
 C12691_LENINA-STD-BASE-CLL030
 C12606_LENINA-DL

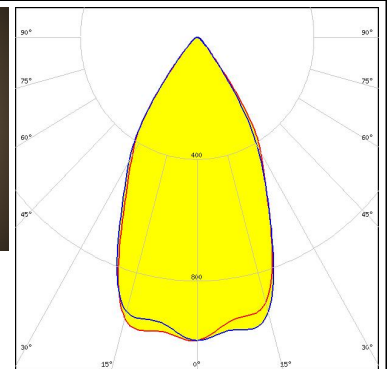
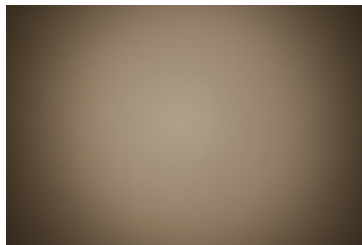

OPTICAL RESULTS (MEASURED):

CITIZEN

LED CLU720/721/723
 FWHM / FWTM 54.0° / 81.0°
 Efficiency 87 %
 Peak intensity 1 cd/lm
 LEDs/each optic 1
 Light colour White
 Required components:
 C12691_LENINA-STD-BASE-CLL030

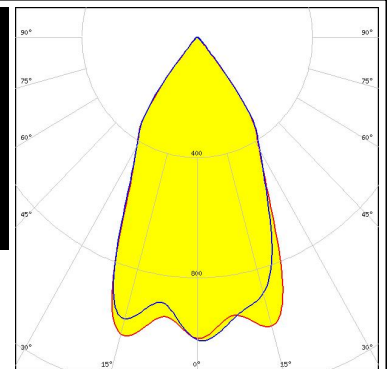
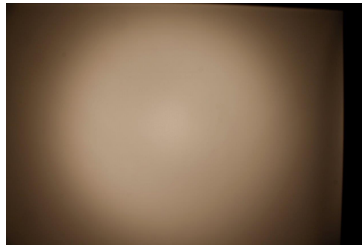

CITIZEN

LED CLU720/721/723
 FWHM / FWTM 57.0° / 83.0°
 Efficiency 83 %
 Peak intensity 0.9 cd/lm
 LEDs/each optic 1
 Light colour White
 Required components:
 C12691_LENINA-STD-BASE-CLL030
 C12606_LENINA-DL

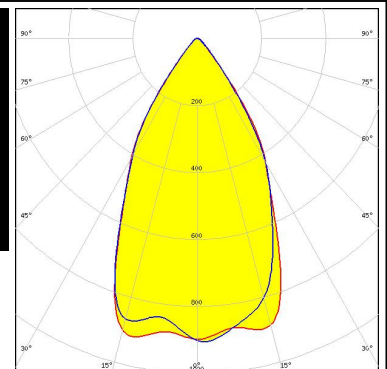
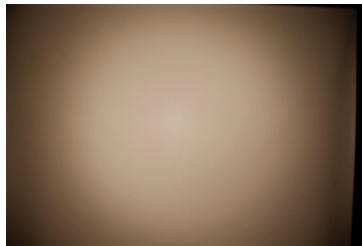

CITIZEN

LED CLU730/731/733
 FWHM / FWTM 50.0° / 82.0°
 Efficiency 83 %
 Peak intensity 1 cd/lm
 LEDs/each optic 1
 Light colour White
 Required components:
 C12692_LENINA-STD-BASE-CLL040
 C12606_LENINA-DL

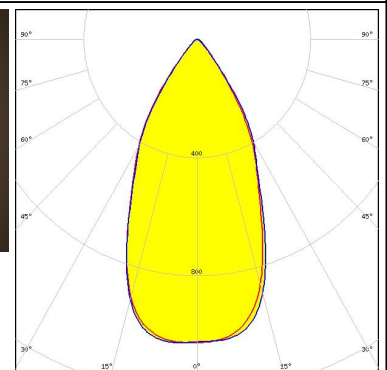
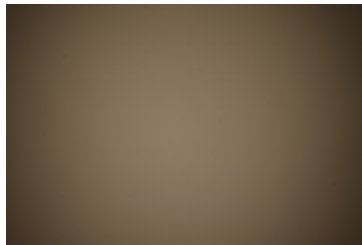



CITIZEN

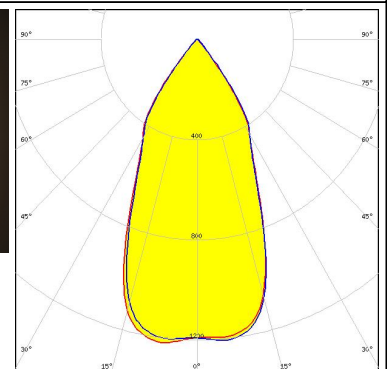
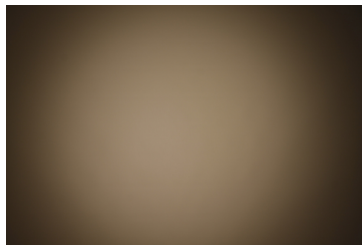

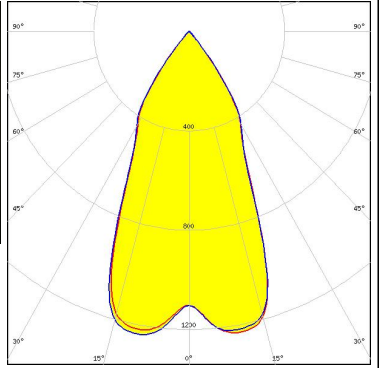

LED CLU730/731/733
 FWHM / FWTM 49.0° / 80.0°
 Efficiency 93 %
 Peak intensity 1.2 cd/lm
 LEDs/each optic 1
 Light colour White
 Required components:
 C12692_LENINA-STD-BASE-CLL040

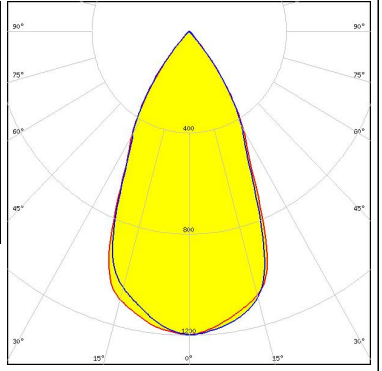
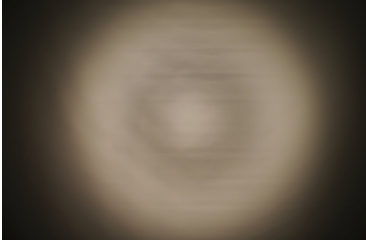
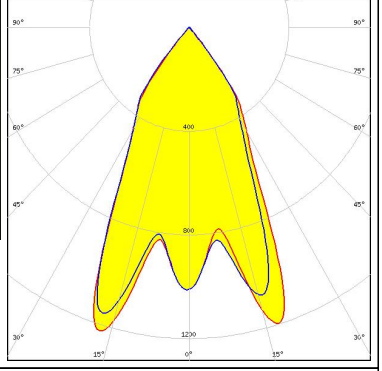
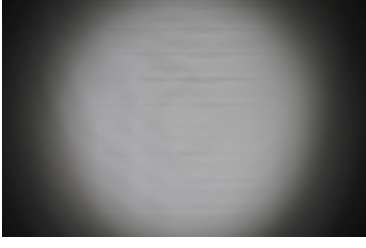
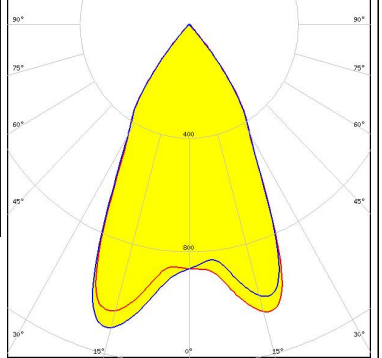

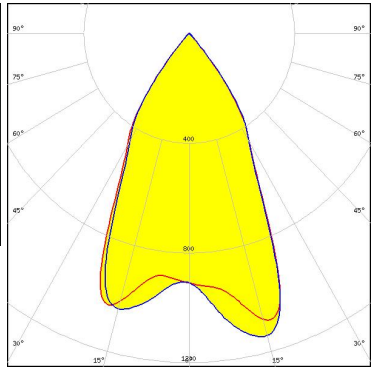

OPTICAL RESULTS (MEASURED):

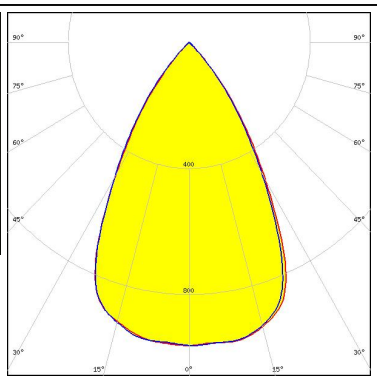
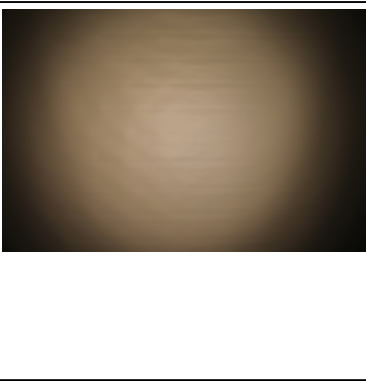
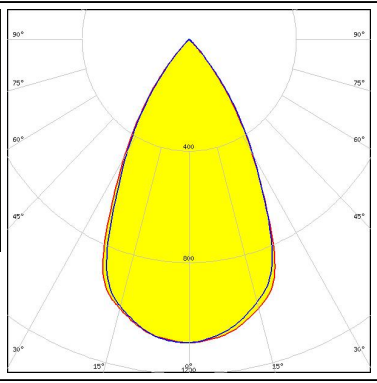
<p>CREE LEDs</p> <p>LED CMA1840 FWHM / FWTM 48.0° / 79.0° Efficiency 91 % Peak intensity 1.2 cd/lm LEDs/each optic 1 Light colour White Required components: C14146_LENASTD-BASE-CXA18</p>		
<p>CREE LEDs</p> <p>LED CMA2550 FWHM / FWTM 51.0° / 80.0° Efficiency 91 % Peak intensity 1.2 cd/lm LEDs/each optic 1 Light colour White Required components: C13324_LENASTD-BASE-CXA25</p>		
<p>CREE LEDs</p> <p>LED CMT14xx FWHM / FWTM 55.0° / 81.0° Efficiency 91 % Peak intensity 1.2 cd/lm LEDs/each optic 1 Light colour White Required components: C13868_LENASTD-BASE-VERO13-18 Bender Wirth: 434 Typ L1</p>		
<p>CREE LEDs</p> <p>LED CMT19xx FWHM / FWTM 55.0° / 82.0° Efficiency 91 % Peak intensity 1.1 cd/lm LEDs/each optic 1 Light colour White Required components: C13868_LENASTD-BASE-VERO13-18 Bender Wirth: 477 Typ L1</p>		

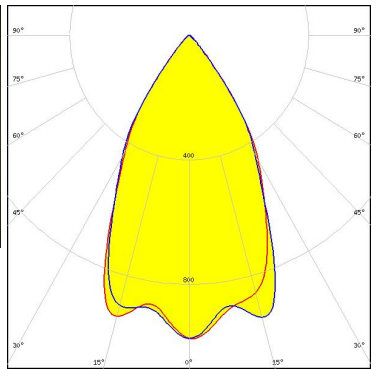
OPTICAL RESULTS (MEASURED):

<p>CREE LEDs</p> <p>LED CMT19xx FWHM / FWTM 54.0° / 81.0° Efficiency 91 % Peak intensity 1.1 cd/lm LEDs/each optic 1 Light colour White</p> <p>Required components: C12691_LENINA-STD-BASE-CLL030 Bender Wirth: 477 Typ L1</p>		
<p>CREE LEDs</p> <p>LED CMT28xx FWHM / FWTM 60.0° / 84.0° Efficiency 91 % Peak intensity 1 cd/lm LEDs/each optic 1 Light colour White</p> <p>Required components: C13867_LENINA-STD-BASE-VERO29 Bender Wirth: 471 Typ L3</p>		
<p>CREE LEDs</p> <p>LED CMT28xx FWHM / FWTM 56.0° / 82.0° Efficiency 92 % Peak intensity 1.1 cd/lm LEDs/each optic 1 Light colour White</p> <p>Required components: C12692_LENINA-STD-BASE-CLL040</p>		
<p>CREE LEDs</p> <p>LED CXA/B 15xx FWHM / FWTM 57.0° / 82.0° Efficiency 86 % Peak intensity 1 cd/lm LEDs/each optic 1 Light colour White</p> <p>Required components: C13868_LENINA-STD-BASE-VERO13-18 C12606_LENINA-DL Bender Wirth: 441 Typ L1</p>		

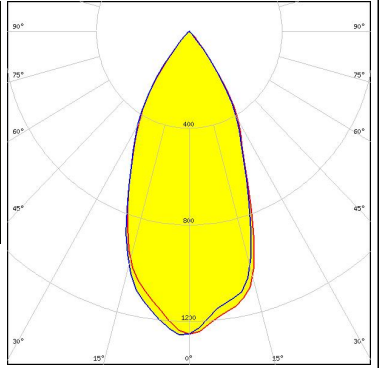
OPTICAL RESULTS (MEASURED):

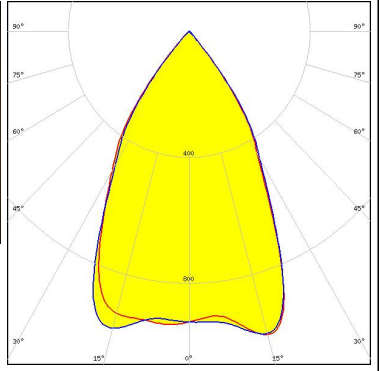
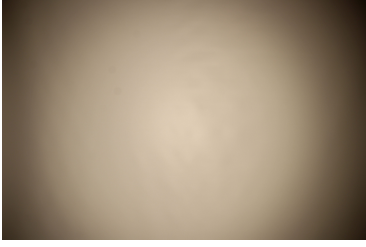
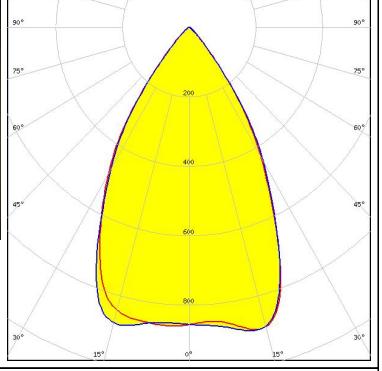
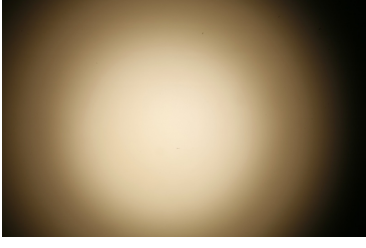
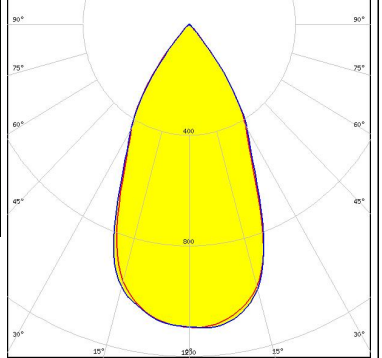
<p>CREE LEDs</p> <p>LED CXA/B 15xx FWHM / FWTM 48.0° / 79.0° Efficiency 83 % Peak intensity 1.3 cd/lm LEDs/each optic 1 Light colour White</p> <p>Required components: C13186_LENINA-STD-BASE-CXA15 C12606_LENINA-DL</p>		
<p>CREE LEDs</p> <p>LED CXA/B 1830 FWHM / FWTM 60.0° / 83.0° Efficiency 91 % Peak intensity 1 cd/lm LEDs/each optic 1 Light colour White</p> <p>Required components: C13868_LENINA-STD-BASE-VERO13-18 Bender Wirth: 437 Typ L1</p>		
<p>CREE LEDs</p> <p>LED CXA/B 1830 FWHM / FWTM 61.0° / 85.0° Efficiency 86 % Peak intensity 0.9 cd/lm LEDs/each optic 1 Light colour White</p> <p>Required components: C13868_LENINA-STD-BASE-VERO13-18 C12606_LENINA-DL Bender Wirth: 437 Typ L1</p>		
<p>CREE LEDs</p> <p>LED CXA/B 25xx FWHM / FWTM 51.0° / 80.0° Efficiency 84 % Peak intensity 1.2 cd/lm LEDs/each optic 1 Light colour White</p> <p>Required components: C13324_LENINA-STD-BASE-CXA25</p>		

OPTICAL RESULTS (MEASURED):



LED CXA/B 25xx
 FWHM / FWTM 52.0° / 80.0°
 Efficiency 76 %
 Peak intensity 1.1 cd/lm
 LEDs/each optic 1
 Light colour White
 Required components:
 C13324_LENINA-STD-BASE-CXA25
 C12606_LENINA-DL

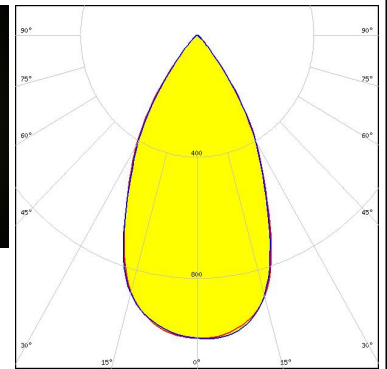
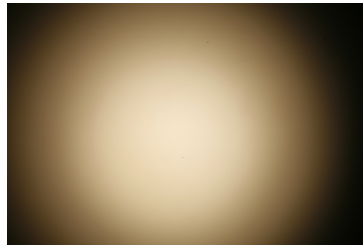

LED CXA2011
 FWHM / FWTM 50.0° / 80.0°
 Efficiency 86 %
 Peak intensity 1.2 cd/lm
 LEDs/each optic 1
 Light colour White
 Required components:
 C12105_LENINA-STD-BASE-CXA20

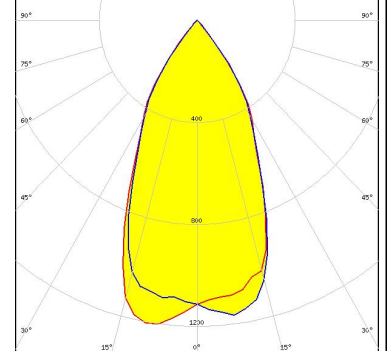

LED CXA2011
 FWHM / FWTM 52.0° / 83.0°
 Efficiency 78 %
 Peak intensity 1 cd/lm
 LEDs/each optic 1
 Light colour White
 Required components:
 C12105_LENINA-STD-BASE-CXA20
 C12606_LENINA-DL

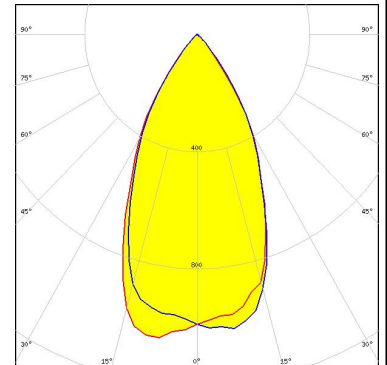

LED CHI3030 19W
 FWHM / FWTM 62.0° / 88.0°
 Efficiency 90 %
 Peak intensity 0.9 cd/lm
 LEDs/each optic 1
 Light colour White
 Required components:
 C13867_LENINA-STD-BASE-VERO29
 C12606_LENINA-DL
 Bender Wirth: 468 Typ L3

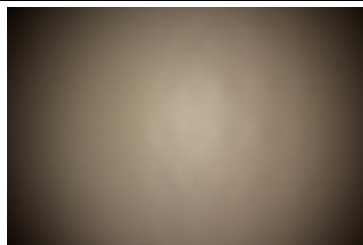

OPTICAL RESULTS (MEASURED):

EVERLIGHT

LED CHI3030 29W
 FWHM / FWTM 63.0° / 92.0°
 Efficiency 86 %
 Peak intensity 0.8 cd/lm
 LEDs/each optic 1
 Light colour White

Required components:

C13867_LENINA-STD-BASE-VERO29
 C12606_LENINA-DL
 Bender Wirth: 468 Typ L3

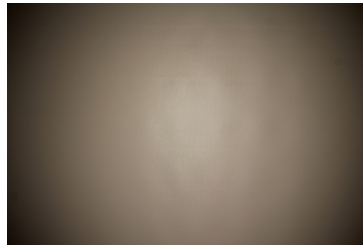

LUMILEDS

LED LUXEON CoB 1204/1205
 FWHM / FWTM 55.0° / 81.0°
 Efficiency 89 %
 Peak intensity 1.1 cd/lm
 LEDs/each optic 1
 Light colour White

Required components:

C12292_LENINA-STD-BASE-MEZ

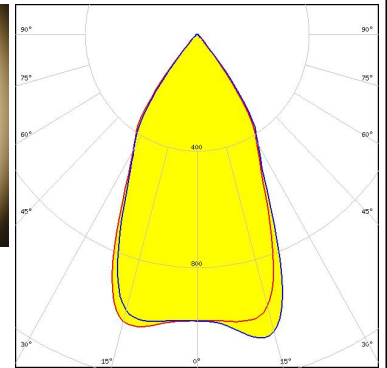

LUMILEDS

LED LUXEON CoB 1204/1205
 FWHM / FWTM 57.0° / 82.0°
 Efficiency 84 %
 Peak intensity 1 cd/lm
 LEDs/each optic 1
 Light colour White

Required components:

C12292_LENINA-STD-BASE-MEZ
 C12606_LENINA-DL

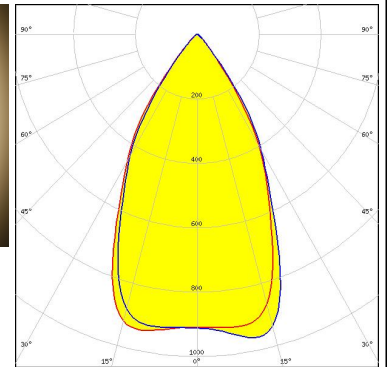

LUMILEDS

LED LUXEON CoB 1204HD
 FWHM / FWTM 51.0° / 79.0°
 Efficiency 91 %
 Peak intensity 1.4 cd/lm
 LEDs/each optic 1
 Light colour White

Required components:

C11981_LENINA-STD-BASE-COB-L110

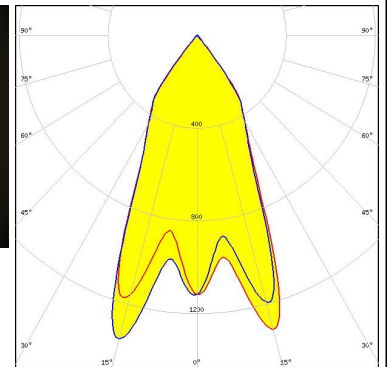
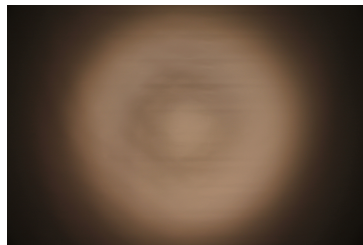

OPTICAL RESULTS (MEASURED):

LUMILEDS
 LED LUXEON CoB 1205HD
 FWHM / FWTM 54.0° / 80.0°
 Efficiency 91 %
 Peak intensity 1.3 cd/lm
 LEDs/each optic 1
 Light colour White
 Required components:
 C11981_LENINA-STD-BASE-COB-L110

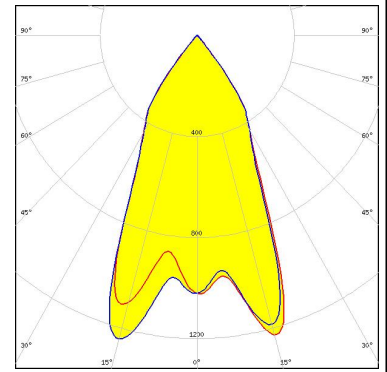

LUMILEDS
 LED LUXEON CoB 1208
 FWHM / FWTM 58.0° / 82.0°
 Efficiency 88 %
 Peak intensity 1 cd/lm
 LEDs/each optic 1
 Light colour White
 Required components:
 C12292_LENINA-STD-BASE-MEZ

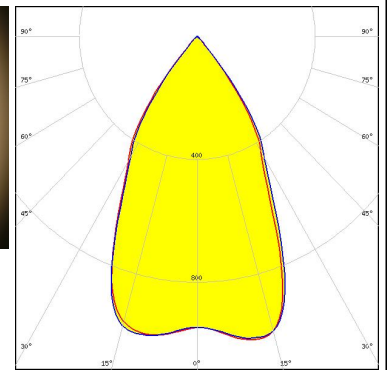
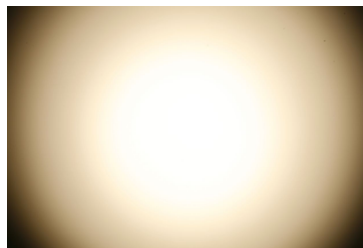

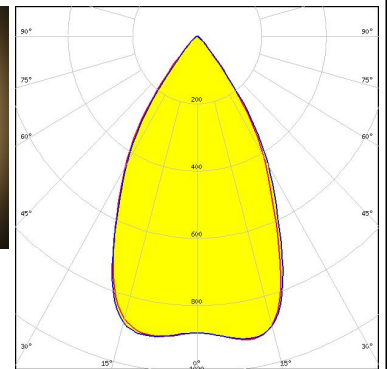
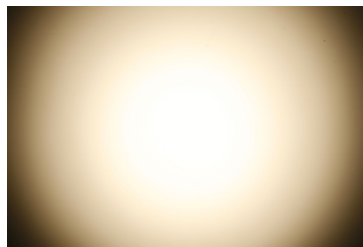

LUMILEDS
 LED LUXEON CoB 1208
 FWHM / FWTM 60.0° / 83.0°
 Efficiency 84 %
 Peak intensity 0.9 cd/lm
 LEDs/each optic 1
 Light colour White
 Required components:
 C12292_LENINA-STD-BASE-MEZ
 C12606_LENINA-DL

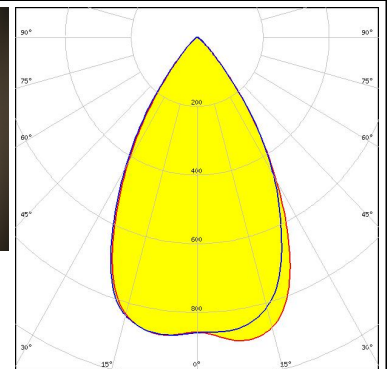
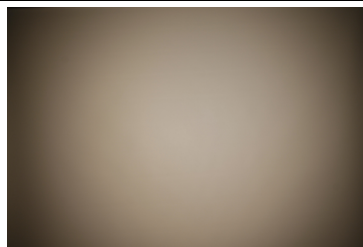

LUMILEDS
 LED LUXEON CoB 1211
 FWHM / FWTM 60.0° / 86.0°
 Efficiency 86 %
 Peak intensity 0.9 cd/lm
 LEDs/each optic 1
 Light colour White
 Required components:
 C13867_LENINA-STD-BASE-VERO29
 C12606_LENINA-DL
 Bender Wirth: 431 Typ L3

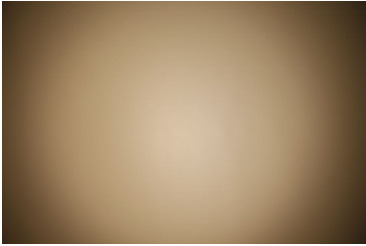
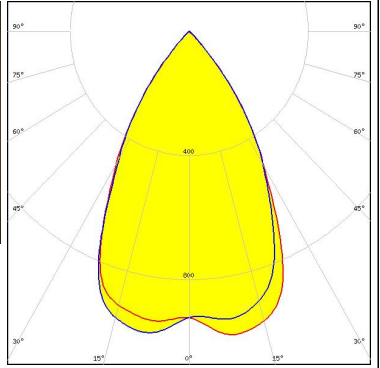
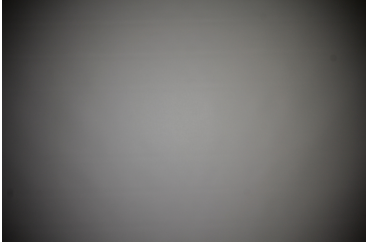
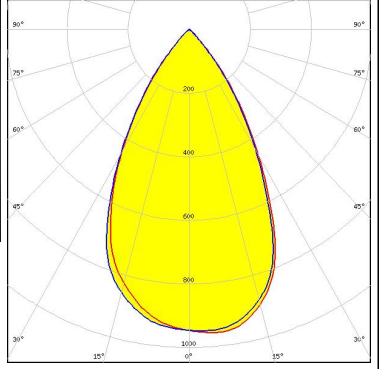

OPTICAL RESULTS (MEASURED):

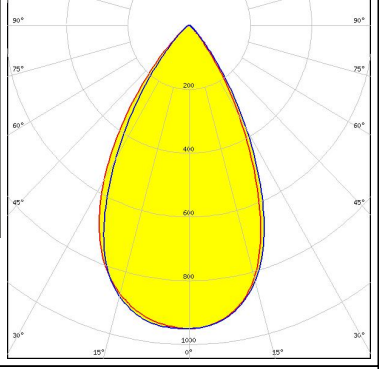
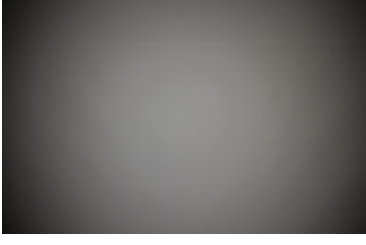
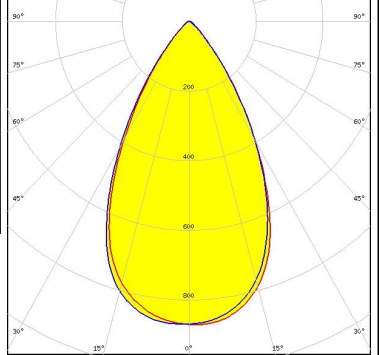
<p>LUMILEDS</p> <p>LED LUXEON CoB 1211</p> <p>FWHM / FWTM 60.0° / 84.0°</p> <p>Efficiency 91 %</p> <p>Peak intensity 1 cd/lm</p> <p>LEDs/each optic 1</p> <p>Light colour White</p> <p>Required components: C13867_LENINA-STD-BASE-VERO29 Bender Wirth: 431 Typ L3</p>		
<p>LUMILEDS</p> <p>LED LUXEON CoB 1213/1216/1812</p> <p>FWHM / FWTM 58.0° / 85.0°</p> <p>Efficiency 84 %</p> <p>Peak intensity 1 cd/lm</p> <p>LEDs/each optic 1</p> <p>Light colour White</p> <p>Required components: A.A.G. STUCCHI: 8102-G2 + S-8000-12</p>		
<p>LUMILEDS</p> <p>LED LUXEON CoB 1213/1216/1812</p> <p>FWHM / FWTM 58.0° / 85.0°</p> <p>Efficiency 86 %</p> <p>Peak intensity 1 cd/lm</p> <p>LEDs/each optic 1</p> <p>Light colour White</p> <p>Required components: C12692_LENINA-STD-BASE-CLL040 C12606_LENINA-DL</p>		
<p>LUMILEDS</p> <p>LED LUXEON CoB 1213/1216/1812</p> <p>FWHM / FWTM 58.0° / 86.0°</p> <p>Efficiency 80 %</p> <p>Peak intensity 0.9 cd/lm</p> <p>LEDs/each optic 1</p> <p>Light colour White</p> <p>Required components: C12606_LENINA-DL A.A.G. STUCCHI: 8102-G2 + S-8000-12</p>		

OPTICAL RESULTS (MEASURED):

LUMILEDS

LED LUXEON CoB 1213/1216/1812
 FWHM / FWTM 58.0° / 84.0°
 Efficiency 90 %
 Peak intensity 1 cd/lm
 LEDs/each optic 1
 Light colour White
 Required components:
 C12692_LENINA-STD-BASE-CLL040

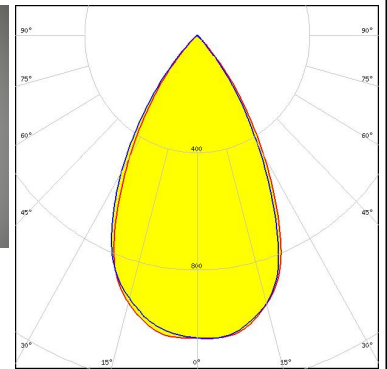

LUMILEDS

LED LUXEON K12
 FWHM / FWTM 57.0° / 83.0°
 Efficiency 83 %
 Peak intensity 1 cd/lm
 LEDs/each optic 1
 Light colour White
 Required components:
 C12924_LENINA-STD-BASE-LUXEON-K
 C12606_LENINA-DL

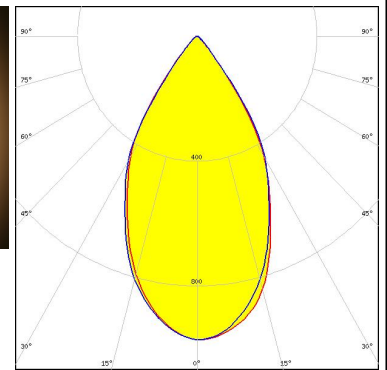
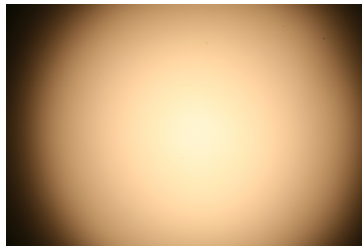

LUMILEDS

LED LUXEON K12
 FWHM / FWTM 54.0° / 81.0°
 Efficiency 88 %
 Peak intensity 1.1 cd/lm
 LEDs/each optic 1
 Light colour White
 Required components:
 C12924_LENINA-STD-BASE-LUXEON-K

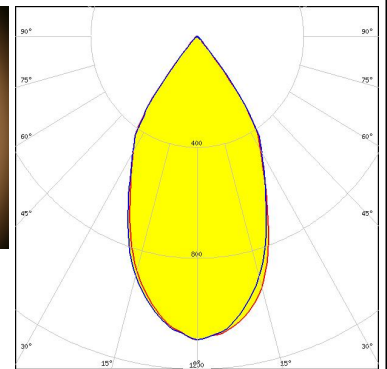
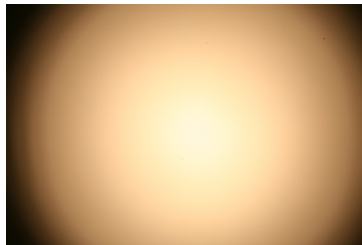

LUMILEDS



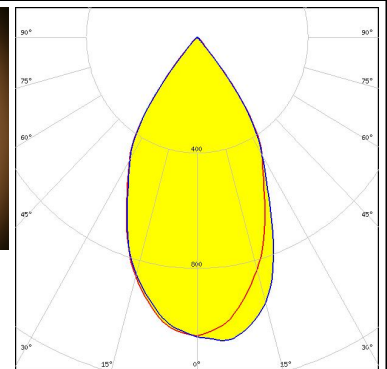
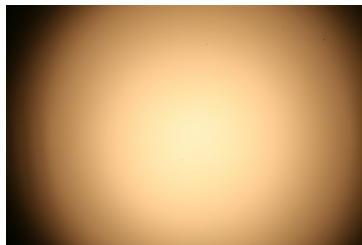

LED LUXEON K16
 FWHM / FWTM 55.0° / 81.0°
 Efficiency 85 %
 Peak intensity 1.1 cd/lm
 LEDs/each optic 1
 Light colour White
 Required components:
 C12924_LENINA-STD-BASE-LUXEON-K

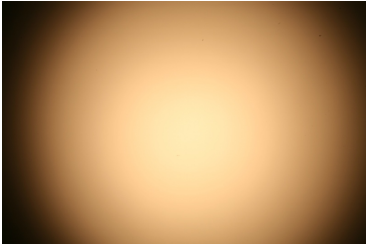
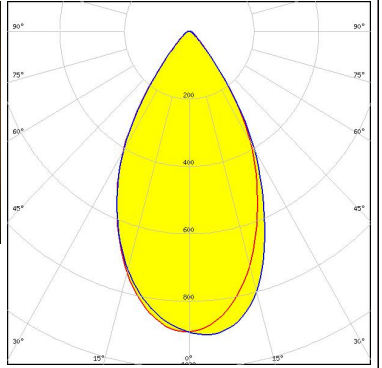
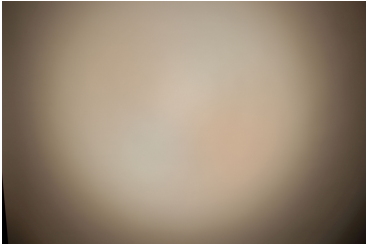
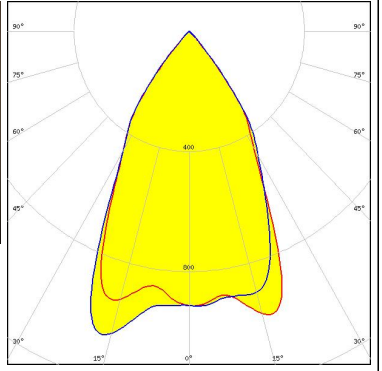
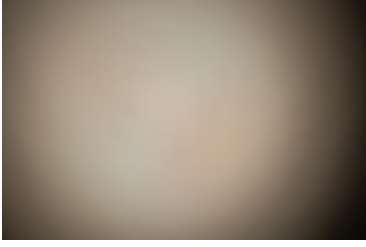
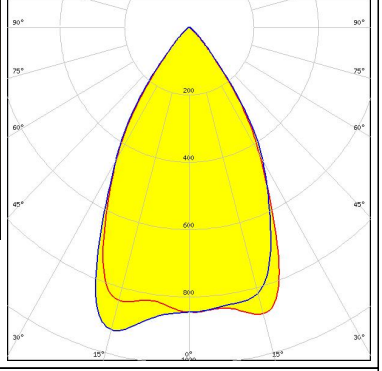
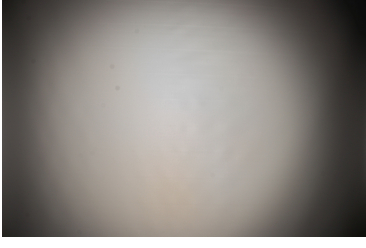
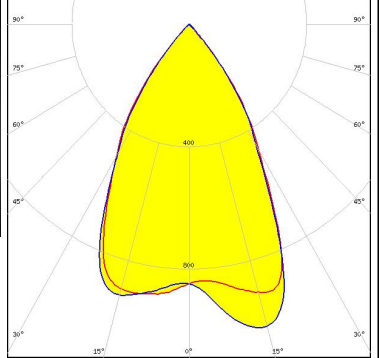



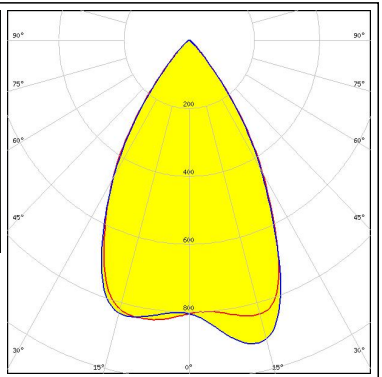

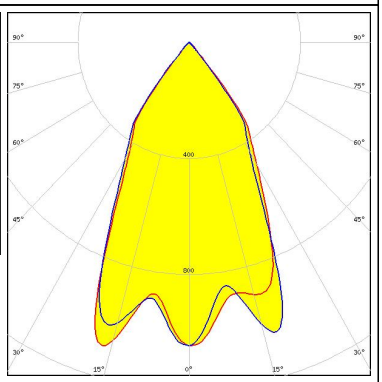

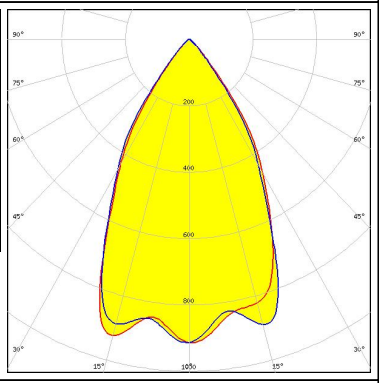
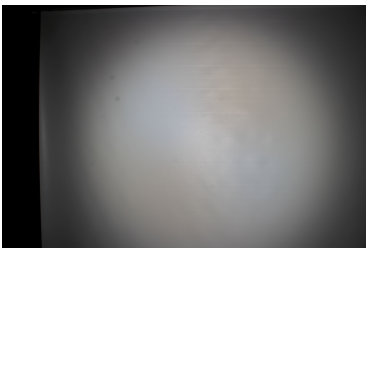
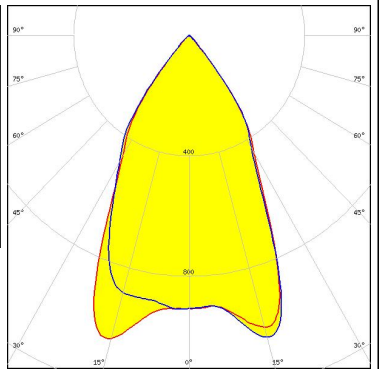
OPTICAL RESULTS (MEASURED):

<p>LUMILEDS</p> <p>LED LUXEON K16</p> <p>FWHM / FWTM 56.0° / 85.0°</p> <p>Efficiency 79 %</p> <p>Peak intensity 0.9 cd/m</p> <p>LEDs/each optic 1</p> <p>Light colour White</p> <p>Required components: C12924_LENASTD-BASE-LUXEON-K C12606_LENINA-DL</p>		
<p>LUMINUS</p> <p>LED CDM-14 (Dim-To-Warm)</p> <p>FWHM / FWTM 58.0° / 83.0°</p> <p>Efficiency 91 %</p> <p>Peak intensity 1.1 cd/m</p> <p>LEDs/each optic 1</p> <p>Light colour White</p> <p>Required components: C13868_LENASTD-BASE-VERO13-18 Bender Wirth: 491 Typ L2</p>		
<p>LUMINUS</p> <p>LED CDM-14 (Dim-To-Warm)</p> <p>FWHM / FWTM 60.0° / 85.0°</p> <p>Efficiency 86 %</p> <p>Peak intensity 0.9 cd/m</p> <p>LEDs/each optic 1</p> <p>Light colour White</p> <p>Required components: C13868_LENASTD-BASE-VERO13-18 C12606_LENINA-DL Bender Wirth: 491 Typ L2</p>		
<p>LUMINUS</p> <p>LED CDM-18 (Dim-To-Warm)</p> <p>FWHM / FWTM 64.0° / 85.0°</p> <p>Efficiency 91 %</p> <p>Peak intensity 1 cd/m</p> <p>LEDs/each optic 1</p> <p>Light colour White</p> <p>Required components: C13868_LENASTD-BASE-VERO13-18 Bender Wirth: 491 Typ L2</p>		

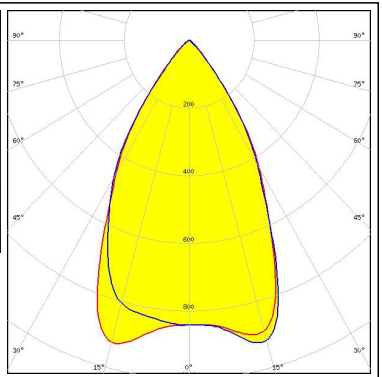

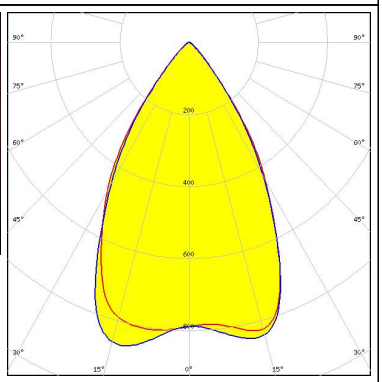
OPTICAL RESULTS (MEASURED):

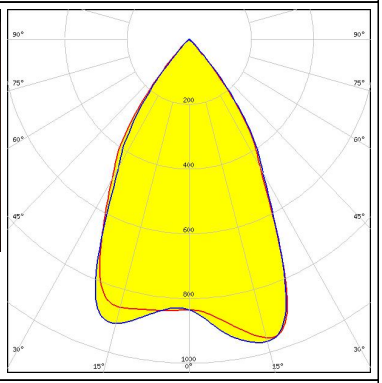
<p>LUMINUS</p> <p>LED CDM-18 (Dim-To-Warm)</p> <p>FWHM / FWTM 62.0° / 86.0°</p> <p>Efficiency 86 %</p> <p>Peak intensity 0.9 cd/lm</p> <p>LEDs/each optic 1</p> <p>Light colour White</p> <p>Required components:</p> <p>C13868_LENINA-STD-BASE-VERO13-18</p> <p>C12606_LENINA-DL</p> <p>Bender Wirth: 491 Typ L2</p>		
<p>LUMINUS</p> <p>LED CDM-9 (Dim-To-Warm)</p> <p>FWHM / FWTM 55.0° / 81.0°</p> <p>Efficiency 90 %</p> <p>Peak intensity 1.1 cd/lm</p> <p>LEDs/each optic 1</p> <p>Light colour White</p> <p>Required components:</p> <p>C13868_LENINA-STD-BASE-VERO13-18</p> <p>Bender Wirth: 490 Typ L1</p>		
<p>LUMINUS</p> <p>LED CDM-9 (Dim-To-Warm)</p> <p>FWHM / FWTM 59.0° / 83.0°</p> <p>Efficiency 86 %</p> <p>Peak intensity 1 cd/lm</p> <p>LEDs/each optic 1</p> <p>Light colour White</p> <p>Required components:</p> <p>C13868_LENINA-STD-BASE-VERO13-18</p> <p>C12606_LENINA-DL</p> <p>Bender Wirth: 490 Typ L1</p>		
<p>LUMINUS</p> <p>LED CTM-14 (Tunable White)</p> <p>FWHM / FWTM 58.0° / 83.0°</p> <p>Efficiency 91 %</p> <p>Peak intensity 1.1 cd/lm</p> <p>LEDs/each optic 1</p> <p>Light colour White</p> <p>Required components:</p> <p>C13867_LENINA-STD-BASE-VERO29</p> <p>Bender Wirth: 442 Typ L3</p>		

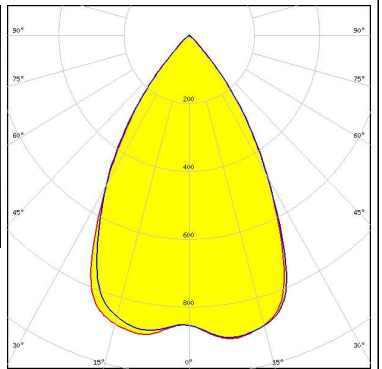
OPTICAL RESULTS (MEASURED):

<p>LUMINUS</p> <p>LED CTM-14 (Tunable White) FWHM / FWTM 60.0° / 85.0° Efficiency 86 % Peak intensity 1 cd/lm LEDs/each optic 1 Light colour White</p> <p>Required components: C13867_LENINA-STD-BASE-VERO29 C12606_LENINA-DL Bender Wirth: 442 Typ L3</p>		
<p>LUMINUS</p> <p>LED CTM-18 (Tunable White) FWHM / FWTM 63.0° / 87.0° Efficiency 85 % Peak intensity 0.9 cd/lm LEDs/each optic 1 Light colour White</p> <p>Required components: C13867_LENINA-STD-BASE-VERO29 C12606_LENINA-DL Bender Wirth: 442 Typ L3</p>		
<p>LUMINUS</p> <p>LED CTM-18 (Tunable White) FWHM / FWTM 32.0° / 76.0° Efficiency 92 % Peak intensity 2 cd/lm LEDs/each optic 1 Light colour White</p> <p>Required components: C13867_LENINA-STD-BASE-VERO29 Bender Wirth: 442 Typ L3</p>		
<p>LUMINUS</p> <p>LED CTM-22 (Tunable White) FWHM / FWTM 63.0° / 87.0° Efficiency 90 % Peak intensity 0.9 cd/lm LEDs/each optic 1 Light colour White</p> <p>Required components: C13867_LENINA-STD-BASE-VERO29 Bender Wirth: 494 Typ L3</p>		

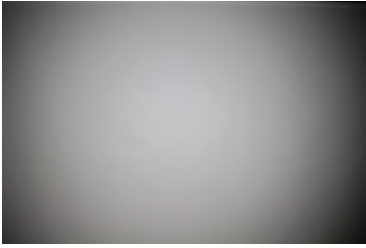
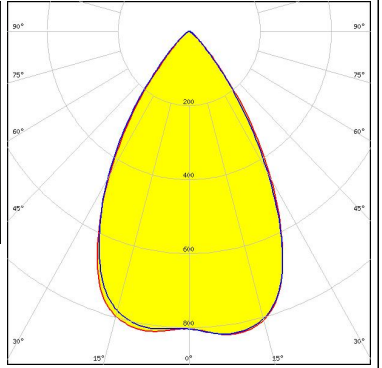
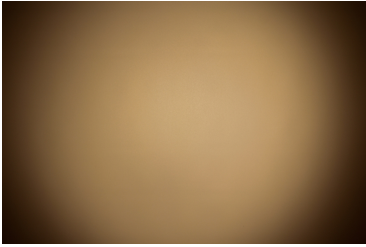
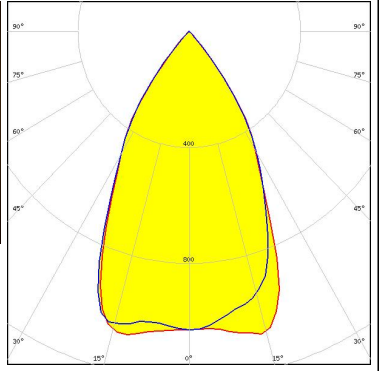
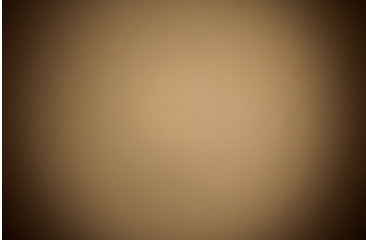
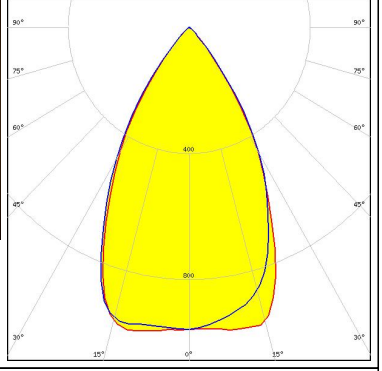
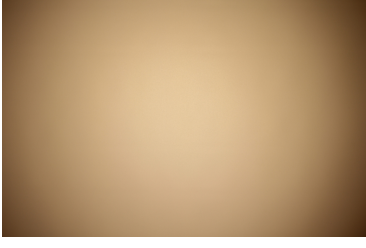
OPTICAL RESULTS (MEASURED):

<p>LUMINUS</p> <p>LED CTM-22 (Tunable White)</p> <p>FWHM / FWTM 63.0° / 89.0°</p> <p>Efficiency 85 %</p> <p>Peak intensity 0.8 cd/lm</p> <p>LEDs/each optic 1</p> <p>Light colour White</p> <p>Required components: C13867_LENINA-STD-BASE-VERO29 C12606_LENINA-DL Bender Wirth: 494 Typ L3</p>		
<p>LUMINUS</p> <p>LED CxM-14 (19x19)</p> <p>FWHM / FWTM 58.0° / 82.0°</p> <p>Efficiency 92 %</p> <p>Peak intensity 1.1 cd/lm</p> <p>LEDs/each optic 1</p> <p>Light colour White</p> <p>Required components: C12691_LENINA-STD-BASE-CLL030</p>		
<p>LUMINUS</p> <p>LED CxM-14 (19x19)</p> <p>FWHM / FWTM 59.0° / 84.0°</p> <p>Efficiency 88 %</p> <p>Peak intensity 1 cd/lm</p> <p>LEDs/each optic 1</p> <p>Light colour White</p> <p>Required components: C12691_LENINA-STD-BASE-CLL030 C12606_LENINA-DL</p>		
<p>LUMINUS</p> <p>LED CxM-22 (28x28)</p> <p>FWHM / FWTM 58.0° / 86.0°</p> <p>Efficiency 92 %</p> <p>Peak intensity 1.1 cd/lm</p> <p>LEDs/each optic 1</p> <p>Light colour White</p> <p>Required components: C12692_LENINA-STD-BASE-CLL040</p>		

OPTICAL RESULTS (MEASURED):



LED CxM-22 (28x28)
 FWHM / FWTM 58.0° / 86.0°
 Efficiency 87 %
 Peak intensity 1 cd/lm
 LEDs/each optic 1
 Light colour White

Required components:

C12692_LENASTD-BASE-CLL040
 C12606_LENINA-DL

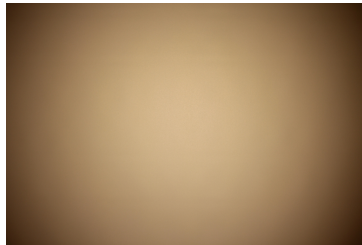

LED COB J-Type
 FWHM / FWTM 59.0° / 84.0°
 Efficiency 82 %
 Peak intensity 0.9 cd/lm
 LEDs/each optic 1
 Light colour White

Required components:

C12292_LENASTD-BASE-MEZ
 C12606_LENINA-DL

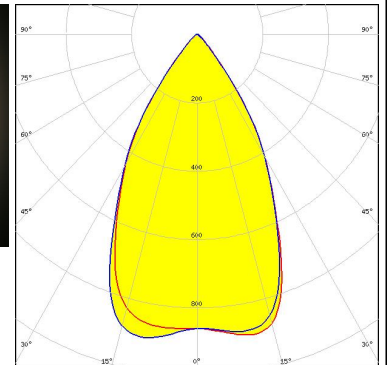
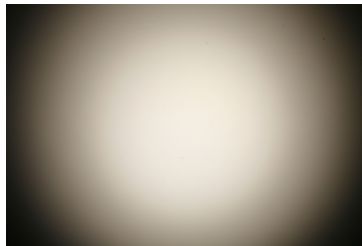

LED COB J-Type
 FWHM / FWTM 59.0° / 83.0°
 Efficiency 91 %
 Peak intensity 1.1 cd/lm
 LEDs/each optic 1
 Light colour White

Required components:

C13868_LENASTD-BASE-VERO13-18
 Bender Wirth: 463 Typ L2

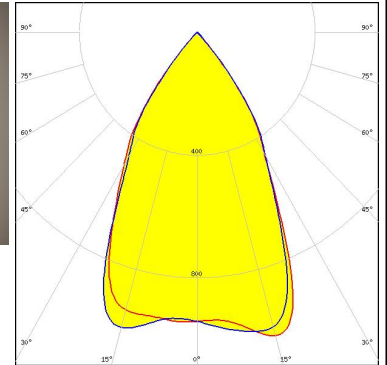
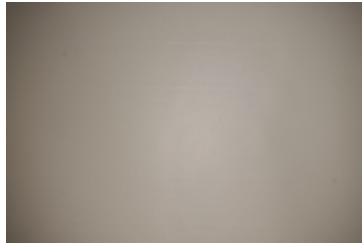

LED COB J-Type
 FWHM / FWTM 59.0° / 84.0°
 Efficiency 87 %
 Peak intensity 1 cd/lm
 LEDs/each optic 1
 Light colour White

Required components:



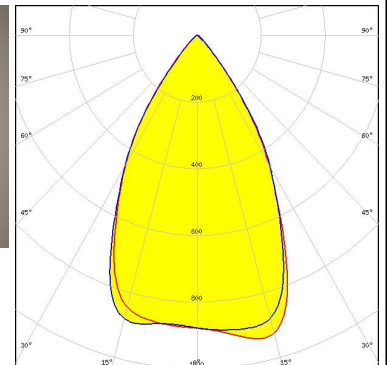
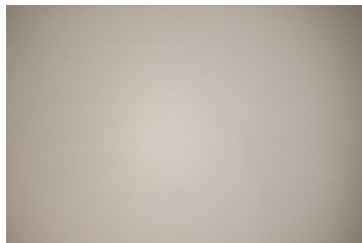

C13868_LENASTD-BASE-VERO13-18
 C12606_LENINA-DL
 Bender Wirth: 463 Typ L2

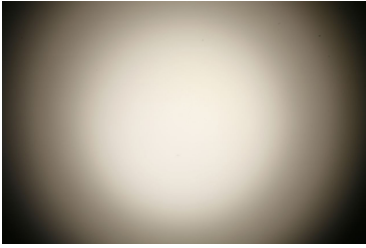
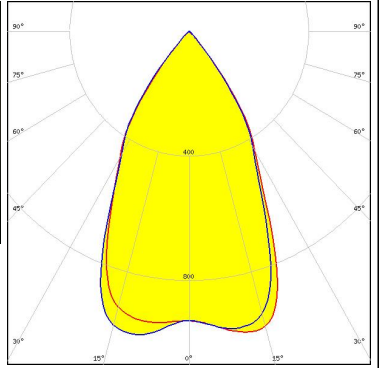
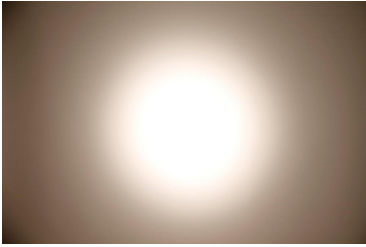
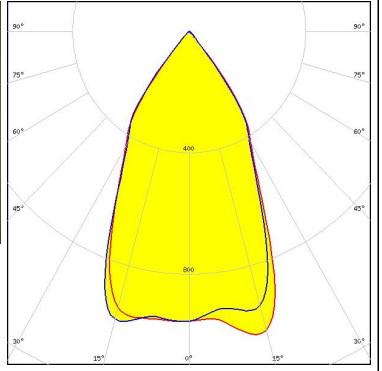
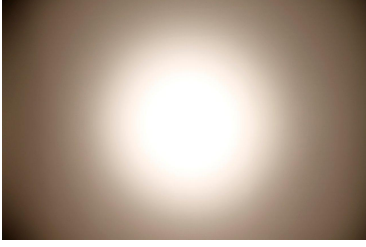
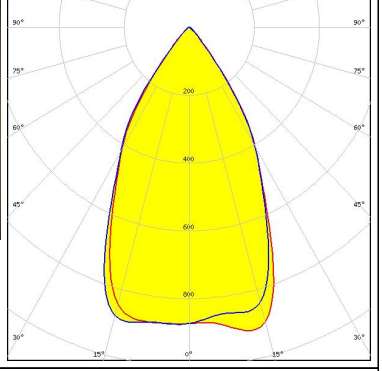
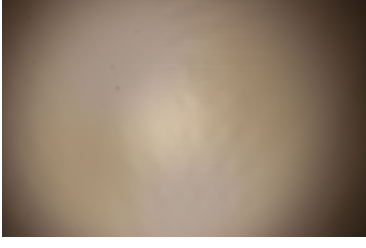
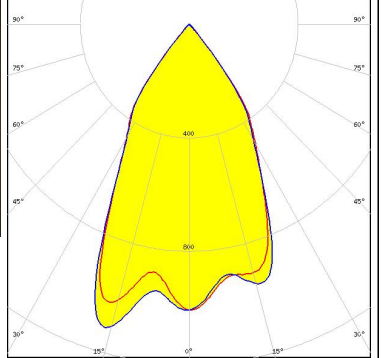

OPTICAL RESULTS (MEASURED):

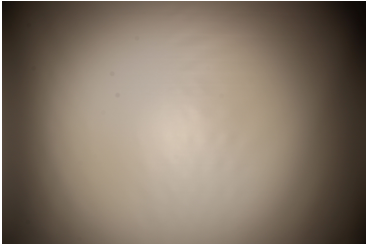
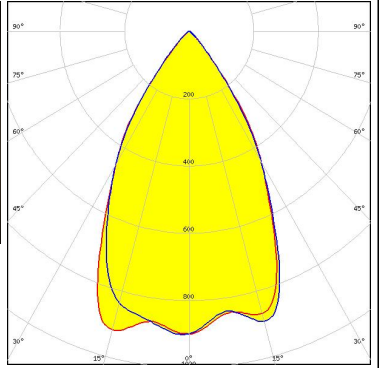
<p>NICHIA</p> <p>LED COB J-Type FWHM / FWTM 58.0° / 82.0° Efficiency 86 % Peak intensity 1 cd/lm LEDs/each optic 1 Light colour White Required components: C12292_LENINA-STD-BASE-MEZ</p>		
<p>NICHIA</p> <p>LED COB L-Type (LES 11) FWHM / FWTM 56.0° / 81.0° Efficiency 85 % Peak intensity 1 cd/lm LEDs/each optic 1 Light colour White Required components: C11981_LENINA-STD-BASE-COB-L110</p>		
<p>NICHIA</p> <p>LED COB L-Type (LES 11) FWHM / FWTM 58.0° / 82.0° Efficiency 80 % Peak intensity 0.9 cd/lm LEDs/each optic 1 Light colour White Required components: C11981_LENINA-STD-BASE-COB-L110 C12606_LENINA-DL</p>		
<p>NICHIA</p> <p>LED NVCWJ024Z-V1MT: COB J-Type Tunable White FWHM / FWTM 56.0° / 81.0° Efficiency 91 % Peak intensity 1.1 cd/lm LEDs/each optic 1 Light colour White Required components: C13868_LENINA-STD-BASE-VERO13-18 Bender Wirth: 498 Typ L2</p>		

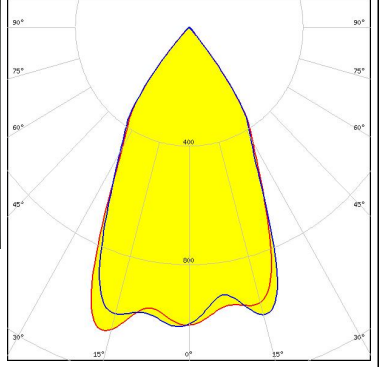
OPTICAL RESULTS (MEASURED):

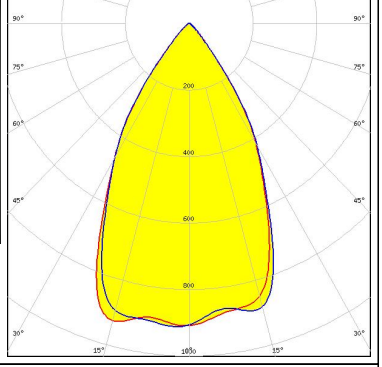
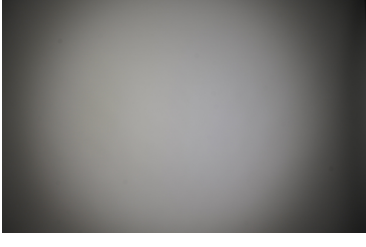
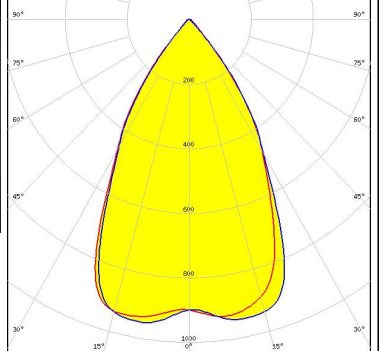
<p>NICHIA</p> <p>LED NVCWJ024Z-V1MT: COB J-Type Tunable White</p> <p>FWHM / FWTM 60.0° / 84.0°</p> <p>Efficiency 86 %</p> <p>Peak intensity 0.9 cd/lm</p> <p>LEDs/each optic 1</p> <p>Light colour White</p> <p>Required components: C13868_LENINA-STD-BASE-VERO13-18 C12606_LENINA-DL Bender Wirth: 498 Typ L2</p>		
<p>OSRAM Opto Semiconductors</p> <p>LED Soleriq S13</p> <p>FWHM / FWTM 56.0° / 81.0°</p> <p>Efficiency 90 %</p> <p>Peak intensity 1.1 cd/lm</p> <p>LEDs/each optic 1</p> <p>Light colour White</p> <p>Required components: C13868_LENINA-STD-BASE-VERO13-18 Bender Wirth: 437 Typ L1</p>		
<p>OSRAM Opto Semiconductors</p> <p>LED Soleriq S13</p> <p>FWHM / FWTM 59.0° / 83.0°</p> <p>Efficiency 86 %</p> <p>Peak intensity 0.9 cd/lm</p> <p>LEDs/each optic 1</p> <p>Light colour White</p> <p>Required components: C13868_LENINA-STD-BASE-VERO13-18 C12606_LENINA-DL Bender Wirth: 437 Typ L1</p>		
<p>OSRAM Opto Semiconductors</p> <p>LED Soleriq S19</p> <p>FWHM / FWTM 60.0° / 84.0°</p> <p>Efficiency 92 %</p> <p>Peak intensity 1 cd/lm</p> <p>LEDs/each optic 1</p> <p>Light colour White</p> <p>Required components: C13867_LENINA-STD-BASE-VERO29 Bender Wirth: 462 Typ L3</p>		

OPTICAL RESULTS (MEASURED):

OSRAM

Opto Semiconductors

LED Soleriq S19
 FWHM / FWTM 60.0° / 85.0°
 Efficiency 87 %
 Peak intensity 0.9 cd/lm
 LEDs/each optic 1
 Light colour White

Required components:

C13867_LENINA-STD-BASE-VERO29
 C12606_LENINA-DL
 Bender Wirth: 462 Typ L3

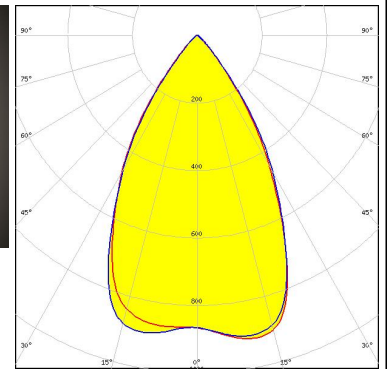
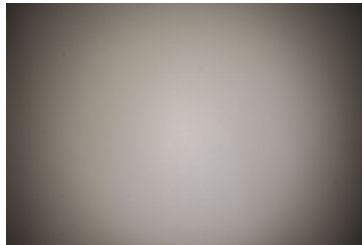

PHILIPS

LED Fortimo SLM L13 CoB
 FWHM / FWTM 57.0° / 83.0°
 Efficiency 85 %
 Peak intensity 1 cd/lm
 LEDs/each optic 1
 Light colour White

Required components:

C12292_LENINA-STD-BASE-MEZ
 C12606_LENINA-DL

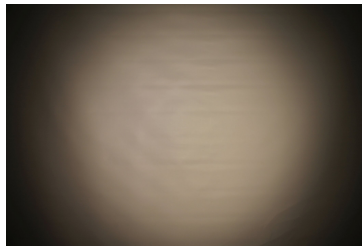

PHILIPS

LED Fortimo SLM L13 CoB
 FWHM / FWTM 57.0° / 81.0°
 Efficiency 92 %
 Peak intensity 1.2 cd/lm
 LEDs/each optic 1
 Light colour White

Required components:

C12292_LENINA-STD-BASE-MEZ

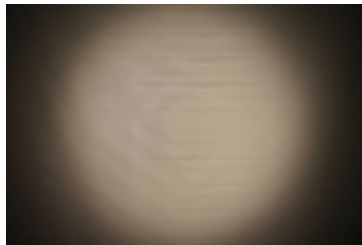

PHILIPS

LED Fortimo SLM L15 CoB
 FWHM / FWTM 56.0° / 83.0°
 Efficiency 85 %
 Peak intensity 1 cd/lm
 LEDs/each optic 1
 Light colour White

Required components:

C12292_LENINA-STD-BASE-MEZ
 C12606_LENINA-DL

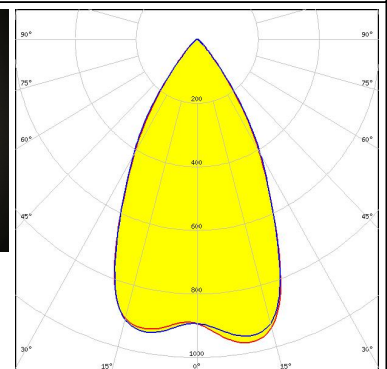
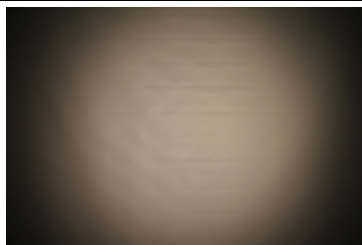

OPTICAL RESULTS (MEASURED):

PHILIPS

LED Fortimo SLM L15 CoB
 FWHM / FWTM 59.0° / 82.0°
 Efficiency 91 %
 Peak intensity 1.1 cd/lm
 LEDs/each optic 1
 Light colour White
 Required components:
 C12292_LENINA-STD-BASE-MEZ

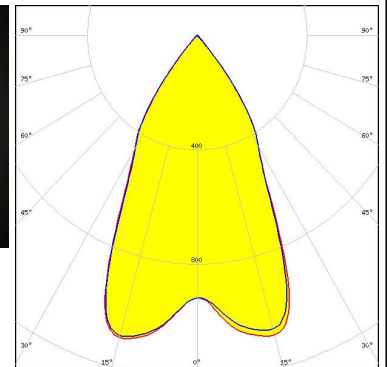

PHILIPS

LED Fortimo SLM L19 CoB
 FWHM / FWTM 54.0° / 83.0°
 Efficiency 86 %
 Peak intensity 1 cd/lm
 LEDs/each optic 1
 Light colour White
 Required components:
 C12692_LENINA-STD-BASE-CLL040
 C12606_LENINA-DL

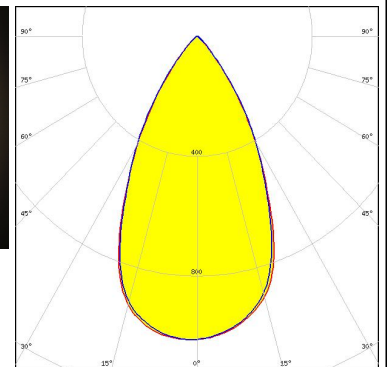
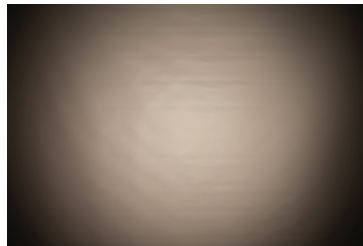

PHILIPS

LED Fortimo SLM L19 CoB
 FWHM / FWTM 53.0° / 81.0°
 Efficiency 91 %
 Peak intensity 1.1 cd/lm
 LEDs/each optic 1
 Light colour White
 Required components:
 C12692_LENINA-STD-BASE-CLL040

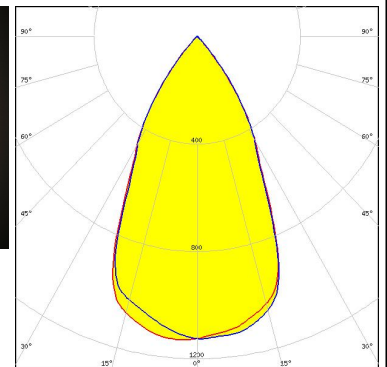
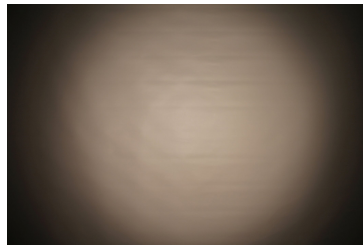

PHILIPS

LED Fortimo SLM L23 CoB
 FWHM / FWTM 57.0° / 84.0°
 Efficiency 85 %
 Peak intensity 1 cd/lm
 LEDs/each optic 1
 Light colour White
 Required components:
 C12292_LENINA-STD-BASE-MEZ
 C12606_LENINA-DL

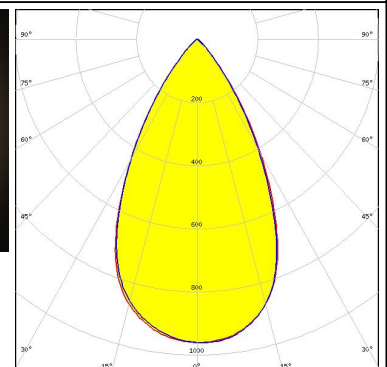
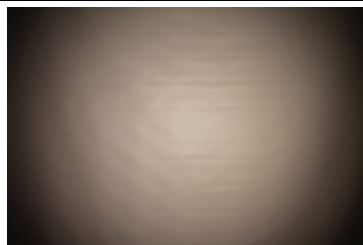

OPTICAL RESULTS (MEASURED):

PHILIPS

LED Fortimo SLM L23 CoB
 FWHM / FWTM 39.0° / 76.0°
 Efficiency 92 %
 Peak intensity 1.7 cd/lm
 LEDs/each optic 1
 Light colour White
 Required components:
 C12692_LENINA-STD-BASE-CLL040

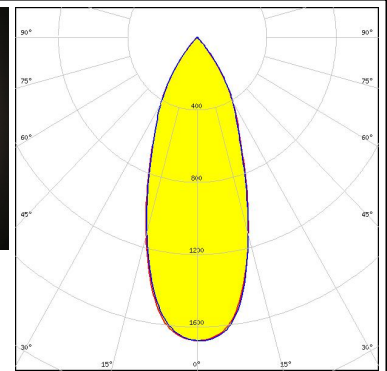
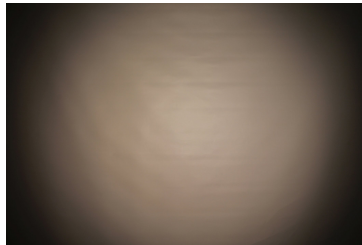

SAMSUNG

LED LC016D / LC019D / LC026D / LC033D
 FWHM / FWTM 59.0° / 84.0°
 Efficiency 87 %
 Peak intensity 1 cd/lm
 LEDs/each optic 1
 Light colour White
 Required components:
 C12691_LENINA-STD-BASE-CLL030
 C12606_LENINA-DL

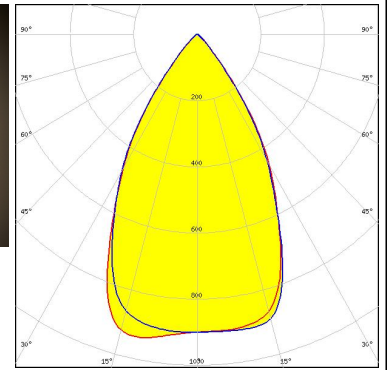
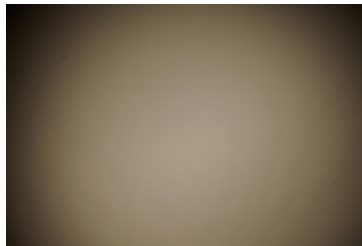

SAMSUNG

LED LC016D / LC019D / LC026D / LC033D
 FWHM / FWTM 57.0° / 82.0°
 Efficiency 91 %
 Peak intensity 1 cd/lm
 LEDs/each optic 1
 Light colour White
 Required components:
 C12691_LENINA-STD-BASE-CLL030

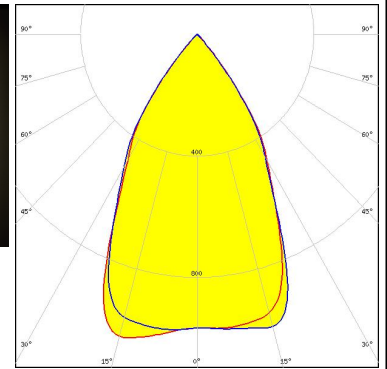
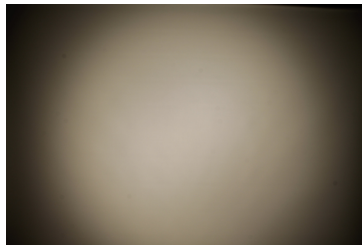

SAMSUNG

LED LC026B / 033B / 040B
 FWHM / FWTM 61.0° / 85.0°
 Efficiency 86 %
 Peak intensity 0.9 cd/lm
 LEDs/each optic 1
 Light colour White
 Required components:
 C13868_LENINA-STD-BASE-VERO13-18
 C12606_LENINA-DL
 Bender Wirth: 450 Typ L2

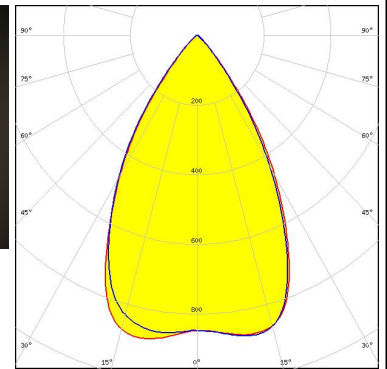
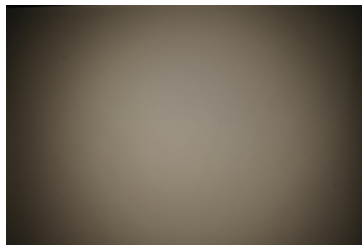

OPTICAL RESULTS (MEASURED):

SAMSUNG

LED LC026B / 033B / 040B
 FWHM / FWTM 61.0° / 84.0°
 Efficiency 91 %
 Peak intensity 1 cd/lm
 LEDs/each optic 1
 Light colour White
 Required components:
 C13868_LENA-STD-BASE-VERO13-18
 Bender Wirth: 450 Typ L2

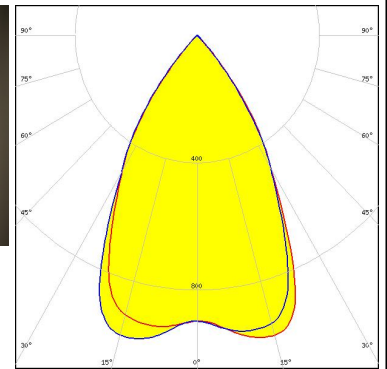
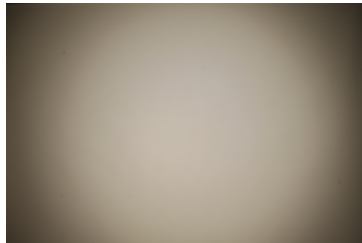

SAMSUNG

LED LC040D / LC060D / LC080D
 FWHM / FWTM 59.0° / 84.0°
 Efficiency 91 %
 Peak intensity 1 cd/lm
 LEDs/each optic 1
 Light colour White
 Required components:
 C12692_LENA-STD-BASE-CLL040

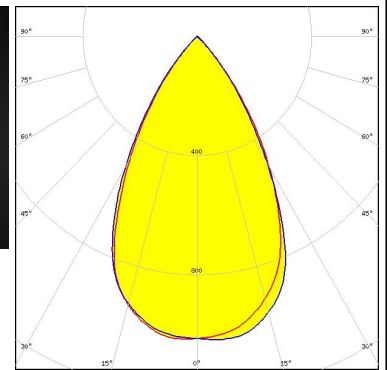
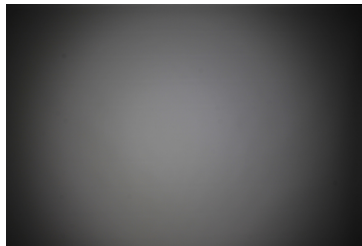

SAMSUNG

LED LC040D / LC060D / LC080D
 FWHM / FWTM 59.0° / 85.0°
 Efficiency 86 %
 Peak intensity 0.9 cd/lm
 LEDs/each optic 1
 Light colour White
 Required components:
 C12692_LENA-STD-BASE-CLL040
 C12606_LENINA-DL

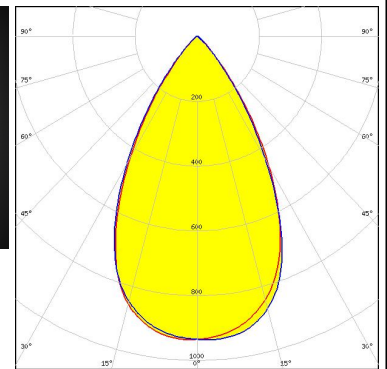
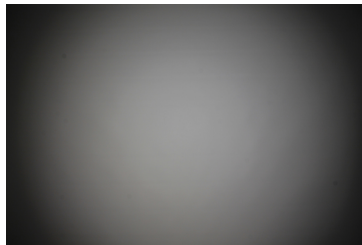





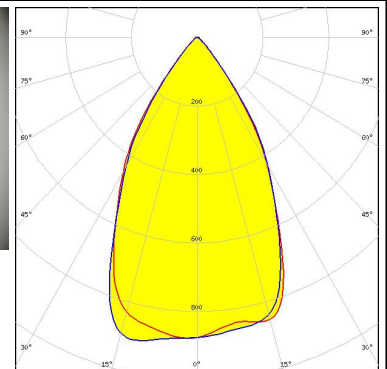

SEOL SEMICONDUCTOR

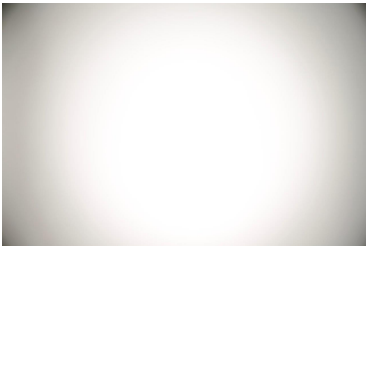
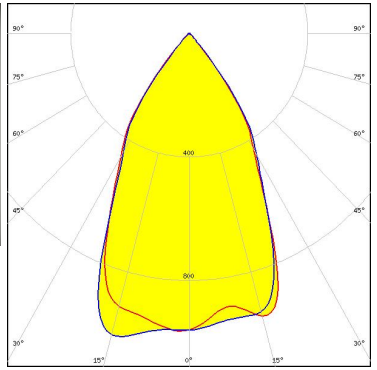
LED ZC12/18
 FWHM / FWTM 59.0° / 84.0°
 Efficiency 84 %
 Peak intensity 0.9 cd/lm
 LEDs/each optic 1
 Light colour White
 Required components:
 C12691_LENA-STD-BASE-CLL030
 C12606_LENINA-DL

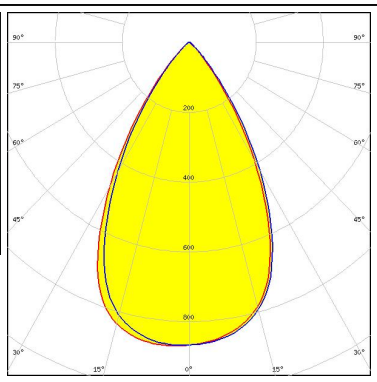

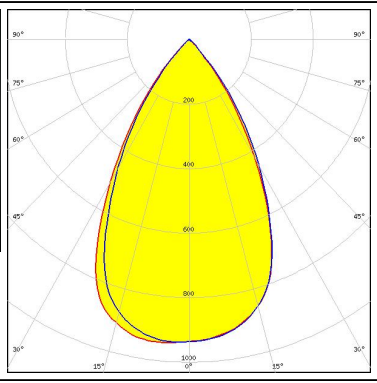
OPTICAL RESULTS (MEASURED):

<p>SEOUL SEMICONDUCTOR</p> <p>LED ZC12/18</p> <p>FWHM / FWTM 57.0° / 82.0°</p> <p>Efficiency 88 %</p> <p>Peak intensity 1 cd/lm</p> <p>LEDs/each optic 1</p> <p>Light colour White</p> <p>Required components: C12691_LENINA-STD-BASE-CLL030</p>		
<p>SEOUL SEMICONDUCTOR</p> <p>LED ZC25/40/60</p> <p>FWHM / FWTM 60.0° / 86.0°</p> <p>Efficiency 82 %</p> <p>Peak intensity 0.9 cd/lm</p> <p>LEDs/each optic 1</p> <p>Light colour White</p> <p>Required components: C12692_LENINA-STD-BASE-CLL040 C12606_LENINA-DL</p>		
<p>SEOUL SEMICONDUCTOR</p> <p>LED ZC25/40/60</p> <p>FWHM / FWTM 60.0° / 85.0°</p> <p>Efficiency 86 %</p> <p>Peak intensity 0.9 cd/lm</p> <p>LEDs/each optic 1</p> <p>Light colour White</p> <p>Required components: C12692_LENINA-STD-BASE-CLL040</p>		
<h2>SHARP</h2>		
<p>LED Mega Zenigata (GW5DGC)</p> <p>FWHM / FWTM 45.0° / 80.0°</p> <p>Efficiency 78 %</p> <p>LEDs/each optic 1</p> <p>Light colour White</p> <p>Required components: C12292_LENINA-STD-BASE-MEZ C12606_LENINA-DL</p>		

OPTICAL RESULTS (MEASURED):

SHARP

LED Mega Zenigata (GW5DGC)
FWHM / FWTM 41.0° / 77.0°
Efficiency 86 %
LEDs/each optic 1
Light colour White
Required components:
C12292_LENINA-STD-BASE-MEZ

SHARP

LED Mega Zenigata (GW6DME)
FWHM / FWTM 59.0° / 83.0°
Efficiency 83 %
Peak intensity 0.9 cd/lm
LEDs/each optic 1
Light colour White
Required components:
C12292_LENINA-STD-BASE-MEZ
C12606_LENINA-DL

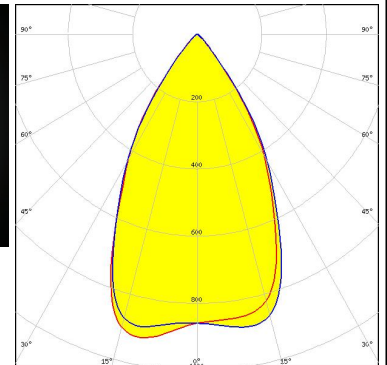
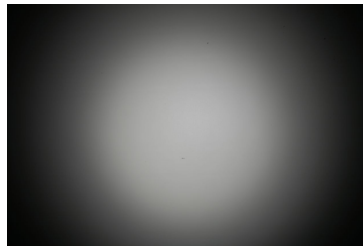

SHARP

LED Mega Zenigata (GW6DME)
FWHM / FWTM 57.0° / 82.0°
Efficiency 87 %
Peak intensity 1.1 cd/lm
LEDs/each optic 1
Light colour White
Required components:
C12292_LENINA-STD-BASE-MEZ

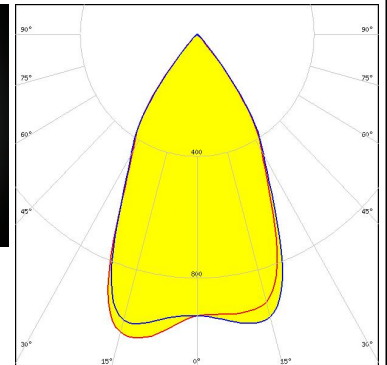
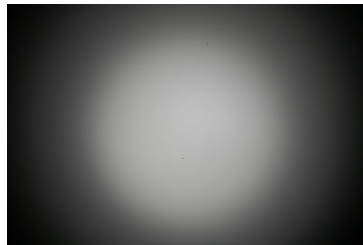

TRIDONIC

LED SLE G7 LES15
FWHM / FWTM 59.0° / 82.0°
Efficiency 92 %
Peak intensity 1.1 cd/lm
LEDs/each optic 1
Light colour White
Required components:
C12691_LENINA-STD-BASE-CLL030

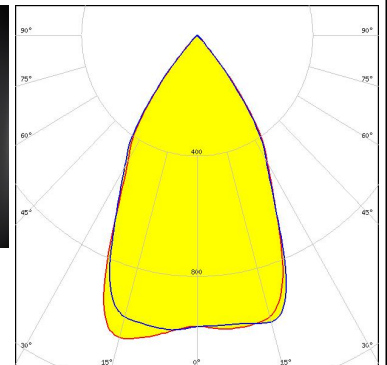
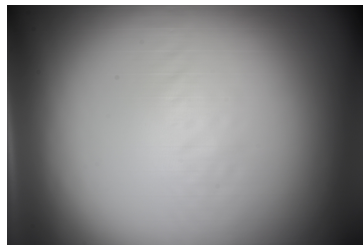

OPTICAL RESULTS (MEASURED):

TRIDONIC

LED SLE G7 LES17 H
FWHM / FWTM 56.0° / 82.0°
Efficiency 90 %
Peak intensity 1 cd/lm
LEDs/each optic 1
Light colour White
Required components:
C14547_LENINA-ADAPTER-B

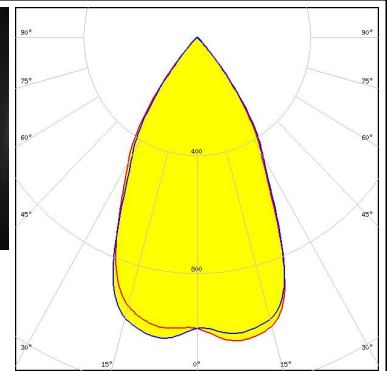
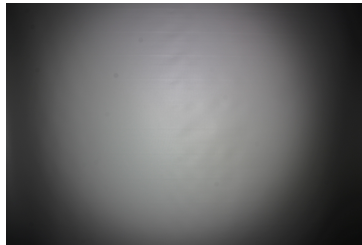





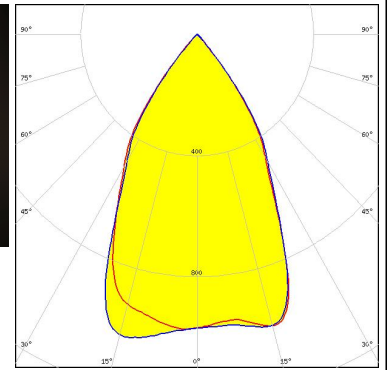
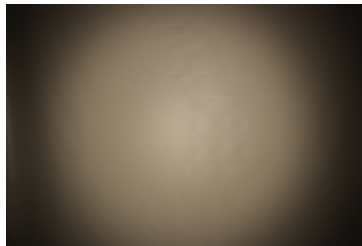

XICATO

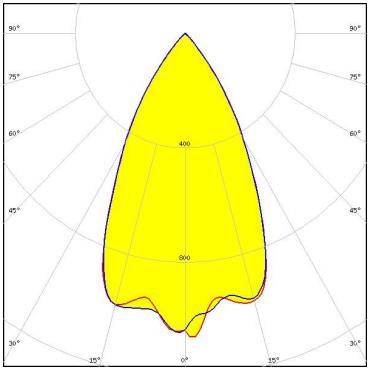

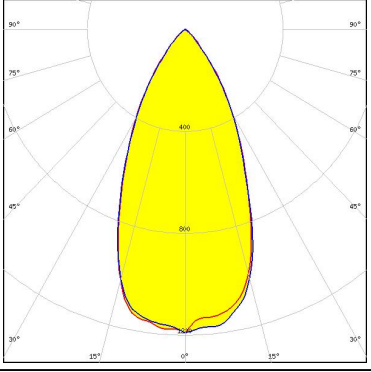

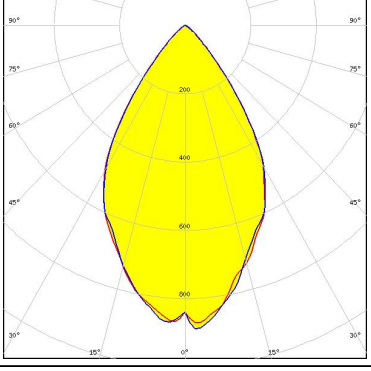

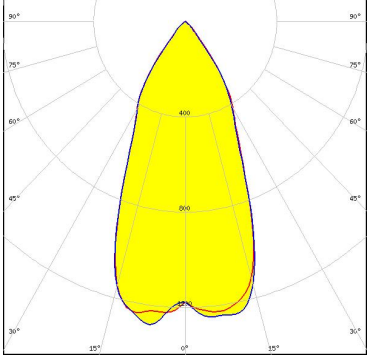
LED XOB 14.5 mm
FWHM / FWTM 58.0° / 82.0°
Efficiency 91 %
Peak intensity 1 cd/lm
LEDs/each optic 1
Light colour White
Required components:
C12691_LENINA-STD-BASE-CLL030

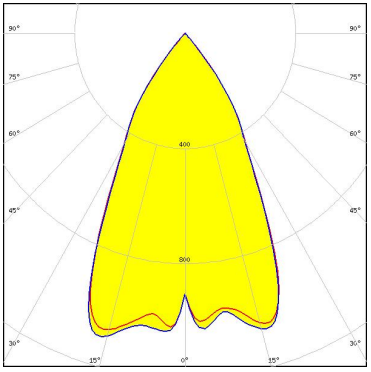

OPTICAL RESULTS (SIMULATED):

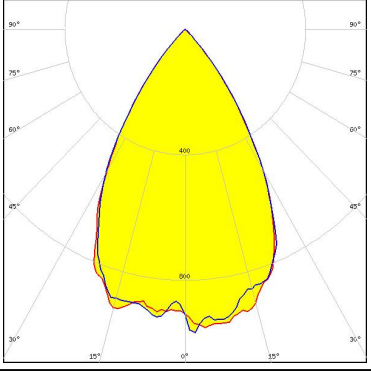
<p></p> <p>LED V10 Gen7 FWHM / FWTM 55.0° / 81.0° Efficiency 85 % Peak intensity 1.1 cd/lm LEDs/each optic 1 Light colour White</p> <p>Required components: C13868_LENINA-STD-BASE-VERO13-18 C12606_LENINA-DL Bender Wirth: 486 Typ L1</p>	
<p></p> <p>LED V13 Gen7 FWHM / FWTM 48.0° / 82.0° Efficiency 88 % Peak intensity 1.2 cd/lm LEDs/each optic 1 Light colour White</p> <p>Required components: C12606_LENINA-DL IDEAL: 50-2103CT + 50-2100AN</p>	
<p></p> <p>LED V13 Gen7 FWHM / FWTM 63.0° / 91.0° Efficiency 87 % Peak intensity 0.9 cd/lm LEDs/each optic 1 Light colour White</p> <p>Required components: C13868_LENINA-STD-BASE-VERO13-18 C12606_LENINA-DL Bender Wirth: 477 Typ L1</p>	
<p></p> <p>LED V13 Gen7 FWHM / FWTM 46.0° / 79.0° Efficiency 90 % Peak intensity 1.3 cd/lm LEDs/each optic 1 Light colour White</p> <p>Required components: IDEAL: 50-2103CT + 50-2100AN</p>	

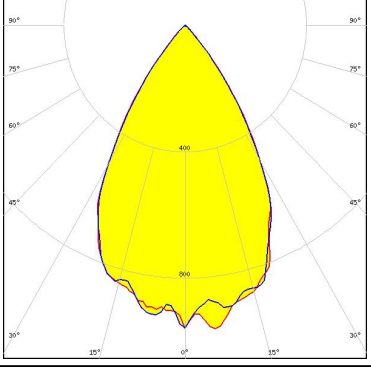
OPTICAL RESULTS (SIMULATED):

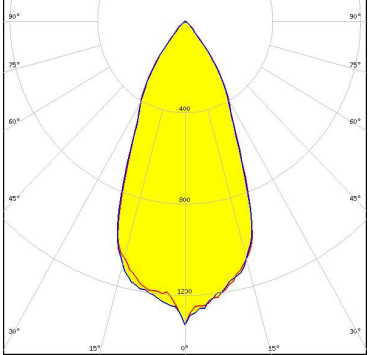
<p></p> <p>LED V13 Gen7 FWHM / FWTM 50.0° / 79.0° Efficiency 90 % Peak intensity 1.1 cd/lm LEDs/each optic 1 Light colour White Required components: C13868_LENASTD-BASE-VERO13-18 Bender Wirth: 477 Typ L1</p>	
<p></p> <p>LED V22 Gen7 FWHM / FWTM 61.0° / 84.0° Efficiency 90 % Peak intensity 1 cd/lm LEDs/each optic 1 Light colour White Required components: C13867_LENASTD-BASE-VERO29 Bender Wirth: 431 Typ L3</p>	
<p></p> <p>LED V22 Gen7 FWHM / FWTM 61.0° / 82.0° Efficiency 87 % Peak intensity 1 cd/lm LEDs/each optic 1 Light colour White Required components: C13867_LENASTD-BASE-VERO29 C12606_LENINA-DL Bender Wirth: 431 Typ L3</p>	
<p></p> <p>LED CXA/B 30xx FWHM / FWTM 46.0° / 80.0° Efficiency 89 % Peak intensity 1.3 cd/lm LEDs/each optic 1 Light colour White Required components: IDEAL: 50-2234C + 50-2100LN</p>	

OPTICAL RESULTS (SIMULATED):



LED CXA/B 30xx
FWHM / FWTM 49.0° / 81.0°
Efficiency 84 %
Peak intensity 1.2 cd/lm
LEDs/each optic 1
Light colour White
Required components:
 C12606_LENINA-DL
 IDEAL: 50-2234C + 50-2100LN

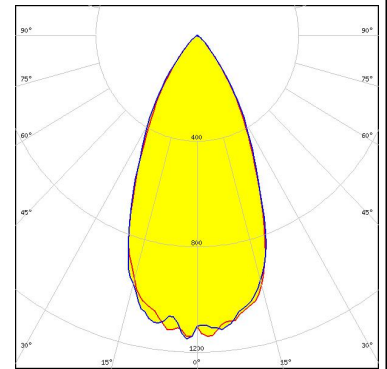

LED CxM-14 (19x19)
FWHM / FWTM 60.0° / 83.0°
Efficiency 86 %
Peak intensity 1 cd/lm
LEDs/each optic 1
Light colour White
Required components:
 C13868_LENINA-STD-BASE-VERO13-18
 C12606_LENINA-DL
 Bender Wirth: 433 Typ L1



LED CxM-14 (19x19)
FWHM / FWTM 57.0° / 82.0°
Efficiency 90 %
Peak intensity 1 cd/lm
LEDs/each optic 1
Light colour White
Required components:
 C13868_LENINA-STD-BASE-VERO13-18
 Bender Wirth: 433 Typ L1



LED CxM-9 (13.5x13.5)
FWHM / FWTM 54.0° / 80.0°
Efficiency 90 %
Peak intensity 1.1 cd/lm
LEDs/each optic 1
Light colour White
Required components:
 C13868_LENINA-STD-BASE-VERO13-18

OPTICAL RESULTS (SIMULATED):



LED CxM-9 (13.5x13.5)
 FWHM / FWTM 57.0° / 82.0°
 Efficiency 86 %
 Peak intensity 1 cd/lm
 LEDs/each optic 1
 Light colour White
 Required components:
 C13868_LENINA-STD-BASE-VERO13-18
 C12606_LENINA-DL
 Bender Wirth: 434 Typ L1



LED Soleriq S15
 FWHM / FWTM 56.0° / 81.0°
 Efficiency 90 %
 Peak intensity 1.1 cd/lm
 LEDs/each optic 1
 Light colour White
 Required components:
 C12691_LENINA-STD-BASE-CLL030

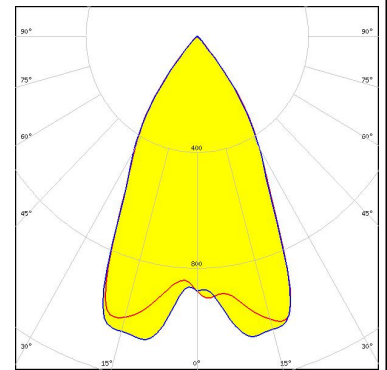

SEOUL SEMICONDUCTOR

LED ZC12/18
 FWHM / FWTM 57.0° / 82.0°
 Efficiency 90 %
 Peak intensity 1 cd/lm
 LEDs/each optic 1
 Light colour White
 Required components:
 C13868_LENINA-STD-BASE-VERO13-18
 Bender Wirth: 433 Typ L1



SEOUL SEMICONDUCTOR

LED ZC12/18
 FWHM / FWTM 60.0° / 83.0°
 Efficiency 86 %
 Peak intensity 1 cd/lm
 LEDs/each optic 1
 Light colour White
 Required components:
 C13868_LENINA-STD-BASE-VERO13-18
 C12606_LENINA-DL
 Bender Wirth: 433 Typ L1

OPTICAL RESULTS (SIMULATED):

	
SEOL SEMICONDUCTOR	
LED	ZC4/6
FWHM / FWTM	54.0° / 80.0°
Efficiency	90 %
Peak intensity	1.1 cd/lm
LEDs/each optic	1
Light colour	White
Required components:	
C13868_LENINA-STD-BASE-VERO13-18	
Bender Wirth: 434 Typ L1	
<hr/>	
	
SEOL SEMICONDUCTOR	
LED	ZC4/6
FWHM / FWTM	57.0° / 82.0°
Efficiency	86 %
Peak intensity	1 cd/lm
LEDs/each optic	1
Light colour	White
Required components:	
C13868_LENINA-STD-BASE-VERO13-18	
C12606_LENINA-DL	
Bender Wirth: 434 Typ L1	

GENERAL INFORMATION:

NOTE: The typical beam angle will be changed by different color, chip size and chip position tolerance. The typical total beam angle is the full angle measured where the luminous intensity is half of the peak value.

Due to use of high power COB's with this product, special attention to proper thermal design is highly recommended. LEDiL has no liability for direct, indirect or consecutive damages arising from the LEDiL products being used outside of the recommended temperature range.

MATERIALS:

As part of our continuous research and improvement processes, and to ensure the best possible quality and availability of our products, LEDiL reserves the right to change material grades without notice.

PRODUCT DATA USER AGREEMENT AND DISCLAIMER:

The measured data in the provided downloadable LEDiL Product Datasheets and Mechanical 2D-Drawings is rounded and provided as reference for planning. LEDiL Oy's optical specifications have been verified by conducting performance testing of the products in accordance with the company's quality system. The reported data are averaged results of multiple measurements with typical variation. LEDiL Oy reserves the right to without prior notification make changes and improvements to its products.

LEDiL Oy assumes neither warranty, nor guarantee nor any other liability of any kind for the contents and correctness of the provided data. The provided data has been generated with highest diligence but the provided data may in reality not represent the complete possible variation range of all intrinsic parameters. Therefore, in certain cases a deviation from the provided data could occur.

LEDiL Oy reserves the right to undertake technical changes of its products without further notification which could lead to changes in the provided data. LEDiL Oy assumes no liability of any kind for the possible deviation from any provided data or any other damage resulting from the usage of the provided data.

The user agrees to this disclaimer and user agreement with the download or usage of the provided files.

LEDiL Oy

Joensuunkatu 13
FI-24240 SALO
Finland

LEDiL Inc.

228 West Page Street
Suite D
Sycamore IL 60178
USA

Ledil Optics Technology (Shenzhen) Co., Ltd.

405 , Block B
Casic Motor Building
Shenzhen 518057
P.R.CHINA

Local sales and technical support

[www.ledil.com/
where_to_buy](http://www.ledil.com/where_to_buy)

Shipping locations

Salo, Finland
Hong Kong, China

Distribution Partners

[www.ledil.com/
where_to_buy](http://www.ledil.com/where_to_buy)