

LENINA-S

~19° spot beam

SPECIFICATION:

Dimensions	Ø 74.0 mm
Height	40 mm
ROHS compliant	yes ⓘ

MATERIALS:

Component	Type	Material	Colour	Finish	Coating
LENINA-S	Reflector	PC	metal		lacquer







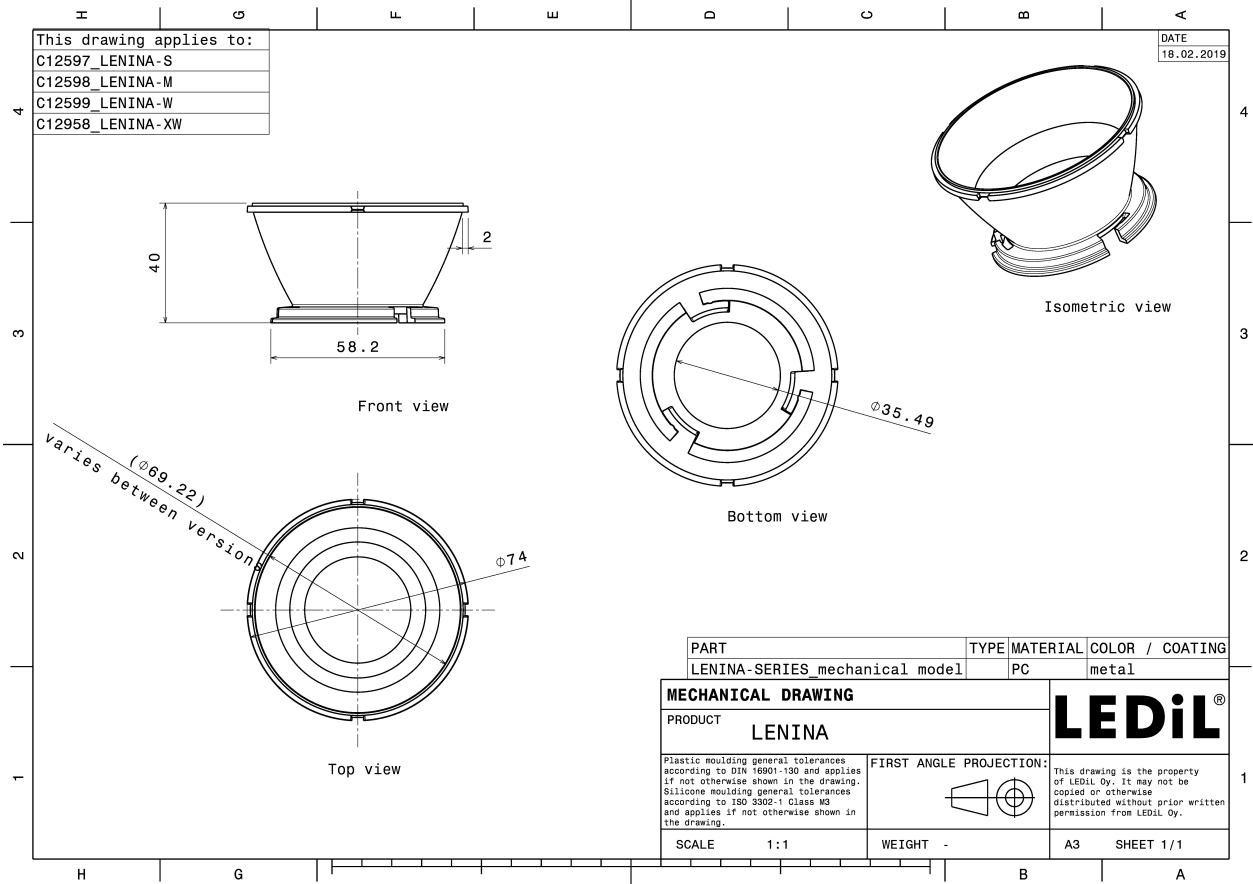

ORDERING INFORMATION:

Component	Qty in box	MOQ	MPQ	Box weight (kg)
C12597_LENINA-S » Box size: 476 x 273 x 197 mm	60	120	60	2.0

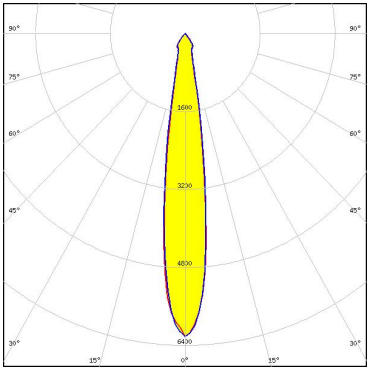

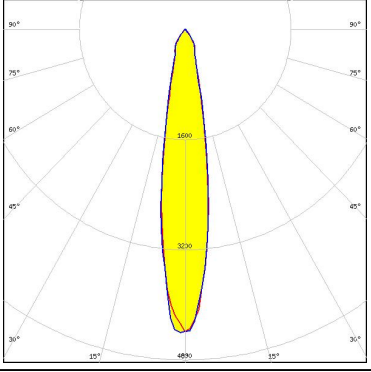

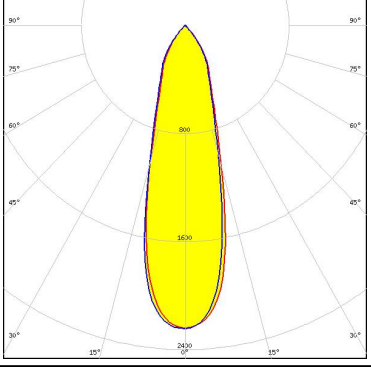

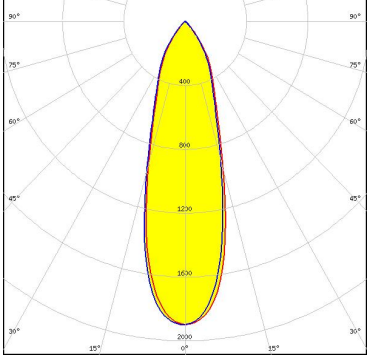

See also our general installation guide: www.ledil.com/installation_guide

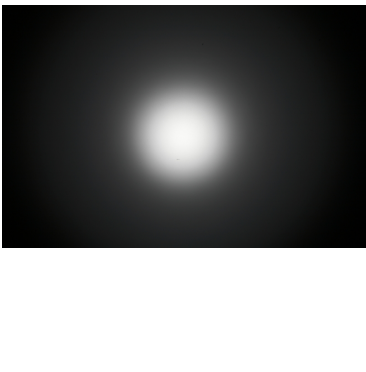
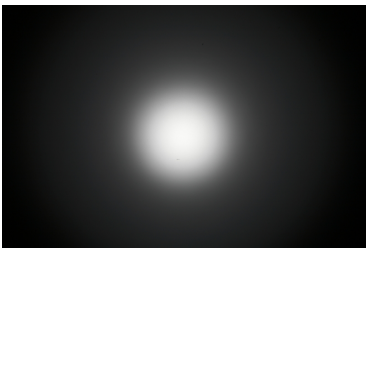
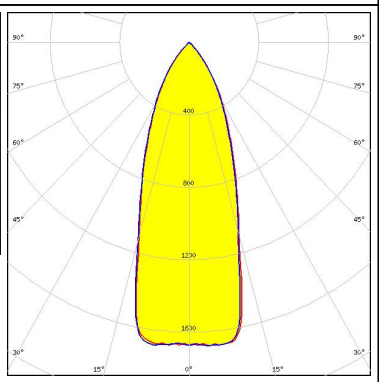

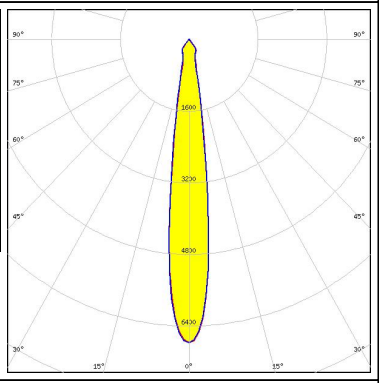

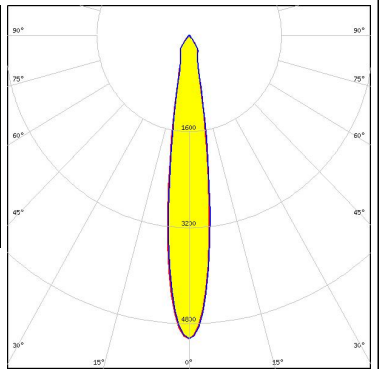
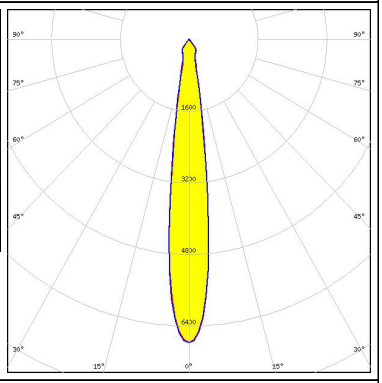

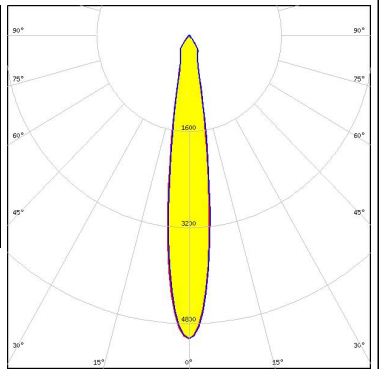
OPTICAL RESULTS (MEASURED):

<p></p> <p>LED BXRA ES Rectangle FWHM / FWTM 15.0° / 36.0° Efficiency 88 % LEDs/each optic 1 Light colour White Required components: C12153_LENINA-STD-BASE-BXRA</p>	
<p></p> <p>LED BXRA ES Rectangle FWHM / FWTM 20.0° / 60.0° Efficiency 80 % LEDs/each optic 1 Light colour White Required components: C12153_LENINA-STD-BASE-BXRA C12606_LENINA-DL</p>	
<p></p> <p>LED BXRA RS FWHM / FWTM 28.0° / 70.0° Efficiency 89 % Peak intensity 2.3 cd/lm LEDs/each optic 1 Light colour White Required components: C12229_LENINA-STD-BASE-RS</p>	
<p></p> <p>LED BXRA RS FWHM / FWTM 32.0° / 72.0° Efficiency 81 % Peak intensity 2 cd/lm LEDs/each optic 1 Light colour White Required components: C12229_LENINA-STD-BASE-RS C12606_LENINA-DL</p>	

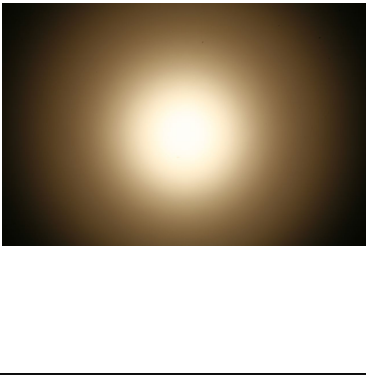
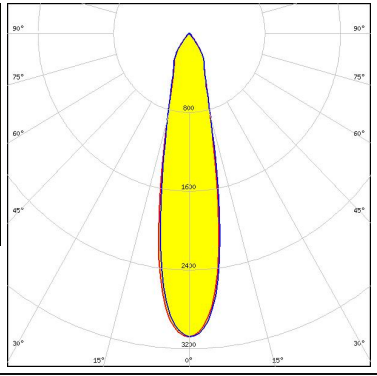
OPTICAL RESULTS (MEASURED):

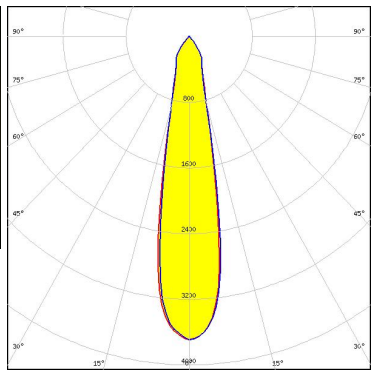
<p></p> <p>LED V10 Gen6 FWHM / FWTM 13.0° / 30.0° Efficiency 83 % Peak intensity 7.2 cd/lm LEDs/each optic 1 Light colour White</p> <p>Required components: C13186_LENINA-STD-BASE-CXA15 C12606_LENINA-DL</p>		
<p></p> <p>LED Vero SE 29 FWHM / FWTM 38.0° / 76.0° Efficiency 92 % Peak intensity 1.7 cd/lm LEDs/each optic 1 Light colour White</p> <p>Required components: C15083_LENINA-STD-BASE-VERO29</p>		
<p></p> <p>LED VERO13 FWHM / FWTM 15.0° / 29.0° Efficiency 91 % Peak intensity 6.8 cd/lm LEDs/each optic 1 Light colour White</p> <p>Required components: C13868_LENINA-STD-BASE-VERO13-18</p>		
<p></p> <p>LED VERO13 FWHM / FWTM 16.0° / 35.0° Efficiency 86 % Peak intensity 5.1 cd/lm LEDs/each optic 1 Light colour White</p> <p>Required components: C13868_LENINA-STD-BASE-VERO13-18 C12606_LENINA-DL</p>		

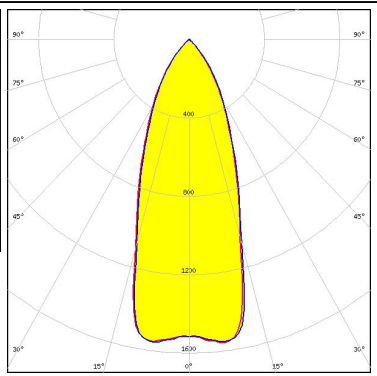
OPTICAL RESULTS (MEASURED):

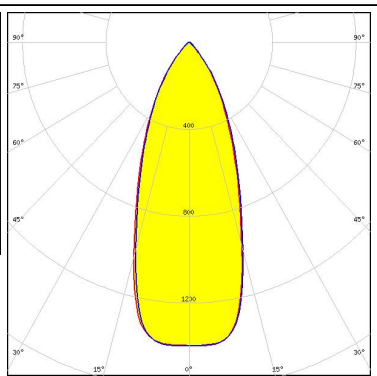
<p>bridgelux.</p> <p>LED VERO18 FWHM / FWTM 22.0° / 60.0° Efficiency 86 % Peak intensity 3.1 cd/m LEDs/each optic 1 Light colour White</p> <p>Required components: C13868_LENINA-STD-BASE-VERO13-18 C12606_LENINA-DL</p>		
<p>bridgelux.</p> <p>LED VERO18 FWHM / FWTM 21.0° / 52.0° Efficiency 90 % Peak intensity 3.7 cd/m LEDs/each optic 1 Light colour White</p> <p>Required components: C13868_LENINA-STD-BASE-VERO13-18</p>		
<p>bridgelux.</p> <p>LED VERO29 FWHM / FWTM 40.0° / 78.0° Efficiency 89 % Peak intensity 1.6 cd/m LEDs/each optic 1 Light colour White</p> <p>Required components: C13867_LENINA-STD-BASE-VERO29</p>		
<p>bridgelux.</p> <p>LED VERO29 FWHM / FWTM 40.0° / 78.0° Efficiency 85 % Peak intensity 1.5 cd/m LEDs/each optic 1 Light colour White</p> <p>Required components: C13867_LENINA-STD-BASE-VERO29 C12606_LENINA-DL</p>		

OPTICAL RESULTS (MEASURED):

CITIZEN

LED CL-L340
FWHM / FWTM 17.0° / 44.0°
Efficiency 88 %
LEDs/each optic 1
Light colour White
Required components:
C11995_LENINA-STD-BASE-CL340

CITIZEN

LED CL-L340
FWHM / FWTM 22.0° / 62.0°
Efficiency 80 %
LEDs/each optic 1
Light colour White
Required components:
C11995_LENINA-STD-BASE-CL340
C12606_LENINA-DL

CITIZEN

LED CLL02x/CLU02x (LES10)
FWHM / FWTM 11.0° / 22.0°
Efficiency 91 %
Peak intensity 10.9 cd/lm
LEDs/each optic 1
Light colour White
Required components:
C13868_LENINA-STD-BASE-VERO13-18
Bender Wirth: 434 Typ L1

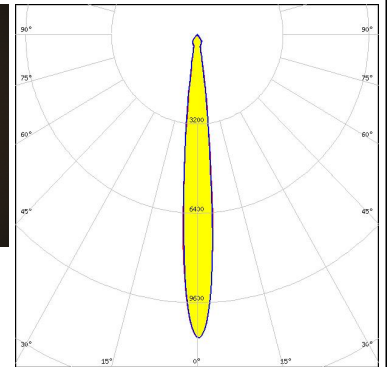

CITIZEN

LED CLL02x/CLU02x (LES10)
FWHM / FWTM 13.0° / 28.0°
Efficiency 86 %
Peak intensity 6.9 cd/lm
LEDs/each optic 1
Light colour White
Required components:
C13868_LENINA-STD-BASE-VERO13-18
C12606_LENINA-DL
Bender Wirth: 434 Typ L1

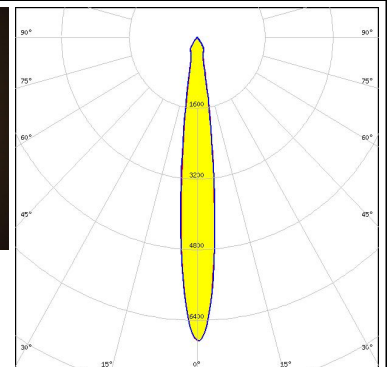
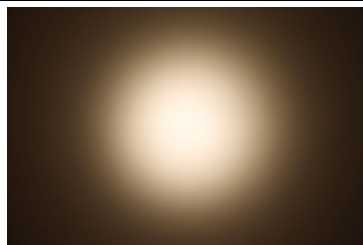

OPTICAL RESULTS (MEASURED):

CITIZEN

LED CLL03x/CLU03x
 FWHM / FWTM 16.0° / 36.0°
 Efficiency 93 %
 Peak intensity 5.4 cd/lm
 LEDs/each optic 1
 Light colour White
 Required components:
 C12691_LENINA-STD-BASE-CLL030

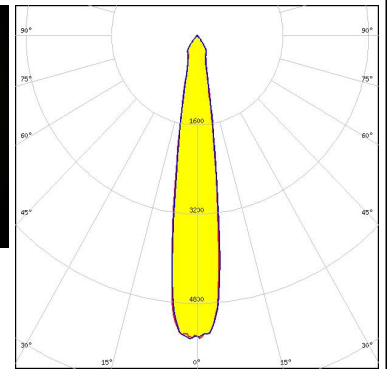

CITIZEN

LED CLL03x/CLU03x
 FWHM / FWTM 17.0° / 43.0°
 Efficiency 87 %
 Peak intensity 4.5 cd/lm
 LEDs/each optic 1
 Light colour White
 Required components:
 C12691_LENINA-STD-BASE-CLL030
 C12606_LENINA-DL

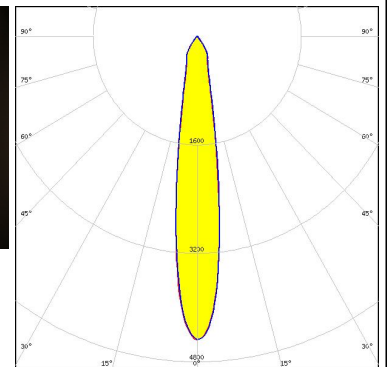

CITIZEN

LED CLL03x/CLU03x
 FWHM / FWTM 17.0° / 41.0°
 Efficiency 87 %
 Peak intensity 4.5 cd/lm
 LEDs/each optic 1
 Light colour White
 Required components:
 C13868_LENINA-STD-BASE-VERO13-18
 C12606_LENINA-DL
 Bender Wirth: 433 Typ L1

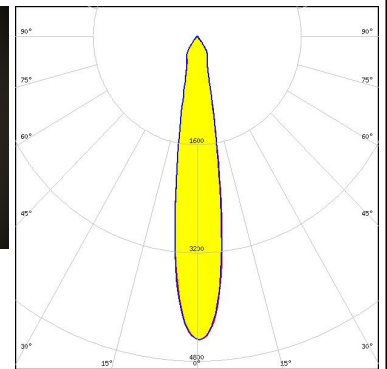

CITIZEN

LED CLL03x/CLU03x
 FWHM / FWTM 15.0° / 33.0°
 Efficiency 91 %
 Peak intensity 6.1 cd/lm
 LEDs/each optic 1
 Light colour White
 Required components:
 C12691_LENINA-STD-BASE-CLL030

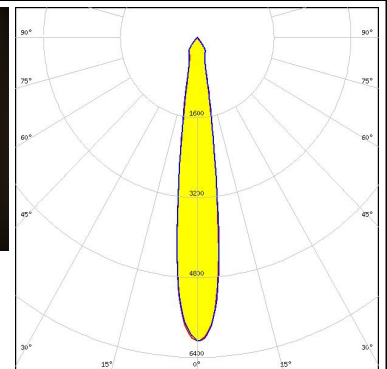

OPTICAL RESULTS (MEASURED):

CITIZEN

LED CLL03x/CLU03x
 FWHM / FWTM 17.0° / 34.0°
 Efficiency 91 %
 Peak intensity 5.5 cd/lm
 LEDs/each optic 1
 Light colour White
 Required components:
 C13868_LENINA-STD-BASE-VERO13-18
 Bender Wirth: 433 Typ L1

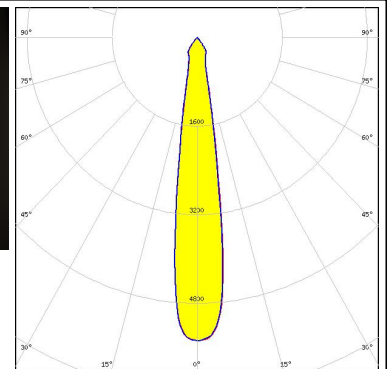

CITIZEN

LED CLL04x/CLU04x
 FWHM / FWTM 25.0° / 67.0°
 Efficiency 87 %
 Peak intensity 2.4 cd/lm
 LEDs/each optic 1
 Light colour White
 Required components:
 C12606_LENINA-DL
 IDEAL: 50-2204CT + 50-2100LN

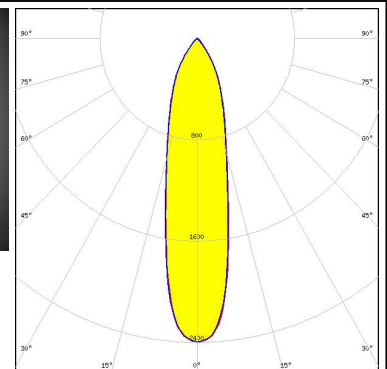

CITIZEN

LED CLL04x/CLU04x
 FWHM / FWTM 26.0° / 68.0°
 Efficiency 79 %
 Peak intensity 2.2 cd/lm
 LEDs/each optic 1
 Light colour White
 Required components:
 C12606_LENINA-DL
 A.A.G. STUCCHI: 8102-G2 + S-8000-12

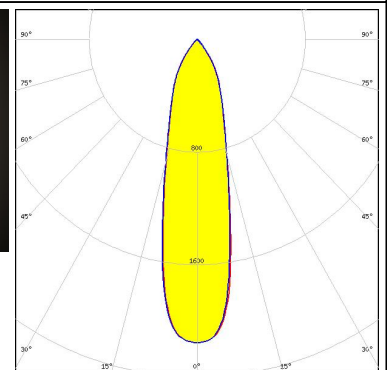
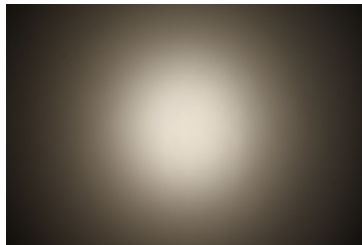

CITIZEN

LED CLL04x/CLU04x
 FWHM / FWTM 30.0° / 70.0°
 Efficiency 78 %
 Peak intensity 1.9 cd/lm
 LEDs/each optic 1
 Light colour White
 Required components:
 C12692_LENINA-STD-BASE-CLL040
 C12606_LENINA-DL

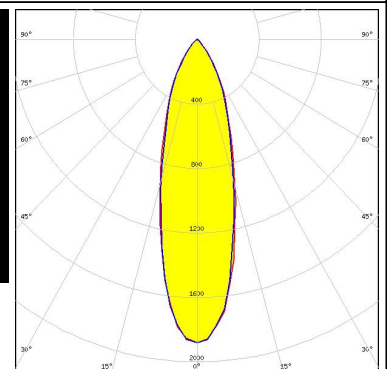
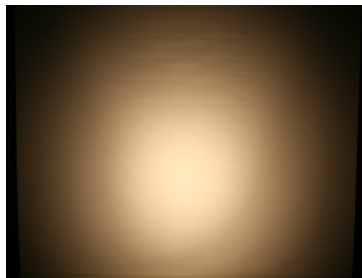

OPTICAL RESULTS (MEASURED):

CITIZEN

LED CLL04x/CLU04x
 FWHM / FWTM 27.0° / 69.0°
 Efficiency 86 %
 Peak intensity 2.2 cd/m
 LEDs/each optic 1
 Light colour White
 Required components:
 C13867_LENINA-STD-BASE-VERO29
 C12606_LENINA-DL
 Bender Wirth: 431 Typ L3

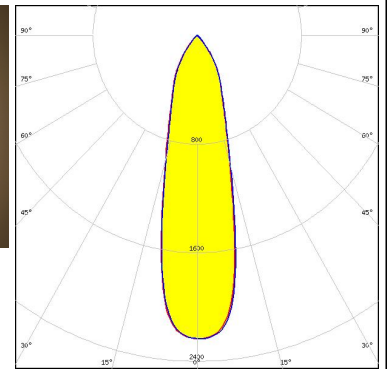
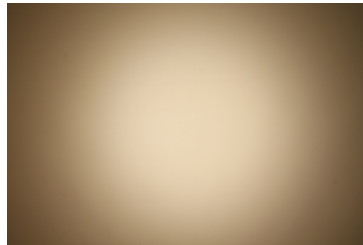

CITIZEN

LED CLL04x/CLU04x
 FWHM / FWTM 23.0° / 66.0°
 Efficiency 90 %
 Peak intensity 2.7 cd/m
 LEDs/each optic 1
 Light colour White
 Required components:
 IDEAL: 50-2204CT + 50-2100LN

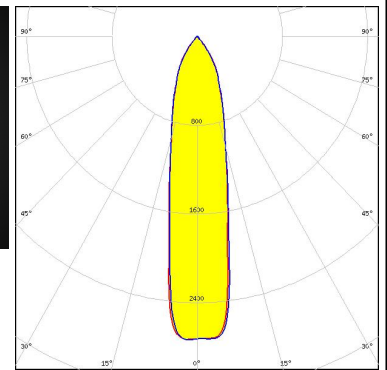
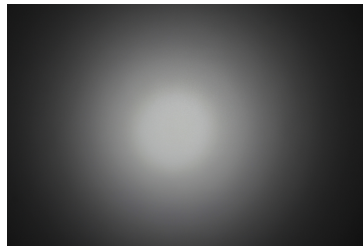

CITIZEN

LED CLL04x/CLU04x
 FWHM / FWTM 26.0° / 68.0°
 Efficiency 91 %
 Peak intensity 2.6 cd/m
 LEDs/each optic 1
 Light colour White
 Required components:
 C13867_LENINA-STD-BASE-VERO29
 Bender Wirth: 431 Typ L3

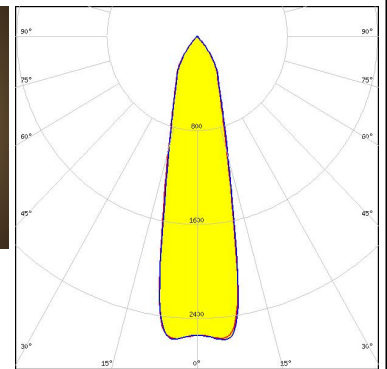
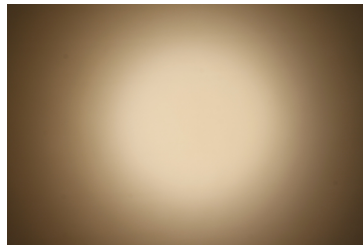

CITIZEN

LED CLL04x/CLU04x
 FWHM / FWTM 24.0° / 67.0°
 Efficiency 83 %
 Peak intensity 2.5 cd/m
 LEDs/each optic 1
 Light colour White
 Required components:
 A.A.G. STUCCHI: 8102-G2 + S-8000-12

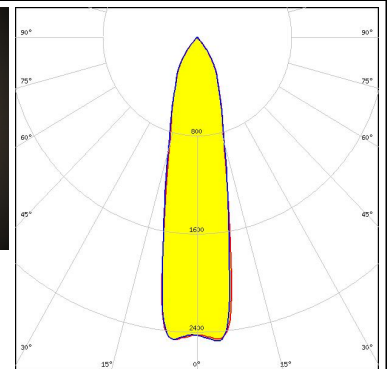
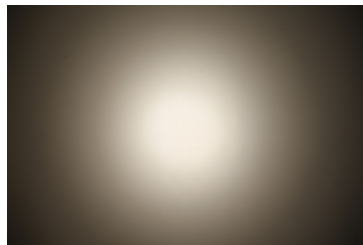

OPTICAL RESULTS (MEASURED):

CITIZEN

LED CLL04x/CLU04x
 FWHM / FWTM 26.0° / 68.0°
 Efficiency 86 %
 Peak intensity 2.6 cd/lm
 LEDs/each optic 1
 Light colour White
 Required components:
 C12692_LENINA-STD-BASE-CLL040

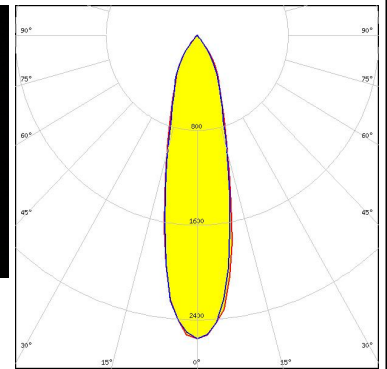
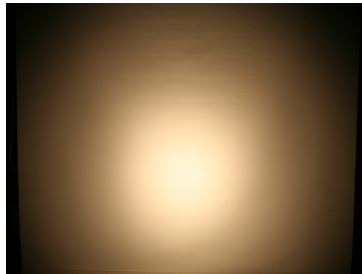

CITIZEN

LED CLU700/701/702/703
 FWHM / FWTM 11.0° / 23.0°
 Efficiency 86 %
 Peak intensity 9.1 cd/lm
 LEDs/each optic 1
 Light colour White
 Required components:
 C13868_LENINA-STD-BASE-VERO13-18
 C12606_LENINA-DL
 Bender Wirth: 434 Typ L1

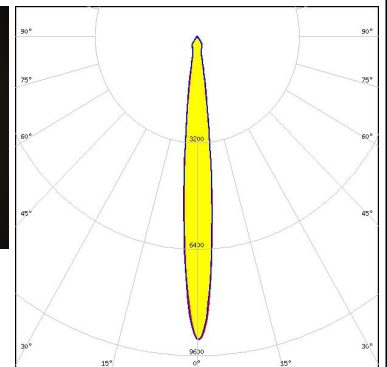

CITIZEN

LED CLU700/701/702/703
 FWHM / FWTM 8.0° / 17.0°
 Efficiency 91 %
 Peak intensity 17.8 cd/lm
 LEDs/each optic 1
 Light colour White
 Required components:
 C13868_LENINA-STD-BASE-VERO13-18
 Bender Wirth: 434 Typ L1

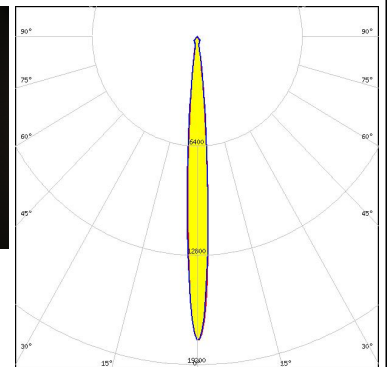

CITIZEN

LED CLU710/711
 FWHM / FWTM 12.0° / 26.0°
 Efficiency 89 %
 Peak intensity 7.4 cd/lm
 LEDs/each optic 1
 Light colour White
 Required components:
 C12691_LENINA-STD-BASE-CLL030
 C12606_LENINA-DL

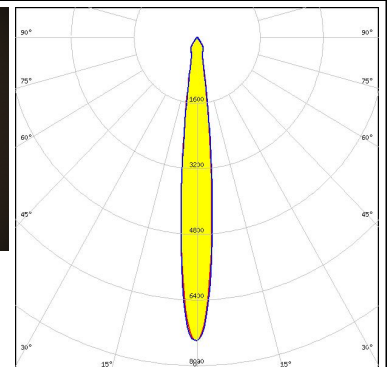

OPTICAL RESULTS (MEASURED):

CITIZEN

LED CLU710/711
 FWHM / FWTM 10.0° / 20.0°
 Efficiency 94 %
 Peak intensity 12.3 cd/lm
 LEDs/each optic 1
 Light colour White
 Required components:
 C12691_LENINA-STD-BASE-CLL030

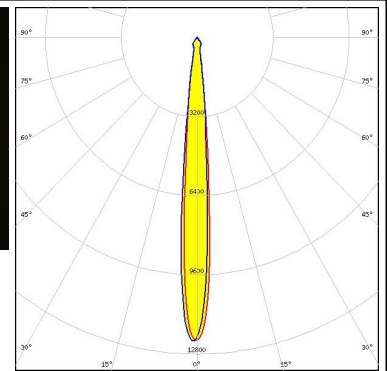

CITIZEN

LED CLU720/721/723
 FWHM / FWTM 13.0° / 30.0°
 Efficiency 84 %
 Peak intensity 5.8 cd/lm
 LEDs/each optic 1
 Light colour White
 Required components:
 C12691_LENINA-STD-BASE-CLL030
 C12606_LENINA-DL

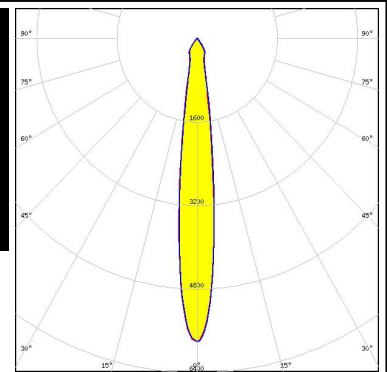
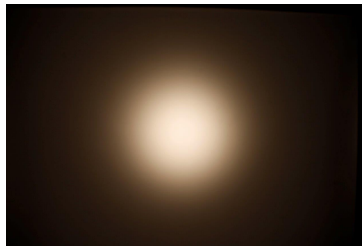

CITIZEN

LED CLU720/721/723
 FWHM / FWTM 12.0° / 24.0°
 Efficiency 89 %
 Peak intensity 8.2 cd/lm
 LEDs/each optic 1
 Light colour White
 Required components:
 C12691_LENINA-STD-BASE-CLL030

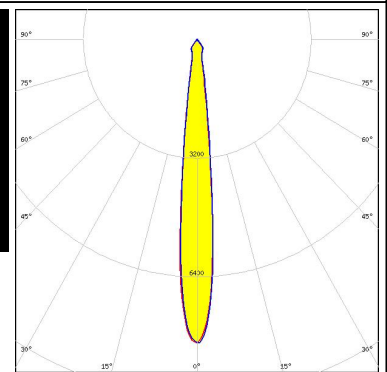
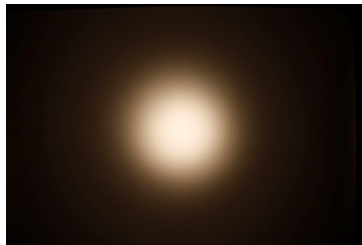

CITIZEN

LED CLU730/731/733
 FWHM / FWTM 15.0° / 39.0°
 Efficiency 85 %
 Peak intensity 4.6 cd/lm
 LEDs/each optic 1
 Light colour White
 Required components:
 C12692_LENINA-STD-BASE-CLL040
 C12606_LENINA-DL

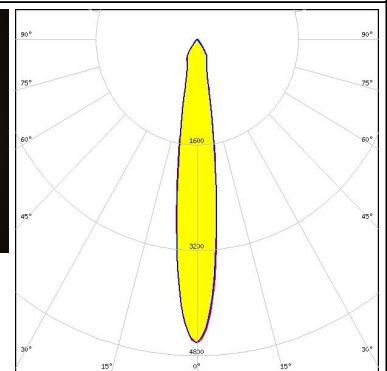
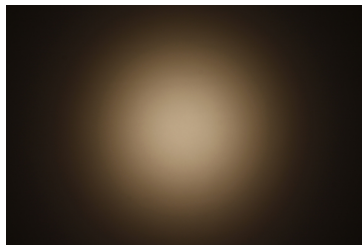

OPTICAL RESULTS (MEASURED):

CITIZEN

LED CLU730/731/733
 FWHM / FWTM 14.0° / 30.0°
 Efficiency 94 %
 Peak intensity 6.5 cd/lm
 LEDs/each optic 1
 Light colour White
 Required components:
 C12692_LENINA-STD-BASE-CLL040

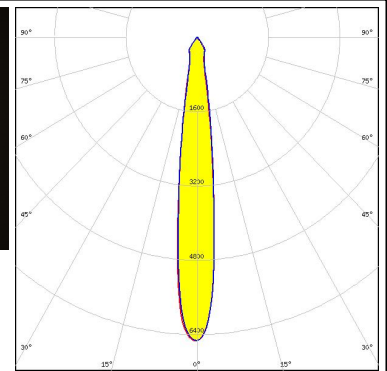

LED CMA1840
 FWHM / FWTM 25.0° / 70.0°
 Efficiency 92 %
 Peak intensity 2.7 cd/lm
 LEDs/each optic 1
 Light colour White
 Required components:
 C14146_LENINA-STD-BASE-CXA18

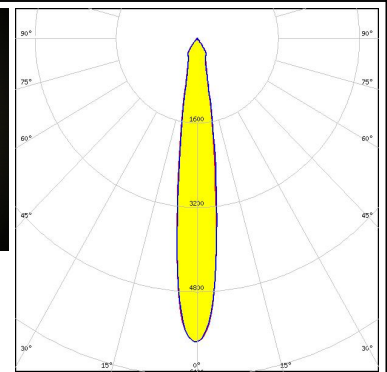
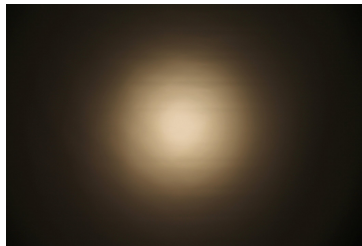

LED CMA1840
 FWHM / FWTM 15.0° / 37.0°
 Efficiency 92 %
 Peak intensity 5.7 cd/lm
 LEDs/each optic 1
 Light colour White
 Required components:
 C14146_LENINA-STD-BASE-CXA18

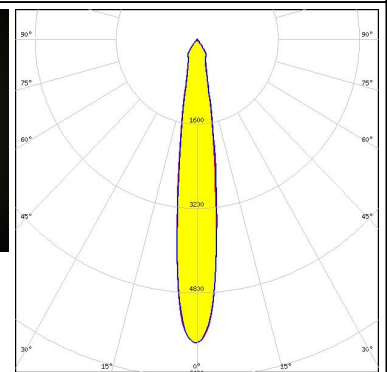
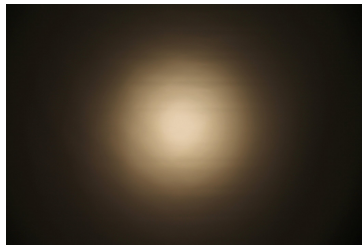

LED CMA2550
 FWHM / FWTM 21.0° / 63.0°
 Efficiency 92 %
 Peak intensity 3.4 cd/lm
 LEDs/each optic 1
 Light colour White
 Required components:
 C13324_LENINA-STD-BASE-CXA25

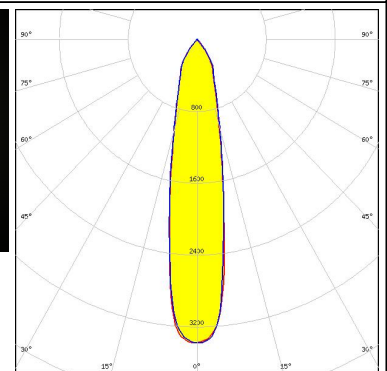
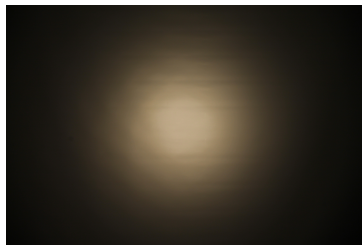

OPTICAL RESULTS (MEASURED):



LED CMT14xx
 FWHM / FWTM 11.0° / 24.0°
 Efficiency 92 %
 Peak intensity 9.7 cd/m
 LEDs/each optic 1
 Light colour White
 Required components:
 C13868_LENINA-STD-BASE-VERO13-18
 Bender Wirth: 434 Typ L1

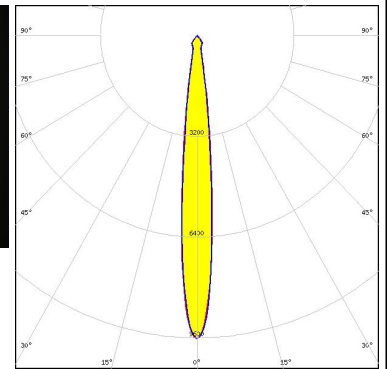

LED CMT19xx
 FWHM / FWTM 16.0° / 37.0°
 Efficiency 92 %
 Peak intensity 5.3 cd/m
 LEDs/each optic 1
 Light colour White
 Required components:
 C12691_LENINA-STD-BASE-CLL030

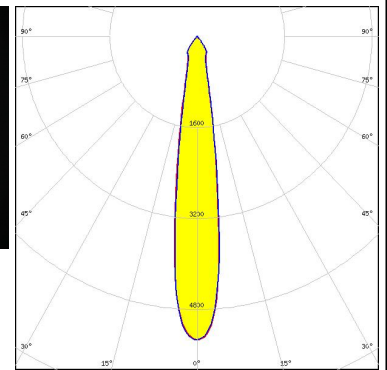

LED CMT19xx
 FWHM / FWTM 17.0° / 37.0°
 Efficiency 92 %
 Peak intensity 5.3 cd/m
 LEDs/each optic 1
 Light colour White
 Required components:
 C13868_LENINA-STD-BASE-VERO13-18
 Bender Wirth: 477 Typ L1

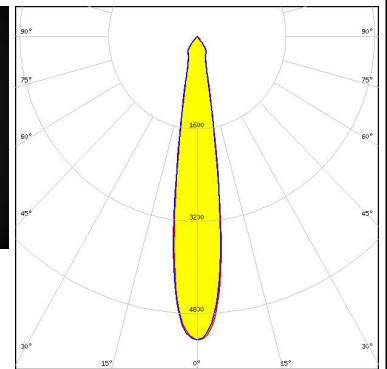

LED CMT28xx
 FWHM / FWTM 26.0° / 68.0°
 Efficiency 92 %
 Peak intensity 2.6 cd/m
 LEDs/each optic 1
 Light colour White
 Required components:
 C12692_LENINA-STD-BASE-CLL040

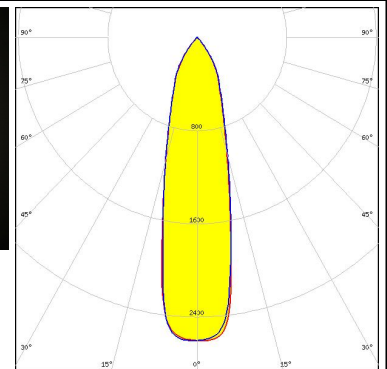
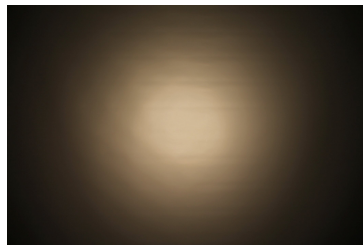

OPTICAL RESULTS (MEASURED):



LED CMT28xx
FWHM / FWTM 26.0° / 68.0°
Efficiency 92 %
Peak intensity 2.6 cd/lm
LEDs/each optic 1
Light colour White

Required components:

C13867_LENINA-STD-BASE-VERO29
Bender Wirth: 471 Typ L3

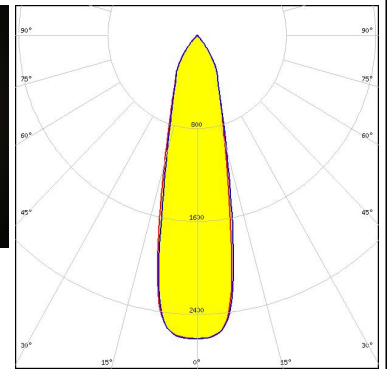
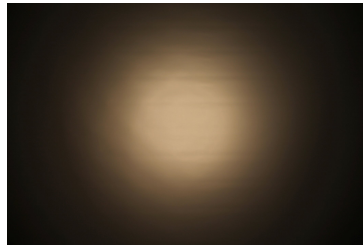

LED CXA/B 15xx
FWHM / FWTM 13.0° / 27.0°
Efficiency 87 %
Peak intensity 7.2 cd/lm
LEDs/each optic 1
Light colour White

Required components:

C13868_LENINA-STD-BASE-VERO13-18
C12606_LENINA-DL
Bender Wirth: 441 Typ L1

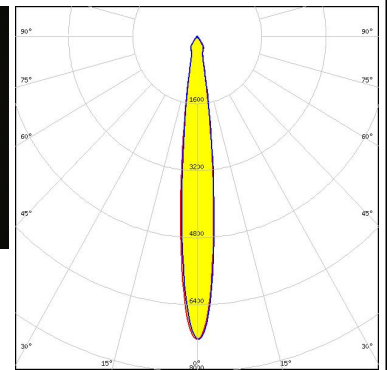
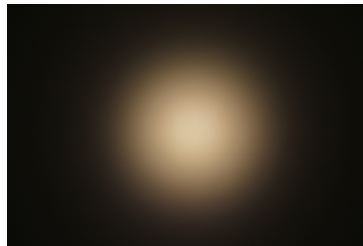

LED CXA/B 15xx
FWHM / FWTM 12.0° / 26.0°
Efficiency 86 %
Peak intensity 7.6 cd/lm
LEDs/each optic 1
Light colour White

Required components:

C13186_LENINA-STD-BASE-CXA15
C12606_LENINA-DL

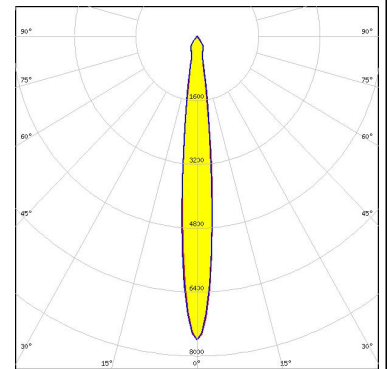

LED CXA/B 15xx
FWHM / FWTM 10.0° / 21.0°
Efficiency 91 %
Peak intensity 11.9 cd/lm
LEDs/each optic 1
Light colour White

Required components:

C13868_LENINA-STD-BASE-VERO13-18
Bender Wirth: 441 Typ L1

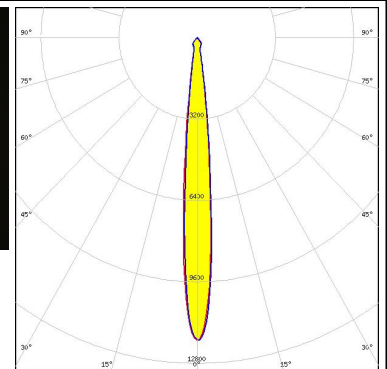

OPTICAL RESULTS (MEASURED):



LED CXA/B 15xx
 FWHM / FWTM 10.0° / 20.0°
 Efficiency 91 %
 Peak intensity 12.1 cd/lm
 LEDs/each optic 1
 Light colour White
 Required components:
 C13186_LENINA-STD-BASE-CXA15

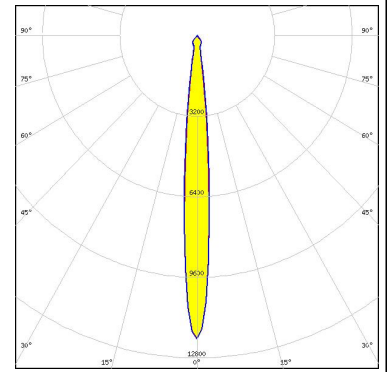

LED CXA/B 1816 & CXA/B 1820 & CXA 1850
 FWHM / FWTM 15.0° / 32.0°
 Efficiency 88 %
 Peak intensity 5.9 cd/lm
 LEDs/each optic 1
 Light colour White
 Required components:
 C13868_LENINA-STD-BASE-VERO13-18
 C12606_LENINA-DL
 Bender Wirth: 437 Typ L1

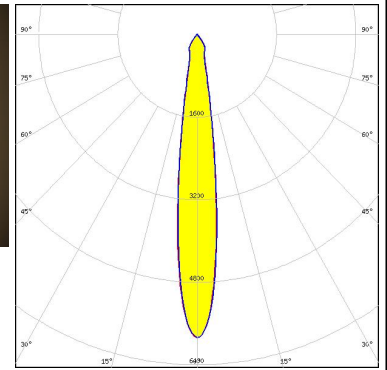

LED CXA/B 1816 & CXA/B 1820 & CXA 1850
 FWHM / FWTM 12.0° / 28.0°
 Efficiency 92 %
 Peak intensity 9.6 cd/lm
 LEDs/each optic 1
 Light colour White
 Required components:
 C14146_LENINA-STD-BASE-CXA18



LED CXA/B 1816 & CXA/B 1820 & CXA 1850
 FWHM / FWTM 13.0° / 26.0°
 Efficiency 92 %
 Peak intensity 8 cd/lm
 LEDs/each optic 1
 Light colour White
 Required components:
 C13868_LENINA-STD-BASE-VERO13-18
 Bender Wirth: 437 Typ L1

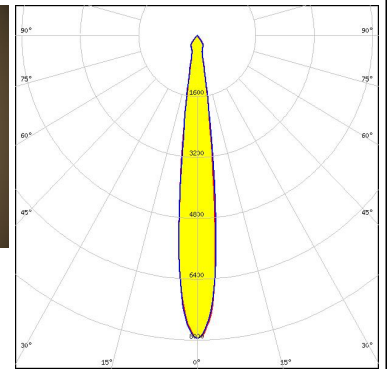

OPTICAL RESULTS (MEASURED):



LED CXA/B 1830
 FWHM / FWTM 16.0° / 33.0°
 Efficiency 93 %
 Peak intensity 5.8 cd/m
 LEDs/each optic 1
 Light colour White
 Required components:
 C13868_LENINA-STD-BASE-VERO13-18
 Bender Wirth: 437 Typ L1

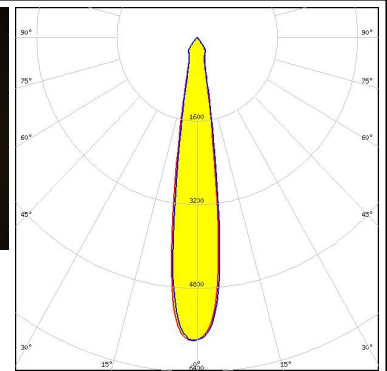

LED CXA/B 1830
 FWHM / FWTM 18.0° / 41.0°
 Efficiency 88 %
 Peak intensity 4.5 cd/m
 LEDs/each optic 1
 Light colour White
 Required components:
 C13868_LENINA-STD-BASE-VERO13-18
 C12606_LENINA-DL
 Bender Wirth: 437 Typ L1

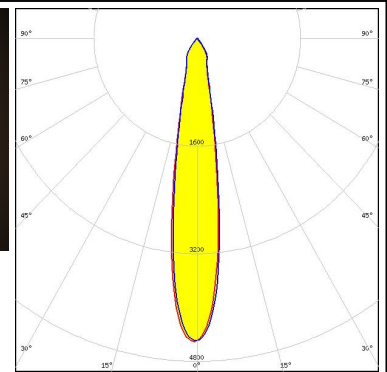

LED CXA/B 25xx
 FWHM / FWTM 23.0° / 65.0°
 Efficiency 78 %
 Peak intensity 2.7 cd/m
 LEDs/each optic 1
 Light colour White
 Required components:
 C13324_LENINA-STD-BASE-CXA25
 C12606_LENINA-DL

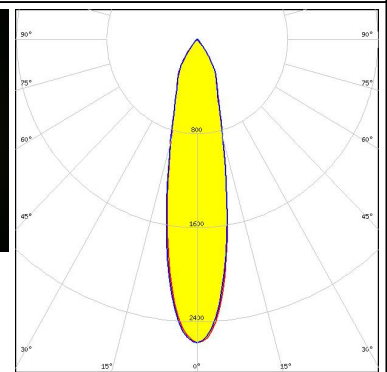
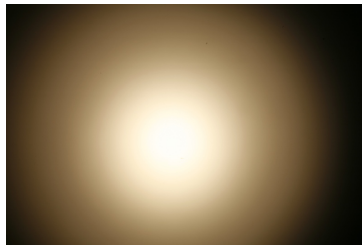

LED CXA/B 25xx
 FWHM / FWTM 22.0° / 63.0°
 Efficiency 86 %
 Peak intensity 3.2 cd/m
 LEDs/each optic 1
 Light colour White
 Required components:
 C13324_LENINA-STD-BASE-CXA25

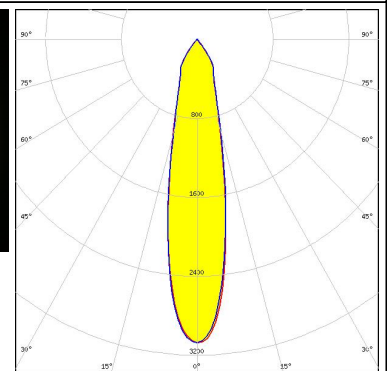
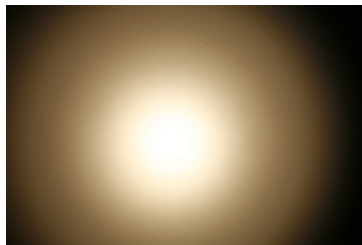

OPTICAL RESULTS (MEASURED):



LED CXA2011
 FWHM / FWTM 16.0° / 38.0°
 Efficiency 88 %
 Peak intensity 4.4 cd/lm
 LEDs/each optic 1
 Light colour White
 Required components:
 C12105_LENINA-STD-BASE-CXA20

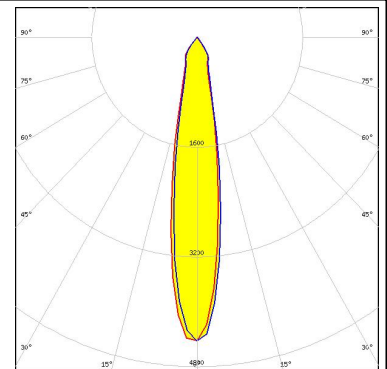

LED CXA2011
 FWHM / FWTM 20.0° / 60.0°
 Efficiency 80 %
 Peak intensity 3.5 cd/lm
 LEDs/each optic 1
 Light colour White
 Required components:
 C12105_LENINA-STD-BASE-CXA20
 C12606_LENINA-DL

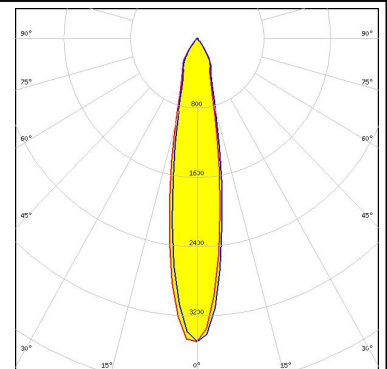

LED CHI3030 19W
 FWHM / FWTM 25.0° / 68.0°
 Efficiency 91 %
 Peak intensity 2.6 cd/lm
 LEDs/each optic 1
 Light colour White
 Required components:
 C13867_LENINA-STD-BASE-VERO29
 C12606_LENINA-DL
 Bender Wirth: 468 Typ L3

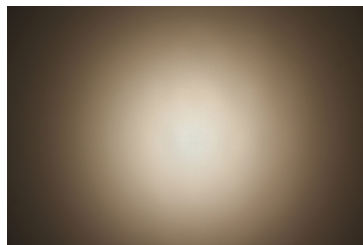

LED CHI3030 29W
 FWHM / FWTM 33.0° / 76.0°
 Efficiency 87 %
 Peak intensity 1.7 cd/lm
 LEDs/each optic 1
 Light colour White
 Required components:
 C13867_LENINA-STD-BASE-VERO29
 C12606_LENINA-DL
 Bender Wirth: 468 Typ L3

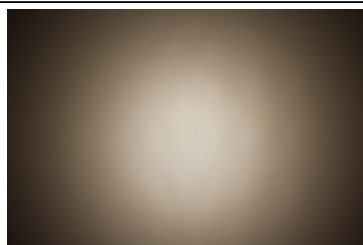

OPTICAL RESULTS (MEASURED):

LUMILEDS

LED LUXEON CoB 1202/1203
 FWHM / FWTM 11.0° / 21.0°
 Efficiency 92 %
 Peak intensity 11.5 cd/lm
 LEDs/each optic 1
 Light colour White
 Required components:
 C13868_LENINA-STD-BASE-VERO13-18
 Bender Wirth: 438 Typ L1

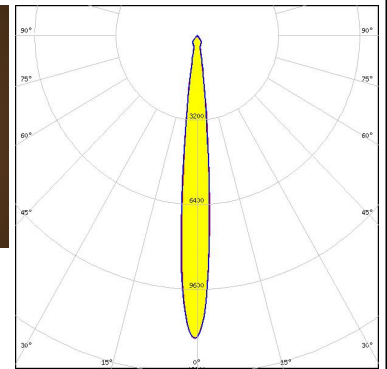

LUMILEDS

LED LUXEON CoB 1202/1203
 FWHM / FWTM 13.0° / 27.0°
 Efficiency 88 %
 Peak intensity 7.5 cd/lm
 LEDs/each optic 1
 Light colour White
 Required components:
 C13868_LENINA-STD-BASE-VERO13-18
 C12606_LENINA-DL
 Bender Wirth: 438 Typ L1

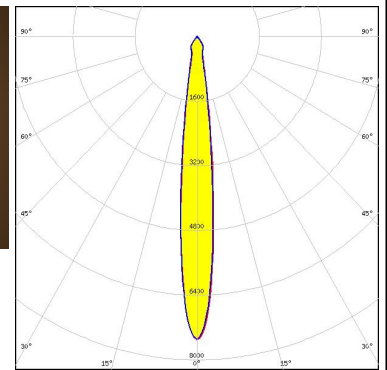

LUMILEDS

LED LUXEON CoB 1204/1205
 FWHM / FWTM 18.0° / 42.0°
 Efficiency 88 %
 Peak intensity 4.5 cd/lm
 LEDs/each optic 1
 Light colour White
 Required components:
 C12292_LENINA-STD-BASE-MEZ

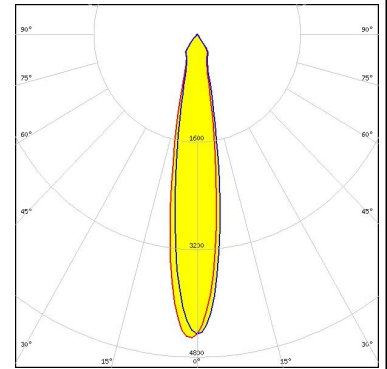

LUMILEDS

LED LUXEON CoB 1204/1205
 FWHM / FWTM 19.0° / 53.0°
 Efficiency 84 %
 Peak intensity 3.6 cd/lm
 LEDs/each optic 1
 Light colour White
 Required components:
 C12292_LENINA-STD-BASE-MEZ
 C12606_LENINA-DL

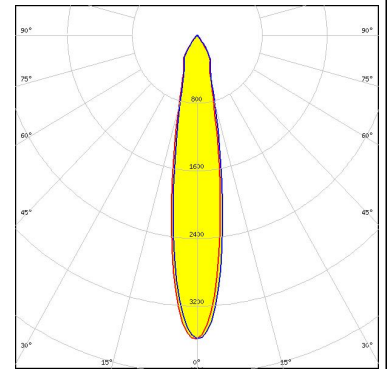

OPTICAL RESULTS (MEASURED):

LUMILEDS

LED LUXEON CoB 1204HD
 FWHM / FWTM 10.0° / 22.0°
 Efficiency 92 %
 Peak intensity 10.9 cd/lm
 LEDs/each optic 1
 Light colour White
 Required components:
 C11981_LENINA-STD-BASE-COB-L110

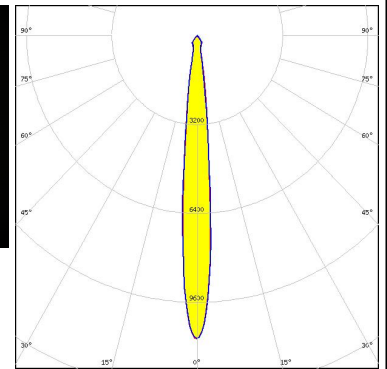

LUMILEDS

LED LUXEON CoB 1205HD
 FWHM / FWTM 12.0° / 27.0°
 Efficiency 92 %
 Peak intensity 8.2 cd/lm
 LEDs/each optic 1
 Light colour White
 Required components:
 C11981_LENINA-STD-BASE-COB-L110

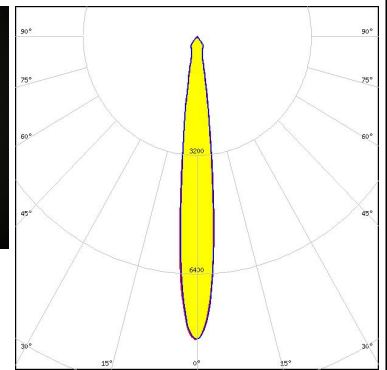
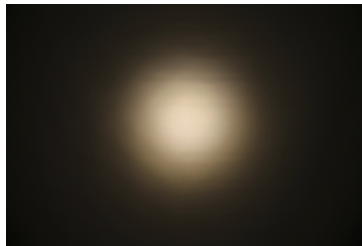

LUMILEDS

LED LUXEON CoB 1208
 FWHM / FWTM 20.0° / 50.0°
 Efficiency 89 %
 Peak intensity 3.9 cd/lm
 LEDs/each optic 1
 Light colour White
 Required components:
 C12292_LENINA-STD-BASE-MEZ

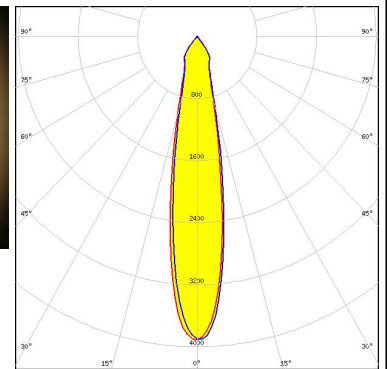

LUMILEDS

LED LUXEON CoB 1208
 FWHM / FWTM 21.0° / 61.0°
 Efficiency 85 %
 Peak intensity 3.2 cd/lm
 LEDs/each optic 1
 Light colour White
 Required components:
 C12292_LENINA-STD-BASE-MEZ
 C12606_LENINA-DL

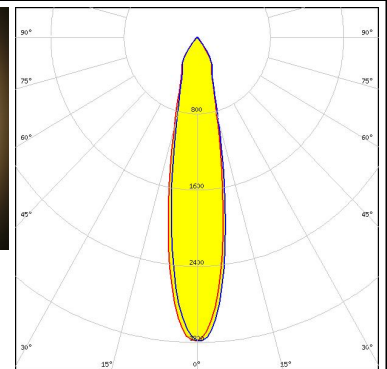

OPTICAL RESULTS (MEASURED):

LUMILEDS

LED LUXEON CoB 1211
 FWHM / FWTM 22.0° / 61.0°
 Efficiency 92 %
 Peak intensity 3.4 cd/m
 LEDs/each optic 1
 Light colour White
 Required components:
 C13867_LENINA-STD-BASE-VERO29
 Bender Wirth: 431 Typ L3

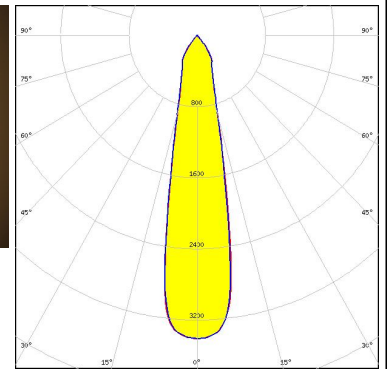

LUMILEDS

LED LUXEON CoB 1211
 FWHM / FWTM 23.0° / 64.0°
 Efficiency 86 %
 Peak intensity 2.8 cd/m
 LEDs/each optic 1
 Light colour White
 Required components:
 C13867_LENINA-STD-BASE-VERO29
 C12606_LENINA-DL
 Bender Wirth: 431 Typ L3

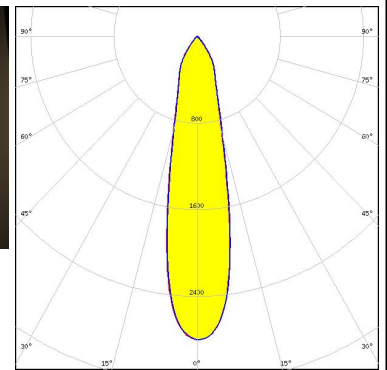
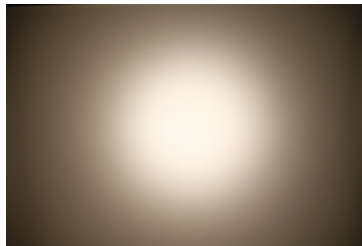

LUMILEDS

LED LUXEON CoB 1213/1216/1812
 FWHM / FWTM 25.0° / 68.0°
 Efficiency 85 %
 Peak intensity 2.4 cd/m
 LEDs/each optic 1
 Light colour White
 Required components:
 A.A.G. STUCCHI: 8102-G2 + S-8000-12

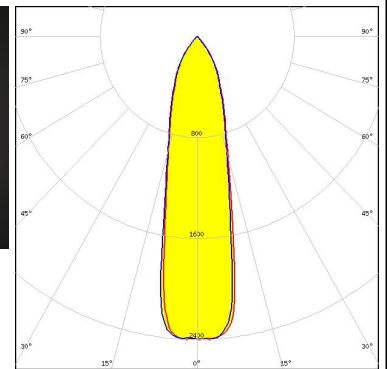
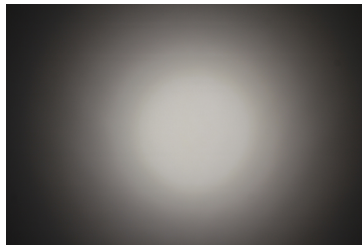



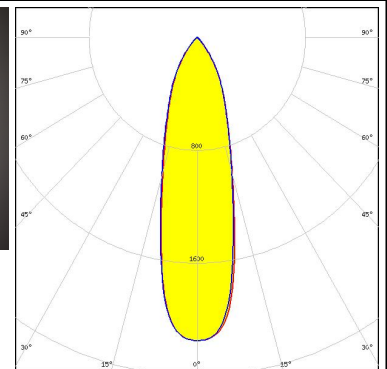
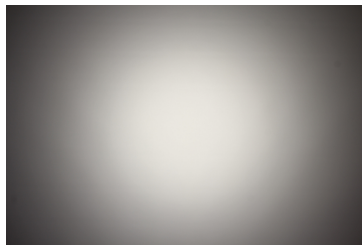

LUMILEDS

LED LUXEON CoB 1213/1216/1812
 FWHM / FWTM 28.0° / 69.0°
 Efficiency 87 %
 Peak intensity 2.2 cd/m
 LEDs/each optic 1
 Light colour White
 Required components:
 C12692_LENINA-STD-BASE-CLL040
 C12606_LENINA-DL

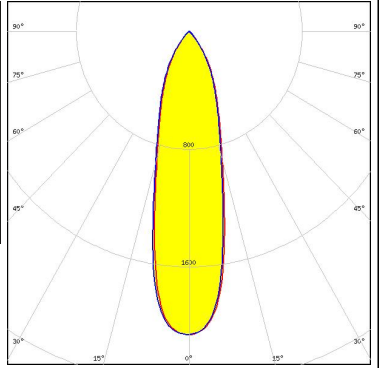
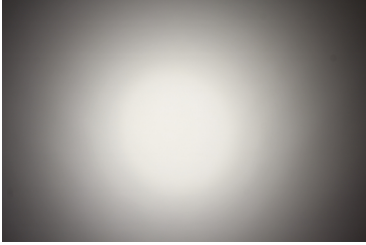
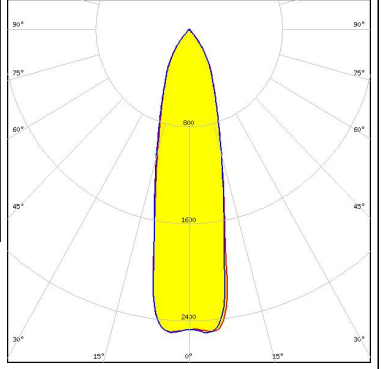

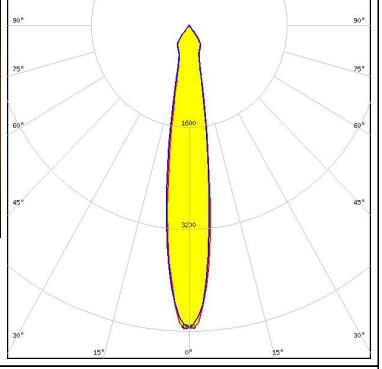
OPTICAL RESULTS (MEASURED):

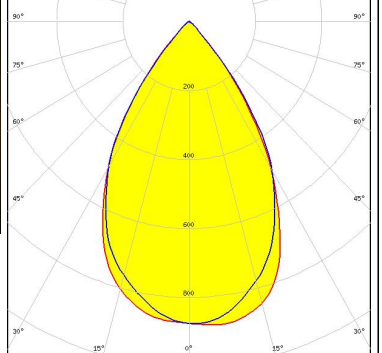
<p>LUMILEDS</p> <p>LED LUXEON CoB 1213/1216/1812</p> <p>FWHM / FWTM 27.0° / 69.0°</p> <p>Efficiency 81 %</p> <p>Peak intensity 2.1 cd/m</p> <p>LEDs/each optic 1</p> <p>Light colour White</p> <p>Required components: C12606_LENINA-DL A.A.G. STUCCHI: 8102-G2 + S-8000-12</p>		
<p>LUMILEDS</p> <p>LED LUXEON CoB 1213/1216/1812</p> <p>FWHM / FWTM 27.0° / 68.0°</p> <p>Efficiency 91 %</p> <p>Peak intensity 2.5 cd/m</p> <p>LEDs/each optic 1</p> <p>Light colour White</p> <p>Required components: C12692_LENINA-STD-BASE-CLL040</p>		
<p>LUMILEDS</p> <p>LED LUXEON K12</p> <p>FWHM / FWTM 16.0° / 41.0°</p> <p>Efficiency 89 %</p> <p>Peak intensity 4.8 cd/m</p> <p>LEDs/each optic 1</p> <p>Light colour White</p> <p>Required components: C12924_LENINA-STD-BASE-LUXEON-K</p>		
<p>LUMILEDS</p> <p>LED LUXEON K12</p> <p>FWHM / FWTM 17.5° / 57.0°</p> <p>Efficiency 83 %</p> <p>Peak intensity 3.7 cd/m</p> <p>LEDs/each optic 1</p> <p>Light colour White</p> <p>Required components: C12924_LENINA-STD-BASE-LUXEON-K C12606_LENINA-DL</p>		

OPTICAL RESULTS (MEASURED):

LUMILEDS

LED LUXEON K16
FWHM / FWTM 22.0° / 64.0°
Efficiency 80 %
Peak intensity 2.6 cd/lm
LEDs/each optic 1
Light colour White

Required components:

C12924_LENASTD-BASE-LUXEON-K
C12606_LENINA-DL

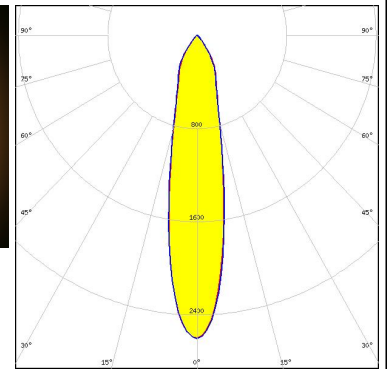
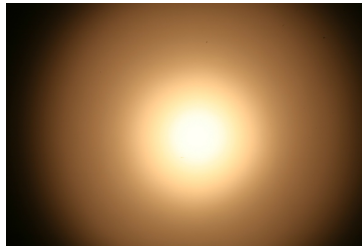

LUMILEDS

LED LUXEON K16
FWHM / FWTM 18.0° / 50.0°
Efficiency 87 %
Peak intensity 4 cd/lm
LEDs/each optic 1
Light colour White

Required components:

C12924_LENASTD-BASE-LUXEON-K

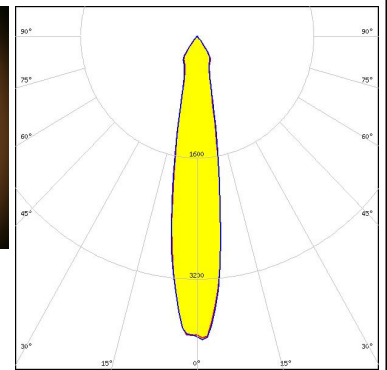
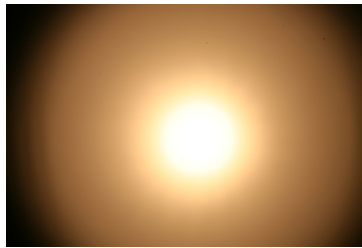

LUMINUS

LED CDM-14 (Dim-To-Warm)
FWHM / FWTM 16.0° / 38.0°
Efficiency 88 %
Peak intensity 4.9 cd/lm
LEDs/each optic 1
Light colour White

Required components:

C13868_LENASTD-BASE-VERO13-18
C12606_LENINA-DL
Bender Wirth: 491 Typ L2

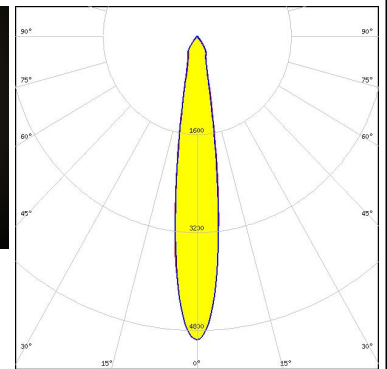

LUMINUS

LED CDM-18 (Dim-To-Warm)
FWHM / FWTM 21.0° / 51.0°
Efficiency 88 %
Peak intensity 3.6 cd/lm
LEDs/each optic 1
Light colour White

Required components:

C13868_LENASTD-BASE-VERO13-18
C12606_LENINA-DL
Bender Wirth: 491 Typ L2

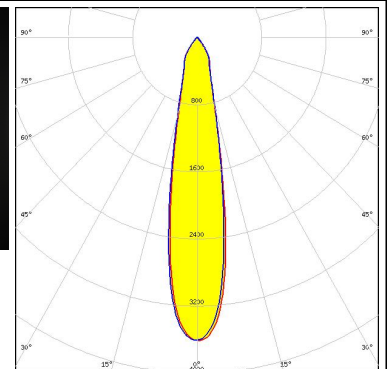
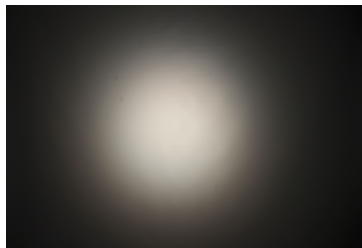

OPTICAL RESULTS (MEASURED):



LED CDM-9 (Dim-To-Warm)
FWHM / FWTM 13.0° / 27.0°
Efficiency 87 %
Peak intensity 7.4 cd/lm
LEDs/each optic 1
Light colour White
Required components:
 C13868_LENINA-STD-BASE-VERO13-18
 C12606_LENINA-DL
 Bender Wirth: 490 Typ L1

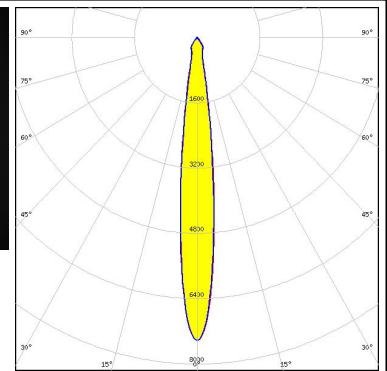

LED CDM-9 (Dim-To-Warm)
FWHM / FWTM 11.0° / 21.0°
Efficiency 92 %
Peak intensity 12 cd/lm
LEDs/each optic 1
Light colour White
Required components:
 C13868_LENINA-STD-BASE-VERO13-18
 Bender Wirth: 490 Typ L1

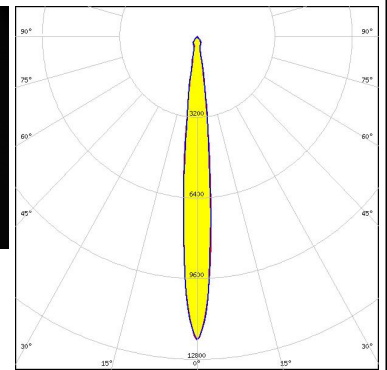



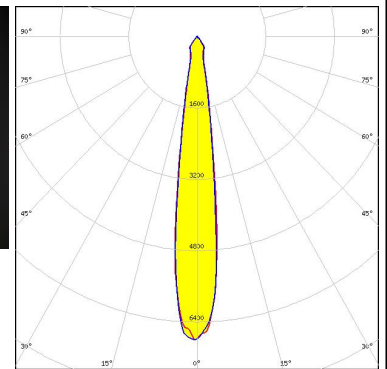

LED CTM-14 (Tunable White)
FWHM / FWTM 15.0° / 29.0°
Efficiency 92 %
Peak intensity 6.8 cd/lm
LEDs/each optic 1
Light colour White
Required components:
 C13867_LENINA-STD-BASE-VERO29
 Bender Wirth: 442 Typ L3

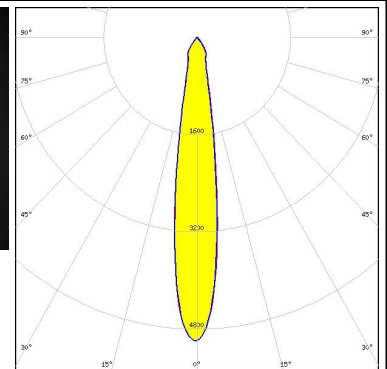

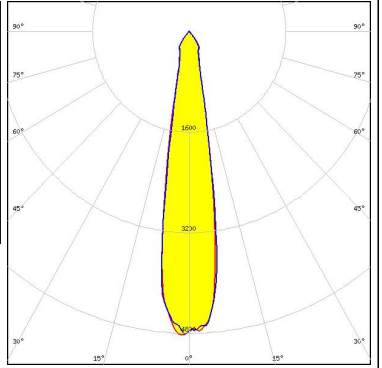

LED CTM-14 (Tunable White)
FWHM / FWTM 16.0° / 37.0°
Efficiency 87 %
Peak intensity 5 cd/lm
LEDs/each optic 1
Light colour White
Required components:
 C13867_LENINA-STD-BASE-VERO29
 C12606_LENINA-DL
 Bender Wirth: 442 Typ L3

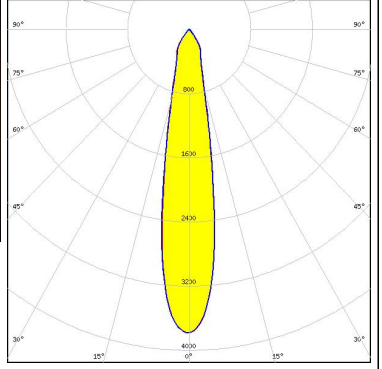
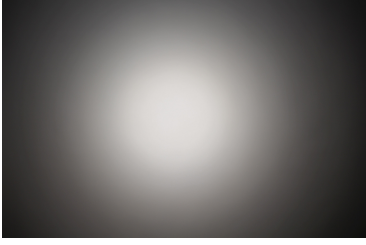
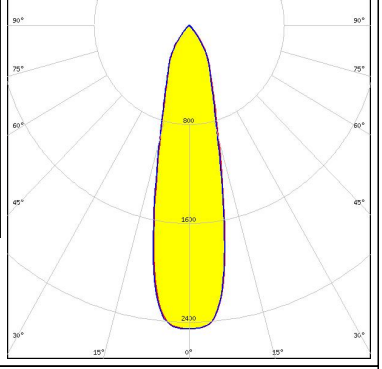

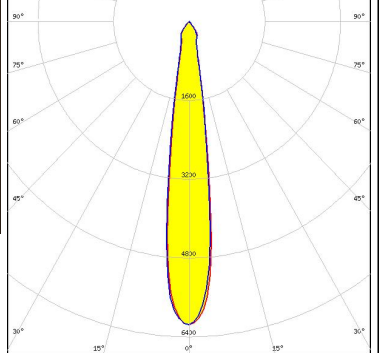

OPTICAL RESULTS (MEASURED):

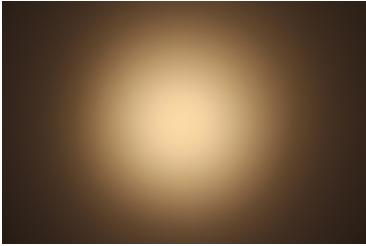
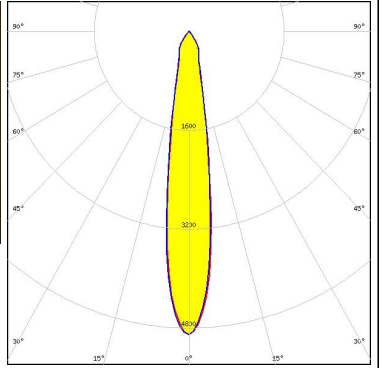
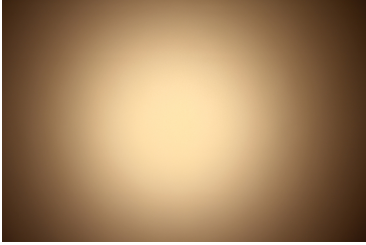
<p>LUMINUS</p> <p>LED CTM-18 (Tunable White) FWHM / FWTM 18.0° / 39.0° Efficiency 92 % Peak intensity 4.8 cd/m² LEDs/each optic 1 Light colour White</p> <p>Required components: C13867_LENINA-STD-BASE-VERO29 Bender Wirth: 442 Typ L3</p>		
<p>LUMINUS</p> <p>LED CTM-18 (Tunable White) FWHM / FWTM 19.0° / 48.0° Efficiency 87 % Peak intensity 3.8 cd/m² LEDs/each optic 1 Light colour White</p> <p>Required components: C13867_LENINA-STD-BASE-VERO29 C12606_LENINA-DL Bender Wirth: 442 Typ L3</p>		
<p>LUMINUS</p> <p>LED CTM-22 (Tunable White) FWHM / FWTM 26.0° / 67.0° Efficiency 87 % Peak intensity 2.4 cd/m² LEDs/each optic 1 Light colour White</p> <p>Required components: C13867_LENINA-STD-BASE-VERO29 C12606_LENINA-DL Bender Wirth: 494 Typ L3</p>		
<p>LUMINUS</p> <p>LED CxM-14 (19x19) FWHM / FWTM 16.0° / 32.0° Efficiency 93 % Peak intensity 6.2 cd/m² LEDs/each optic 1 Light colour White</p> <p>Required components: C12691_LENINA-STD-BASE-CLL030</p>		

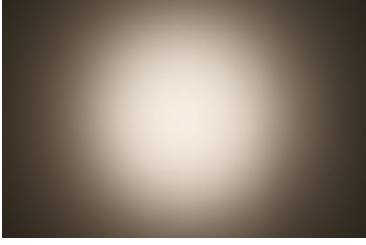
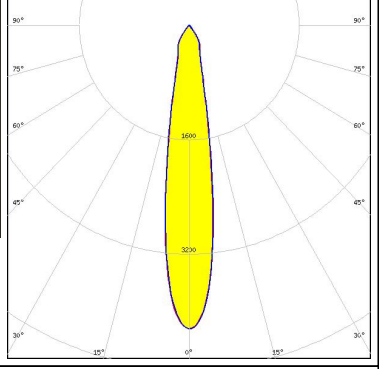
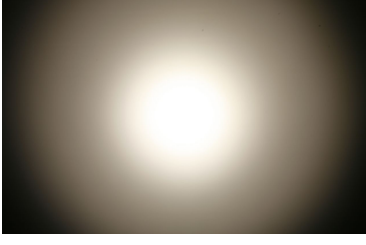
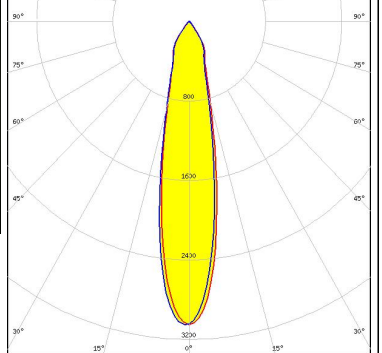

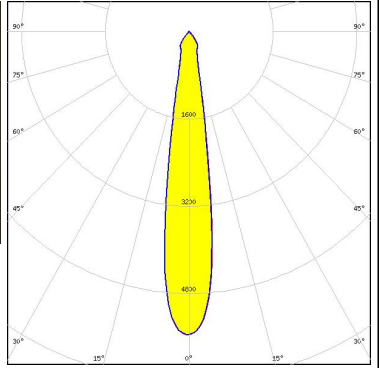
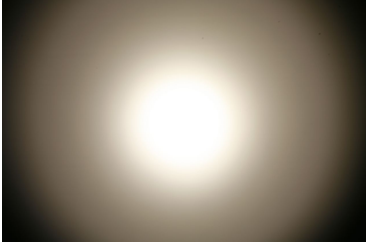
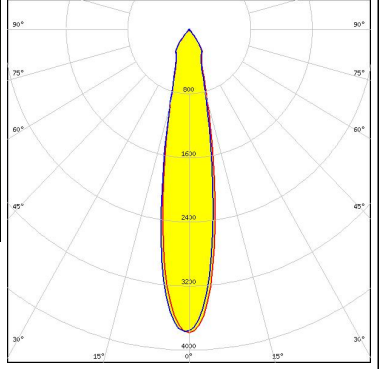
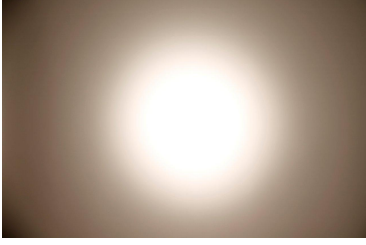
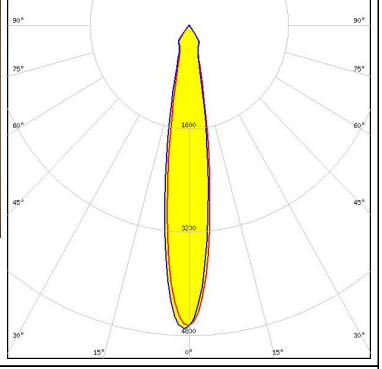

OPTICAL RESULTS (MEASURED):

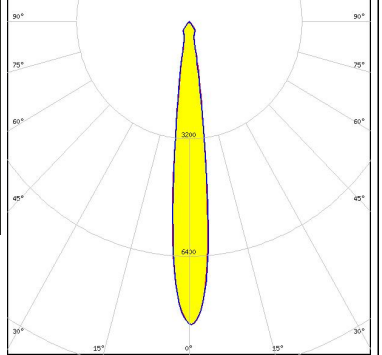
<p>LUMINUS</p> <p>LED CxM-14 (19x19) FWHM / FWTM 17.0° / 40.0° Efficiency 88 % Peak intensity 4.9 cd/lm LEDs/each optic 1 Light colour White</p> <p>Required components: C12691_LENINA-STD-BASE-CLL030 C12606_LENINA-DL</p>		
<p>LUMINUS</p> <p>LED CxM-22 (28x28) FWHM / FWTM 28.0° / 72.0° Efficiency 88 % Peak intensity 2.3 cd/lm LEDs/each optic 1 Light colour White</p> <p>Required components: C12692_LENINA-STD-BASE-CLL040 C12606_LENINA-DL</p>		
<p>NICHIA</p> <p>LED COB J-Type FWHM / FWTM 18.0° / 44.0° Efficiency 88 % Peak intensity 4.2 cd/lm LEDs/each optic 1 Light colour White</p> <p>Required components: C13868_LENINA-STD-BASE-VERO13-18 C12606_LENINA-DL Bender Wirth: 463 Typ L2</p>		
<p>NICHIA</p> <p>LED COB J-Type FWHM / FWTM 21.0° / 61.0° Efficiency 83 % Peak intensity 3.1 cd/lm LEDs/each optic 1 Light colour White</p> <p>Required components: C12292_LENINA-STD-BASE-MEZ C12606_LENINA-DL</p>		



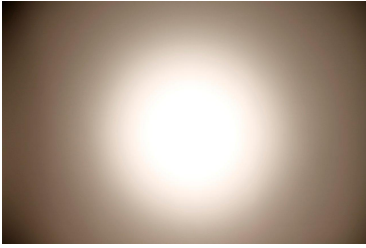
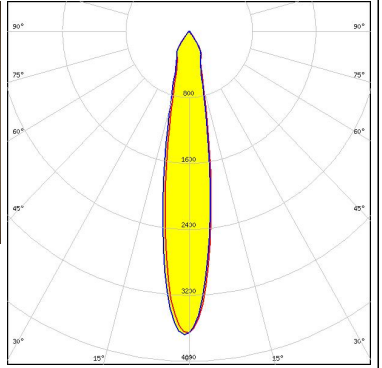

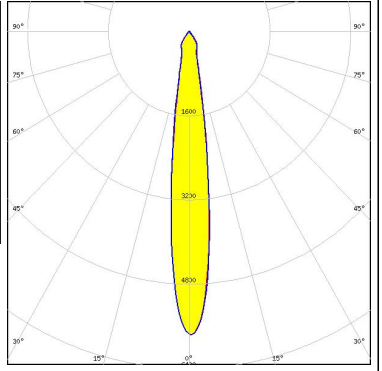
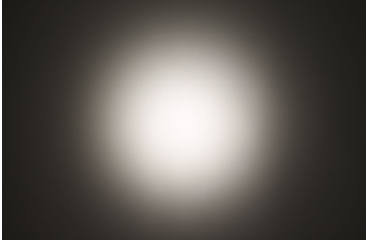
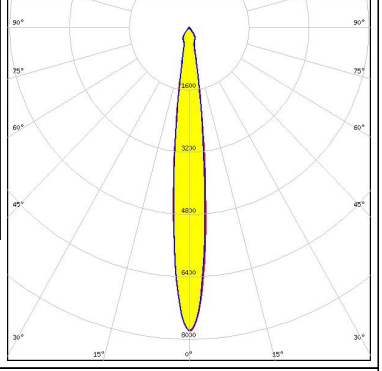

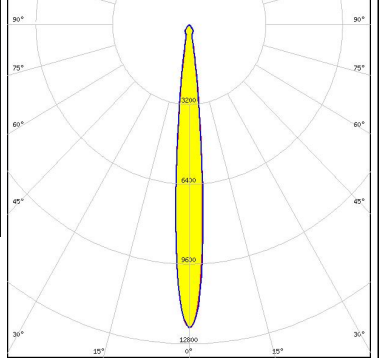
OPTICAL RESULTS (MEASURED):

<p>NICHIA</p> <p>LED COB J-Type FWHM / FWTM 17.0° / 35.0° Efficiency 92 % Peak intensity 5.6 cd/m LEDs/each optic 1 Light colour White</p> <p>Required components: C13868_LENASTD-BASE-VERO13-18 Bender Wirth: 463 Typ L2</p>		
<p>NICHIA</p> <p>LED COB J-Type FWHM / FWTM 20.0° / 51.0° Efficiency 88 % Peak intensity 3.8 cd/m LEDs/each optic 1 Light colour White</p> <p>Required components: C12292_LENASTD-BASE-MEZ</p>		
<p>NICHIA</p> <p>LED COB L-Type (LES 11) FWHM / FWTM 17.0° / 38.0° Efficiency 85 % Peak intensity 4.7 cd/m LEDs/each optic 1 Light colour White</p> <p>Required components: C11981_LENASTD-BASE-COB-L110</p>		
<p>NICHIA</p> <p>LED COB L-Type (LES 11) FWHM / FWTM 13.0° / 26.0° Efficiency 91 % Peak intensity 8.3 cd/m LEDs/each optic 1 Light colour White</p> <p>Required components: C13868_LENASTD-BASE-VERO13-18 Bender Wirth: 438 Typ L1</p>		

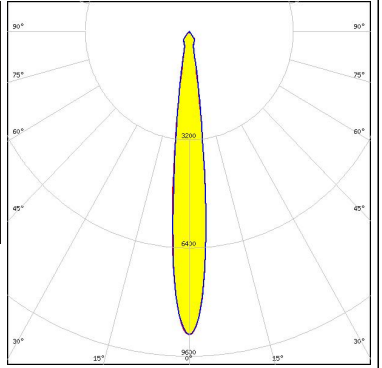
OPTICAL RESULTS (MEASURED):

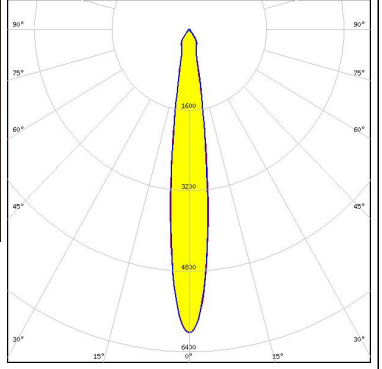
<p>NICHIA</p> <p>LED COB L-Type (LES 11) FWHM / FWTM 18.0° / 49.0° Efficiency 81 % Peak intensity 3.7 cd/lm LEDs/each optic 1 Light colour White</p> <p>Required components: C11981_LENINA-STD-BASE-COB-L110 C12606_LENINA-DL</p>		
<p>NICHIA</p> <p>LED COB L-Type (LES 11) FWHM / FWTM 15.0° / 32.0° Efficiency 87 % Peak intensity 5.8 cd/lm LEDs/each optic 1 Light colour White</p> <p>Required components: C13868_LENINA-STD-BASE-VERO13-18 C12606_LENINA-DL Bender Wirth: 438 Typ L1</p>		
<p>NICHIA</p> <p>LED COB L-Type (LES 9) FWHM / FWTM 12.0° / 26.0° Efficiency 90 % Peak intensity 7.8 cd/lm LEDs/each optic 1 Light colour White</p> <p>Required components: C13868_LENINA-STD-BASE-VERO13-18 C12606_LENINA-DL Bender Wirth: 438 Typ L1</p>		
<p>NICHIA</p> <p>LED COB L-Type (LES 9) FWHM / FWTM 10.0° / 21.0° Efficiency 94 % Peak intensity 12.1 cd/lm LEDs/each optic 1 Light colour White</p> <p>Required components: C13868_LENINA-STD-BASE-VERO13-18 Bender Wirth: 438 Typ L1</p>		

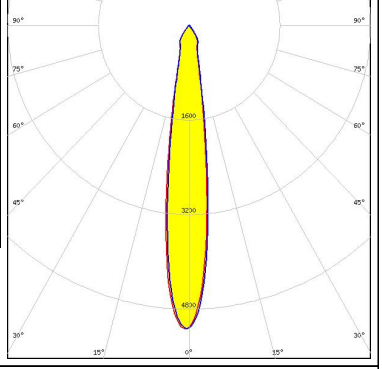
OPTICAL RESULTS (MEASURED):

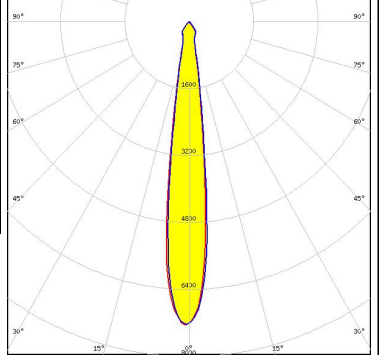
<p>NICHIA</p> <p>LED NVCWJ024Z-V1MT: COB J-Type Tunable White</p> <p>FWHM / FWTM 12.0° / 25.0°</p> <p>Efficiency 92 %</p> <p>Peak intensity 9 cd/lm</p> <p>LEDs/each optic 1</p> <p>Light colour White</p> <p>Required components: C13868_LENINA-STD-BASE-VERO13-18 Bender Wirth: 498 Typ L2</p>		
<p>NICHIA</p> <p>LED NVCWJ024Z-V1MT: COB J-Type Tunable White</p> <p>FWHM / FWTM 14.0° / 32.0°</p> <p>Efficiency 88 %</p> <p>Peak intensity 6 cd/lm</p> <p>LEDs/each optic 1</p> <p>Light colour White</p> <p>Required components: C13868_LENINA-STD-BASE-VERO13-18 C12606_LENINA-DL Bender Wirth: 498 Typ L2</p>		
<p>OSRAM Opto Semiconductors</p> <p>LED Soleriq S13</p> <p>FWHM / FWTM 16.0° / 36.0°</p> <p>Efficiency 86 %</p> <p>Peak intensity 5.1 cd/lm</p> <p>LEDs/each optic 1</p> <p>Light colour White</p> <p>Required components: C13868_LENINA-STD-BASE-VERO13-18 C12606_LENINA-DL Bender Wirth: 437 Typ L1</p>		
<p>OSRAM Opto Semiconductors</p> <p>LED Soleriq S13</p> <p>FWHM / FWTM 14.0° / 28.0°</p> <p>Efficiency 91 %</p> <p>Peak intensity 7.2 cd/lm</p> <p>LEDs/each optic 1</p> <p>Light colour White</p> <p>Required components: C13868_LENINA-STD-BASE-VERO13-18 Bender Wirth: 437 Typ L1</p>		

OPTICAL RESULTS (MEASURED):

OSRAM

Opto Semiconductors

LED Soleriq S19
FWHM / FWTM 19.0° / 47.0°
Efficiency 92 %
Peak intensity 4.1 cd/lm
LEDs/each optic 1
Light colour White

Required components:

C13867_LENINA-STD-BASE-VERO29
Bender Wirth: 462 Typ L3

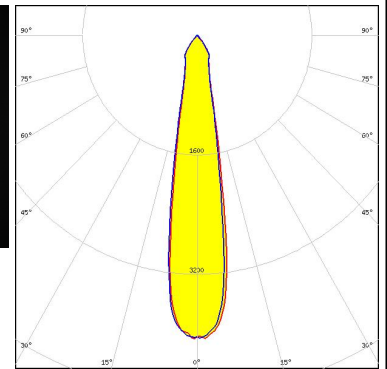

OSRAM

Opto Semiconductors

LED Soleriq S19
FWHM / FWTM 20.0° / 53.0°
Efficiency 88 %
Peak intensity 3.7 cd/lm
LEDs/each optic 1
Light colour White

Required components:

C13867_LENINA-STD-BASE-VERO29
C12606_LENINA-DL
Bender Wirth: 462 Typ L3

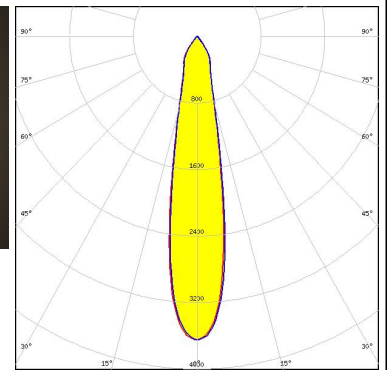
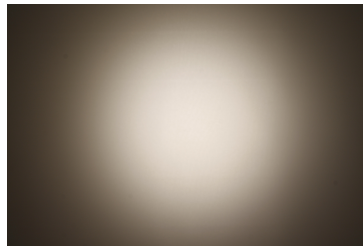

PHILIPS

LED Fortimo SLM L13 CoB
FWHM / FWTM 18.0° / 49.0°
Efficiency 87 %
Peak intensity 4 cd/lm
LEDs/each optic 1
Light colour White

Required components:

C12292_LENINA-STD-BASE-MEZ
C12606_LENINA-DL

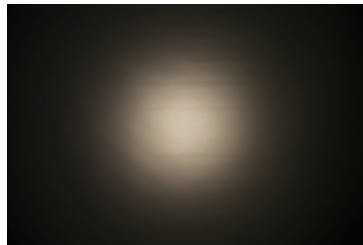

PHILIPS

LED Fortimo SLM L13 CoB
FWHM / FWTM 15.0° / 34.0°
Efficiency 93 %
Peak intensity 6 cd/lm
LEDs/each optic 1
Light colour White

Required components:

C12292_LENINA-STD-BASE-MEZ

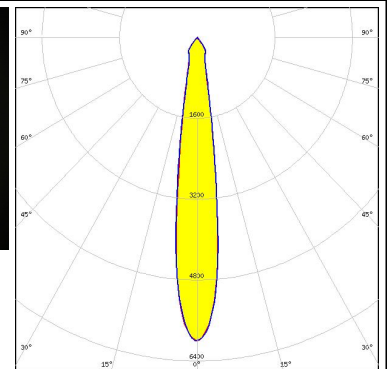
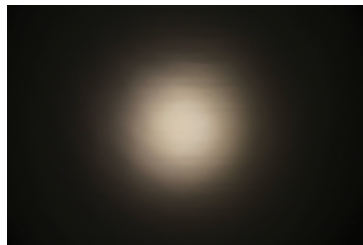

OPTICAL RESULTS (MEASURED):

PHILIPS

LED Fortimo SLM L15 CoB
 FWHM / FWTM 18.0° / 42.0°
 Efficiency 91 %
 Peak intensity 4.7 cd/m
 LEDs/each optic 1
 Light colour White
 Required components:
 C12292_LENINA-STD-BASE-MEZ

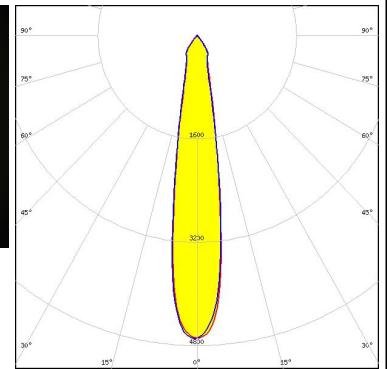
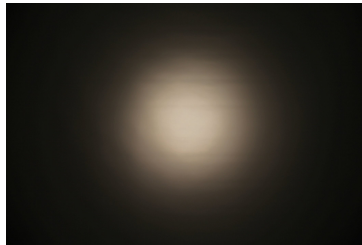

PHILIPS

LED Fortimo SLM L15 CoB
 FWHM / FWTM 20.0° / 58.0°
 Efficiency 86 %
 Peak intensity 3.3 cd/m
 LEDs/each optic 1
 Light colour White
 Required components:
 C12292_LENINA-STD-BASE-MEZ
 C12606_LENINA-DL

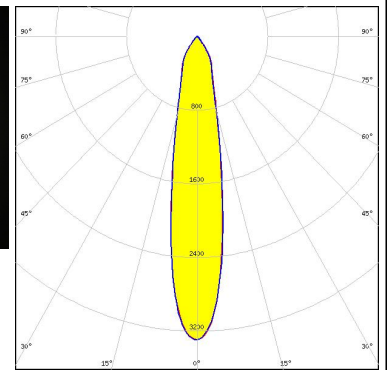
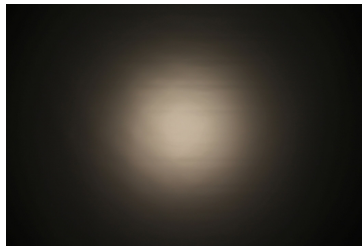

PHILIPS

LED Fortimo SLM L19 CoB
 FWHM / FWTM 24.0° / 66.0°
 Efficiency 86 %
 Peak intensity 2.5 cd/m
 LEDs/each optic 1
 Light colour White
 Required components:
 C12692_LENINA-STD-BASE-CLL040
 C12606_LENINA-DL

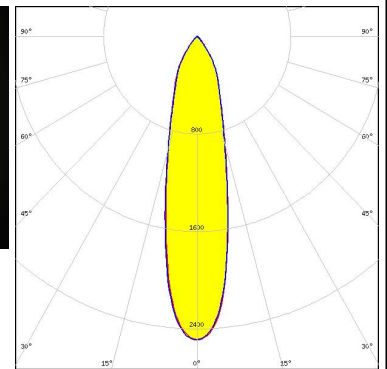
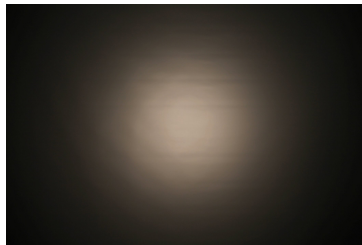

PHILIPS

LED Fortimo SLM L19 CoB
 FWHM / FWTM 22.0° / 64.0°
 Efficiency 91 %
 Peak intensity 3.2 cd/m
 LEDs/each optic 1
 Light colour White
 Required components:
 C12692_LENINA-STD-BASE-CLL040

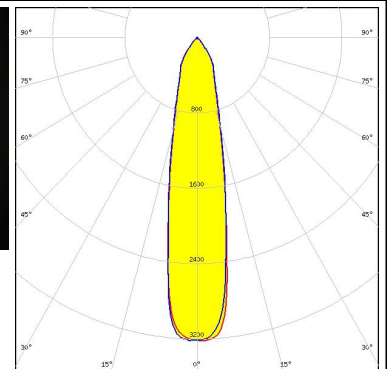
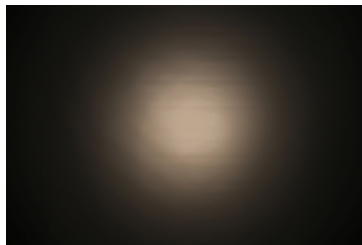

OPTICAL RESULTS (MEASURED):

PHILIPS

LED Fortimo SLM L23 CoB
 FWHM / FWTM 27.0° / 69.0°
 Efficiency 91 %
 Peak intensity 2.4 cd/lm
 LEDs/each optic 1
 Light colour White
 Required components:
 C12692_LENINA-STD-BASE-CLL040

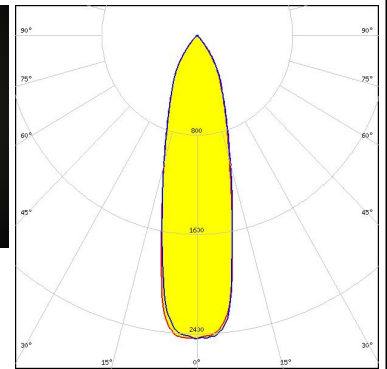
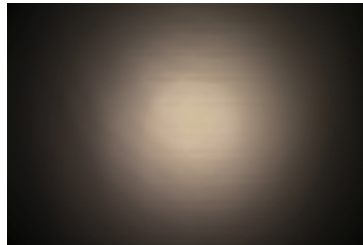

PHILIPS

LED Fortimo SLM L23 CoB
 FWHM / FWTM 29.0° / 70.0°
 Efficiency 86 %
 Peak intensity 2 cd/lm
 LEDs/each optic 1
 Light colour White
 Required components:
 C12692_LENINA-STD-BASE-CLL040
 C12606_LENINA-DL

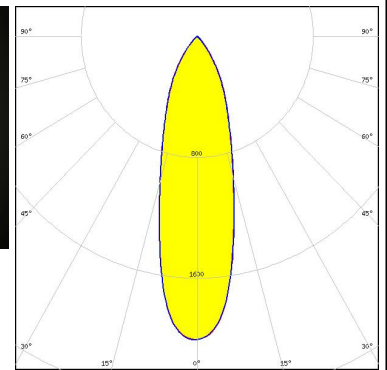
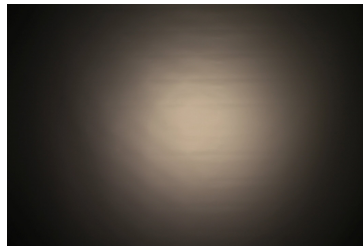

SAMSUNG

LED LC016D / LC019D / LC026D / LC033D
 FWHM / FWTM 16.0° / 37.0°
 Efficiency 91 %
 Peak intensity 5.3 cd/lm
 LEDs/each optic 1
 Light colour White
 Required components:
 C12691_LENINA-STD-BASE-CLL030

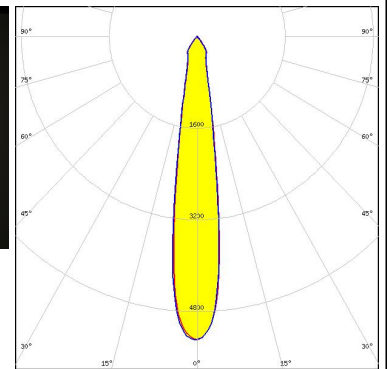

SAMSUNG

LED LC016D / LC019D / LC026D / LC033D
 FWHM / FWTM 18.0° / 47.0°
 Efficiency 87 %
 Peak intensity 4.1 cd/lm
 LEDs/each optic 1
 Light colour White
 Required components:
 C12691_LENINA-STD-BASE-CLL030
 C12606_LENINA-DL

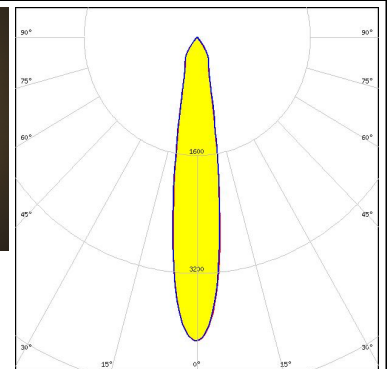
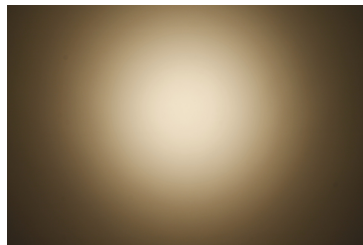

OPTICAL RESULTS (MEASURED):

SAMSUNG

LED LC026B / 033B / 040B
 FWHM / FWTM 20.0° / 48.0°
 Efficiency 91 %
 Peak intensity 4 cd/m
 LEDs/each optic 1
 Light colour White
 Required components:
 C13868_LENINA-STD-BASE-VERO13-18
 Bender Wirth: 450 Typ L2

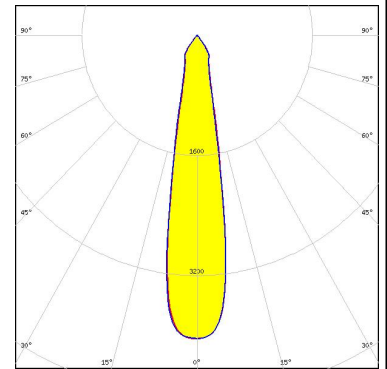

SAMSUNG

LED LC026B / 033B / 040B
 FWHM / FWTM 21.0° / 58.0°
 Efficiency 87 %
 Peak intensity 3.3 cd/m
 LEDs/each optic 1
 Light colour White
 Required components:
 C13868_LENINA-STD-BASE-VERO13-18
 C12606_LENINA-DL
 Bender Wirth: 450 Typ L2

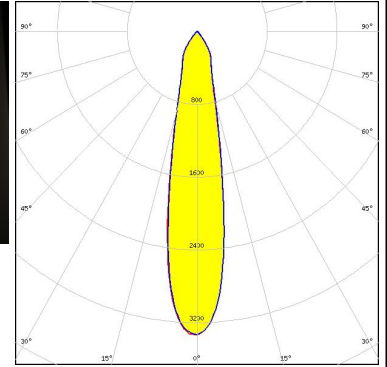

SAMSUNG

LED LC040D / LC060D / LC080D
 FWHM / FWTM 28.0° / 69.0°
 Efficiency 91 %
 Peak intensity 2.4 cd/m
 LEDs/each optic 1
 Light colour White
 Required components:
 C12692_LENINA-STD-BASE-CLL040

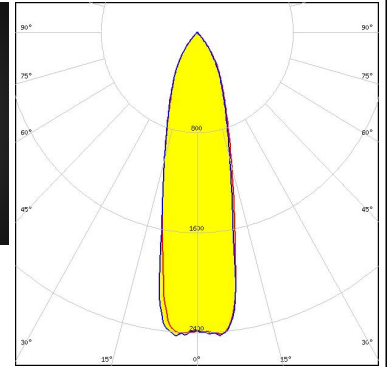
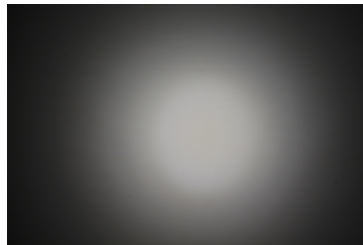



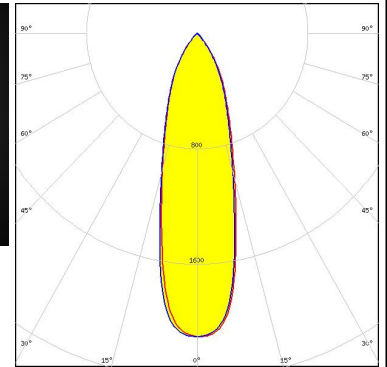
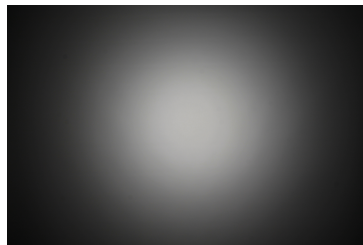

SAMSUNG

LED LC040D / LC060D / LC080D
 FWHM / FWTM 29.0° / 70.0°
 Efficiency 87 %
 Peak intensity 2.1 cd/m
 LEDs/each optic 1
 Light colour White
 Required components:
 C12692_LENINA-STD-BASE-CLL040
 C12606_LENINA-DL

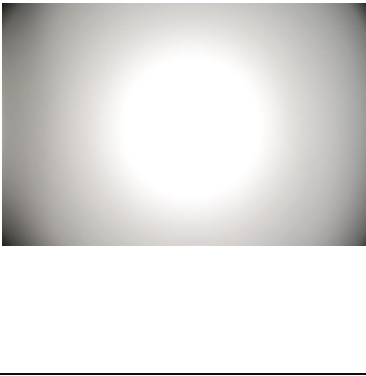
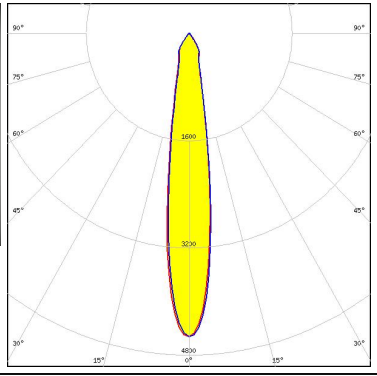
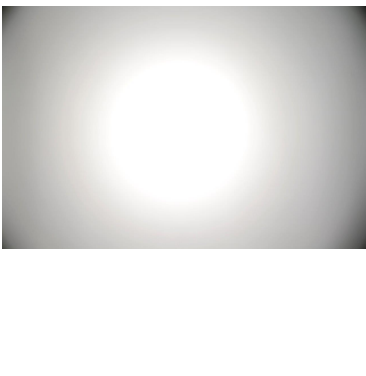
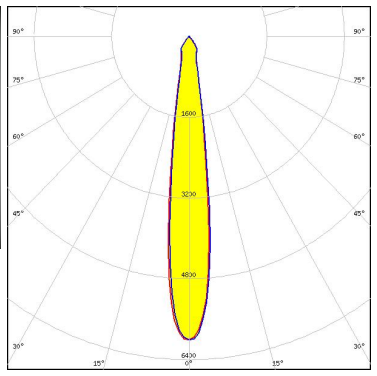

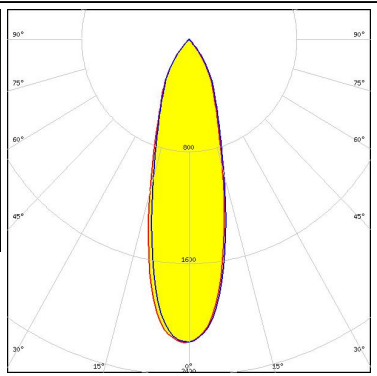
OPTICAL RESULTS (MEASURED):

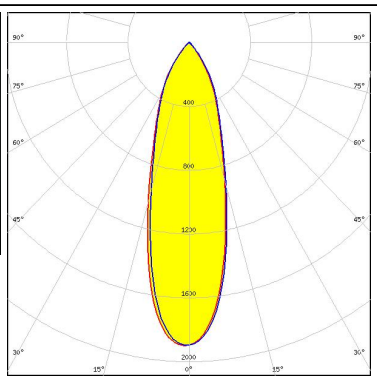
<p>SEOUL SEMICONDUCTOR</p> <p>LED ZC12/18 FWHM / FWTM 16.0° / 41.0° Efficiency 85 % Peak intensity 4.5 cd/lm LEDs/each optic 1 Light colour White</p> <p>Required components: C12691_LENINA-STD-BASE-CLL030 C12606_LENINA-DL</p>		
<p>SEOUL SEMICONDUCTOR</p> <p>LED ZC12/18 FWHM / FWTM 15.0° / 32.0° Efficiency 90 % Peak intensity 6 cd/lm LEDs/each optic 1 Light colour White</p> <p>Required components: C12691_LENINA-STD-BASE-CLL030</p>		
<p>SEOUL SEMICONDUCTOR</p> <p>LED ZC25/40/60 FWHM / FWTM 29.0° / 70.0° Efficiency 86 % Peak intensity 2.2 cd/lm LEDs/each optic 1 Light colour White</p> <p>Required components: C12692_LENINA-STD-BASE-CLL040</p>		
<p>SEOUL SEMICONDUCTOR</p> <p>LED ZC25/40/60 FWHM / FWTM 30.0° / 71.0° Efficiency 82 % Peak intensity 1.9 cd/lm LEDs/each optic 1 Light colour White</p> <p>Required components: C12692_LENINA-STD-BASE-CLL040 C12606_LENINA-DL</p>		

OPTICAL RESULTS (MEASURED):

SHARP

LED Mega Zenigata (GW5DGC)
 FWHM / FWTM 24.0° / 62.0°
 Efficiency 80 %
 Peak intensity 2.8 cd/lm
 LEDs/each optic 1
 Light colour White
 Required components:
 C12292_LENINA-STD-BASE-MEZ
 C12606_LENINA-DL

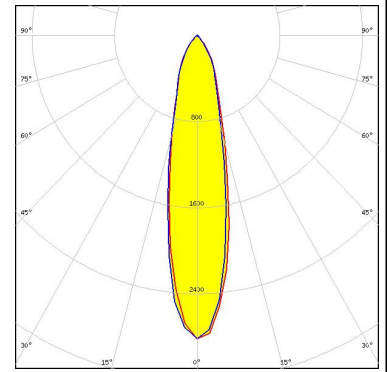

SHARP

LED Mega Zenigata (GW5DGC)
 FWHM / FWTM 17.0° / 46.0°
 Efficiency 88 %
 LEDs/each optic 1
 Light colour White
 Required components:
 C12292_LENINA-STD-BASE-MEZ

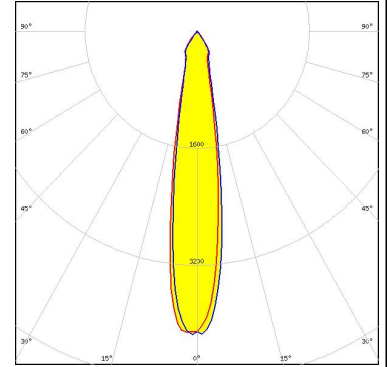

SHARP

LED Mega Zenigata (GW6DME)
 FWHM / FWTM 21.0° / 60.0°
 Efficiency 83 %
 Peak intensity 3.2 cd/lm
 LEDs/each optic 1
 Light colour White
 Required components:
 C12292_LENINA-STD-BASE-MEZ
 C12606_LENINA-DL

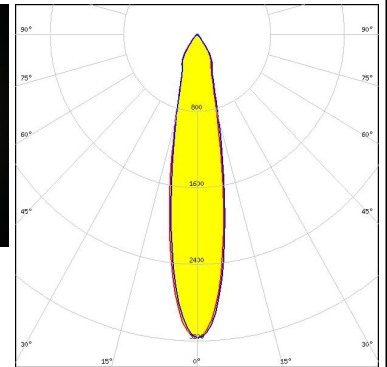

SHARP

LED Mega Zenigata (GW6DME)
 FWHM / FWTM 19.0° / 47.0°
 Efficiency 88 %
 Peak intensity 3.9 cd/lm
 LEDs/each optic 1
 Light colour White
 Required components:
 C12292_LENINA-STD-BASE-MEZ

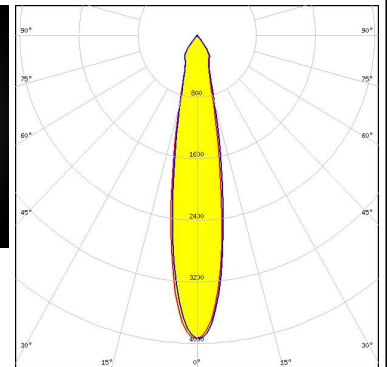

OPTICAL RESULTS (MEASURED):

TRIDONIC

LED SLE G7 LES15
 FWHM / FWTM 16.0° / 36.0°
 Efficiency 93 %
 Peak intensity 5.6 cd/m
 LEDs/each optic 1
 Light colour White
 Required components:
 C12691_LENINA-STD-BASE-CLL030

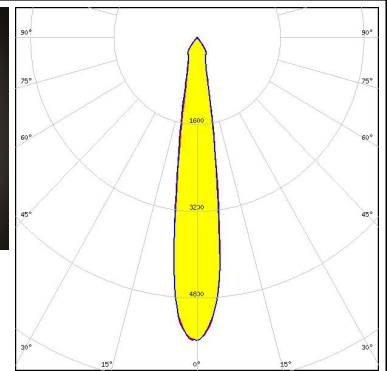
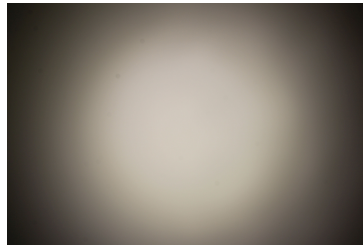

TRIDONIC

LED SLE G7 LES17 H
 FWHM / FWTM 19.0° / 46.0°
 Efficiency 91 %
 Peak intensity 4.3 cd/m
 LEDs/each optic 1
 Light colour White
 Required components:
 C14547_LENINA-ADAPTER-B

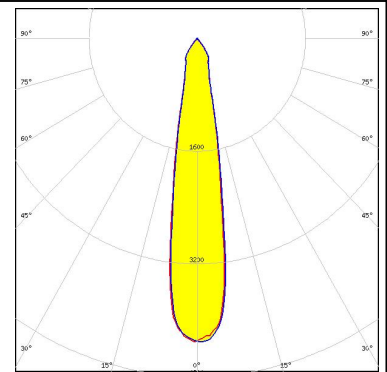

TRIDONIC

LED SLE G7 LES21 H
 FWHM / FWTM 24.0° / 65.0°
 Efficiency 91 %
 Peak intensity 2.9 cd/m
 LEDs/each optic 1
 Light colour White
 Required components:
 C14547_LENINA-ADAPTER-B

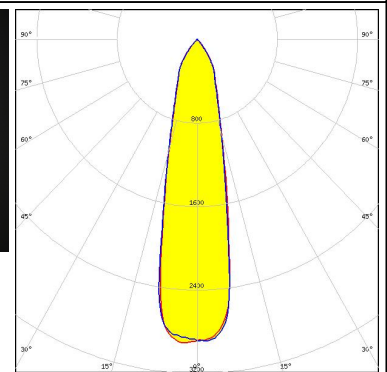
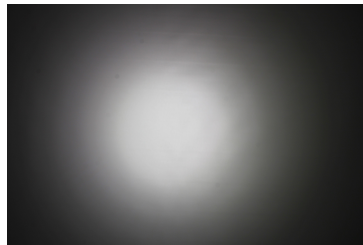





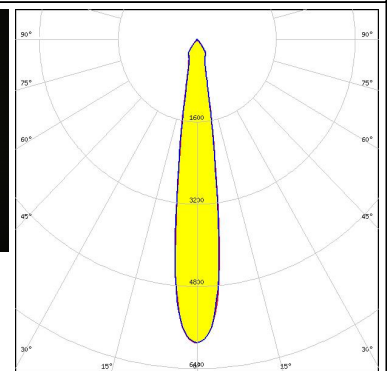

XICATO

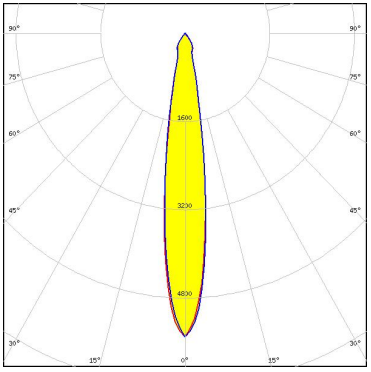

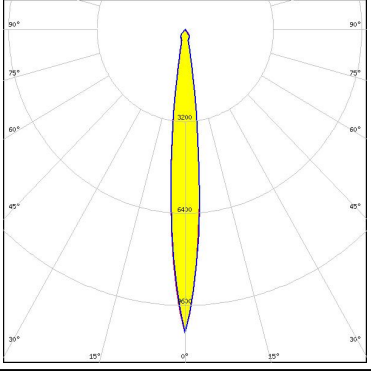

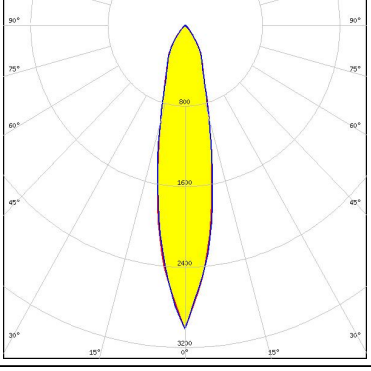

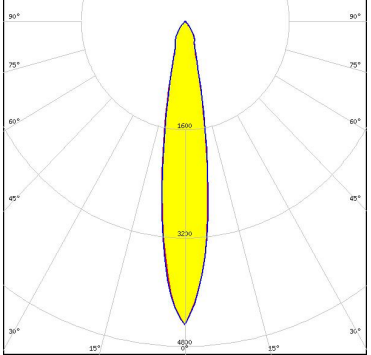
LED XOB 14.5 mm
 FWHM / FWTM 16.0° / 34.0°
 Efficiency 93 %
 Peak intensity 5.9 cd/m
 LEDs/each optic 1
 Light colour White
 Required components:
 C12691_LENINA-STD-BASE-CLL030

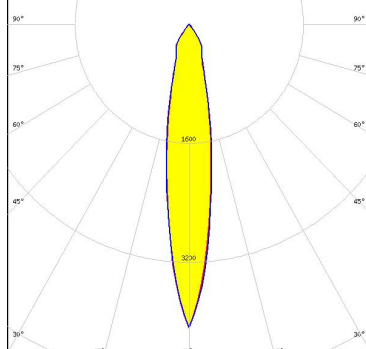

OPTICAL RESULTS (SIMULATED):

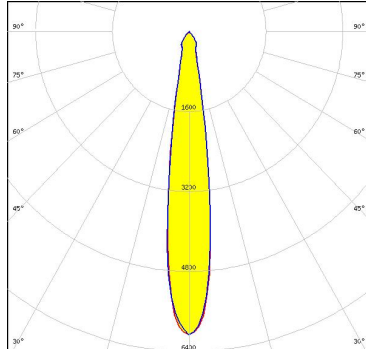
<p></p> <p>LED V10 Gen7 FWHM / FWTM 16.0° / 33.0° Efficiency 85 % Peak intensity 5.5 cd/lm LEDs/each optic 1 Light colour White</p> <p>Required components: C13868_LENINA-STD-BASE-VERO13-18 C12606_LENINA-DL Bender Wirth: 486 Typ L1</p>	
<p></p> <p>LED V10 Gen7 FWHM / FWTM 11.0° / 24.0° Efficiency 91 % Peak intensity 10.6 cd/lm LEDs/each optic 1 Light colour White</p> <p>Required components: C13868_LENINA-STD-BASE-VERO13-18 Bender Wirth: 486 Typ L1</p>	
<p></p> <p>LED V13 Gen7 FWHM / FWTM 22.0° / 62.0° Efficiency 87 % Peak intensity 3 cd/lm LEDs/each optic 1 Light colour White</p> <p>Required components: C12606_LENINA-DL IDEAL: 50-2103CT + 50-2100AN</p>	
<p></p> <p>LED V13 Gen7 FWHM / FWTM 18.0° / 41.0° Efficiency 86 % Peak intensity 4.5 cd/lm LEDs/each optic 1 Light colour White</p> <p>Required components: C13868_LENINA-STD-BASE-VERO13-18 C12606_LENINA-DL Bender Wirth: 477 Typ L1</p>	

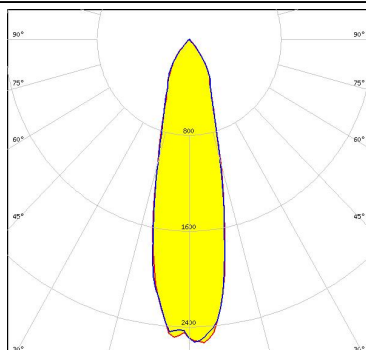
OPTICAL RESULTS (SIMULATED):

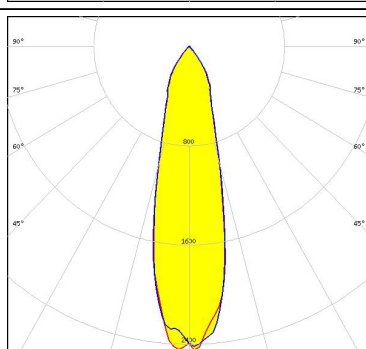
<p></p> <p>LED V13 Gen7 FWHM / FWTM 18.0° / 52.0° Efficiency 90 % Peak intensity 4.1 cd/lm LEDs/each optic 1 Light colour White Required components: IDEAL: 50-2103CT + 50-2100AN</p>	
<p></p> <p>LED V13 Gen7 FWHM / FWTM 16.0° / 32.0° Efficiency 91 % Peak intensity 6.1 cd/lm LEDs/each optic 1 Light colour White Required components: C13868_LENINA-STD-BASE-VERO13-18 Bender Wirth: 477 Typ L1</p>	
<p></p> <p>LED V22 Gen7 FWHM / FWTM 27.0° / 70.0° Efficiency 90 % Peak intensity 2.7 cd/lm LEDs/each optic 1 Light colour White Required components: C13867_LENINA-STD-BASE-VERO29 Bender Wirth: 431 Typ L3</p>	
<p></p> <p>LED V22 Gen7 FWHM / FWTM 26.0° / 68.0° Efficiency 87 % Peak intensity 2.5 cd/lm LEDs/each optic 1 Light colour White Required components: C13867_LENINA-STD-BASE-VERO29 C12606_LENINA-DL Bender Wirth: 431 Typ L3</p>	

OPTICAL RESULTS (SIMULATED):



LED CXA/B 13xx
 FWHM / FWTM 15.0° / 31.0°
 Efficiency 91 %
 Peak intensity 6.6 cd/lm
 LEDs/each optic 1
 Light colour White
 Required components:
 C13868_LENINA-STD-BASE-VERO13-18
 C12606_LENINA-DL
 Bender Wirth: 448 Typ L1

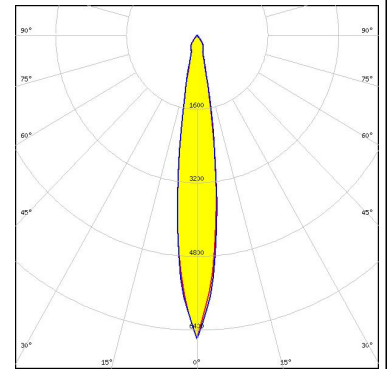

LED CXA/B 13xx
 FWHM / FWTM 12.0° / 21.0°
 Efficiency 94 %
 Peak intensity 11.8 cd/lm
 LEDs/each optic 1
 Light colour White
 Required components:
 C13868_LENINA-STD-BASE-VERO13-18
 Bender Wirth: 448 Typ L1

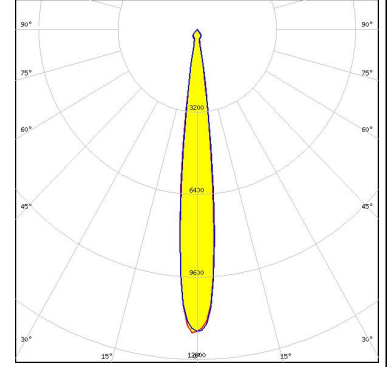

LED CXA/B 1830
 FWHM / FWTM 19.0° / 52.0°
 Efficiency 84 %
 Peak intensity 3.6 cd/lm
 LEDs/each optic 1
 Light colour White
 Required components:
 C14146_LENINA-STD-BASE-CXA18
 C12606_LENINA-DL

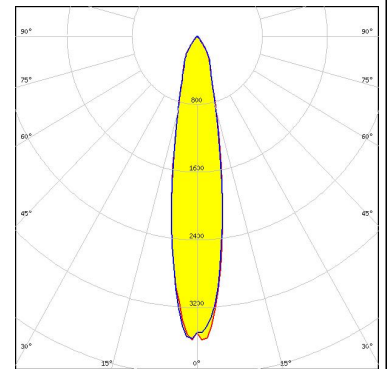

LED CXA/B 1830
 FWHM / FWTM 16.0°
 Efficiency 93 %
 Peak intensity 5.6 cd/lm
 LEDs/each optic 1
 Light colour White
 Required components:
 C14146_LENINA-STD-BASE-CXA18

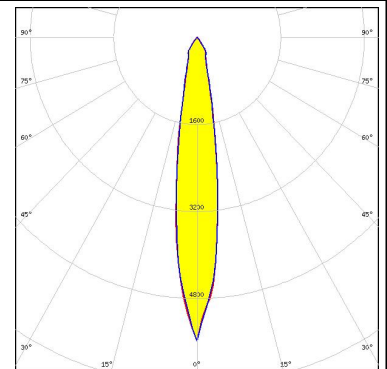

OPTICAL RESULTS (SIMULATED):



LED CXA/B 30xx
 FWHM / FWTM 19.0° / 58.0°
 Efficiency 84 %
 Peak intensity 3.3 cd/lm
 LEDs/each optic 1
 Light colour White
 Required components:
 C12606_LENINA-DL
 IDEAL: 50-2234C + 50-2100LN

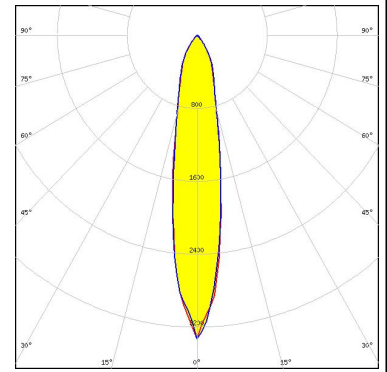

LED CXA/B 30xx
 FWHM / FWTM 18.0° / 53.0°
 Efficiency 90 %
 Peak intensity 4 cd/lm
 LEDs/each optic 1
 Light colour White
 Required components:
 IDEAL: 50-2234C + 50-2100LN

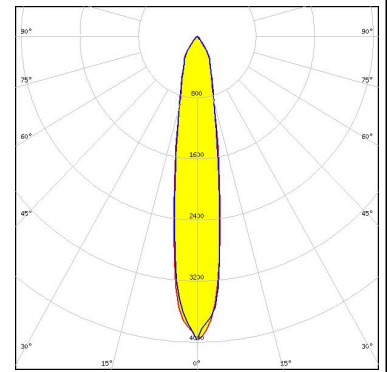

LED CxM-14 (19x19)
 FWHM / FWTM 17.0° / 41.0°
 Efficiency 87 %
 Peak intensity 4.5 cd/lm
 LEDs/each optic 1
 Light colour White
 Required components:
 C13868_LENINA-STD-BASE-VERO13-18
 C12606_LENINA-DL
 Bender Wirth: 433 Typ L1



LED CxM-14 (19x19)
 FWHM / FWTM 17.0° / 94.0°
 Efficiency 91 %
 Peak intensity 5.5 cd/lm
 LEDs/each optic 1
 Light colour White
 Required components:
 C13868_LENINA-STD-BASE-VERO13-18
 Bender Wirth: 433 Typ L1

OPTICAL RESULTS (SIMULATED):



LED CxM-9 (13.5x13.5)
 FWHM / FWTM 11.0° / 22.0°
 Efficiency 91 %
 Peak intensity 10.9 cd/lm
 LEDs/each optic 1
 Light colour White
 Required components:
 C13868_LENINA-STD-BASE-VERO13-18
 Bender Wirth: 434 Typ L1



LED CxM-9 (13.5x13.5)
 FWHM / FWTM 13.0° / 28.0°
 Efficiency 86 %
 Peak intensity 6.9 cd/lm
 LEDs/each optic 1
 Light colour White
 Required components:
 C13868_LENINA-STD-BASE-VERO13-18
 C12606_LENINA-DL
 Bender Wirth: 434 Typ L1



Opto Semiconductors

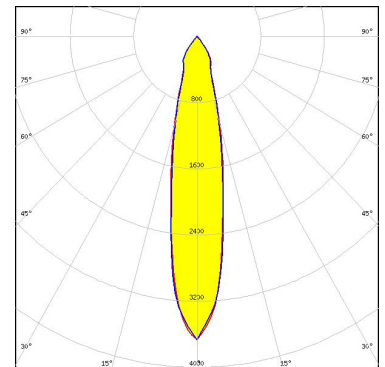

LED Soleriq S15
 FWHM / FWTM 20.0° / 56.0°
 Efficiency 91 %
 Peak intensity 3.7 cd/lm
 LEDs/each optic 1
 Light colour White
 Required components:
 C12691_LENINA-STD-BASE-CLL030



SEOUL SEMICONDUCTOR

LED ZC12/18
 FWHM / FWTM 17.0° / 41.0°
 Efficiency 87 %
 Peak intensity 4.5 cd/lm
 LEDs/each optic 1
 Light colour White
 Required components:
 C13868_LENINA-STD-BASE-VERO13-18
 C12606_LENINA-DL
 Bender Wirth: 433 Typ L1

OPTICAL RESULTS (SIMULATED):

	
SEOL SEMICONDUCTOR	
LED	ZC12/18
FWHM / FWTM	17.0° / 34.0°
Efficiency	91 %
Peak intensity	5.5 cd/lm
LEDs/each optic	1
Light colour	White
Required components:	
C13868_LENINA-STD-BASE-VERO13-18	
Bender Wirth: 433 Typ L1	
<hr/>	
	
SEOL SEMICONDUCTOR	
LED	ZC4/6
FWHM / FWTM	11.0° / 22.0°
Efficiency	91 %
Peak intensity	10.9 cd/lm
LEDs/each optic	1
Light colour	White
Required components:	
C13868_LENINA-STD-BASE-VERO13-18	
Bender Wirth: 434 Typ L1	
<hr/>	
	
SEOL SEMICONDUCTOR	
LED	ZC4/6
FWHM / FWTM	13.0° / 28.0°
Efficiency	86 %
Peak intensity	6.9 cd/lm
LEDs/each optic	1
Light colour	White
Required components:	
C13868_LENINA-STD-BASE-VERO13-18	
C12606_LENINA-DL	
Bender Wirth: 434 Typ L1	

GENERAL INFORMATION:

NOTE: The typical beam angle will be changed by different color, chip size and chip position tolerance. The typical total beam angle is the full angle measured where the luminous intensity is half of the peak value.

Due to use of high power COB's with this product, special attention to proper thermal design is highly recommended. LEDiL has no liability for direct, indirect or consecutive damages arising from the LEDiL products being used outside of the recommended temperature range.

MATERIALS:

As part of our continuous research and improvement processes, and to ensure the best possible quality and availability of our products, LEDiL reserves the right to change material grades without notice.

PRODUCT DATA USER AGREEMENT AND DISCLAIMER:

The measured data in the provided downloadable LEDiL Product Datasheets and Mechanical 2D-Drawings is rounded and provided as reference for planning. LEDiL Oy's optical specifications have been verified by conducting performance testing of the products in accordance with the company's quality system. The reported data are averaged results of multiple measurements with typical variation. LEDiL Oy reserves the right to without prior notification make changes and improvements to its products.

LEDiL Oy assumes neither warranty, nor guarantee nor any other liability of any kind for the contents and correctness of the provided data. The provided data has been generated with highest diligence but the provided data may in reality not represent the complete possible variation range of all intrinsic parameters. Therefore, in certain cases a deviation from the provided data could occur.

LEDiL Oy reserves the right to undertake technical changes of its products without further notification which could lead to changes in the provided data. LEDiL Oy assumes no liability of any kind for the possible deviation from any provided data or any other damage resulting from the usage of the provided data.

The user agrees to this disclaimer and user agreement with the download or usage of the provided files.

LEDiL Oy

Joensuunkatu 13
FI-24240 SALO
Finland

LEDiL Inc.

228 West Page Street
Suite D
Sycamore IL 60178
USA

Ledil Optics Technology (Shenzhen) Co., Ltd.

405 , Block B
Casic Motor Building
Shenzhen 518057
P.R.CHINA

Local sales and technical support

[www.ledil.com/
where_to_buy](http://www.ledil.com/where_to_buy)

Shipping locations

Salo, Finland
Hong Kong, China

Distribution Partners

[www.ledil.com/
where_to_buy](http://www.ledil.com/where_to_buy)