

LENA-M

~20° medium beam

SPECIFICATION:

Dimensions	Ø 111.0 mm
Height	80 mm
Fastening	socket
ROHS compliant	yes ⓘ

MATERIALS:

Component	Type	Material	Colour	Finish	Coating
LENA-M	Reflector	PC	metal		lacquer





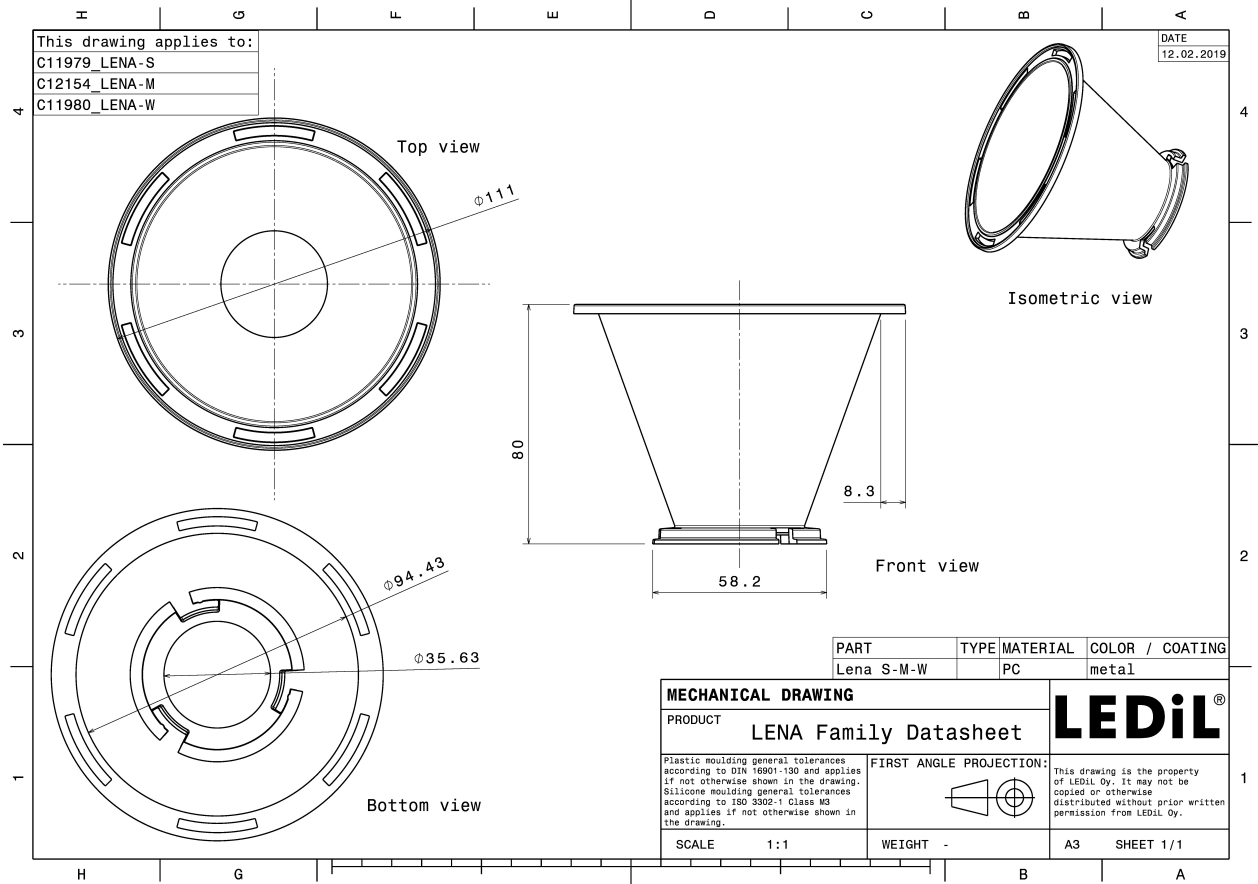

ORDERING INFORMATION:

Component	Qty in box	MOQ	MPQ	Box weight (kg)
C12154_LENA-M » Box size: 400 x 280 x 380 mm	60	60	60	4.0







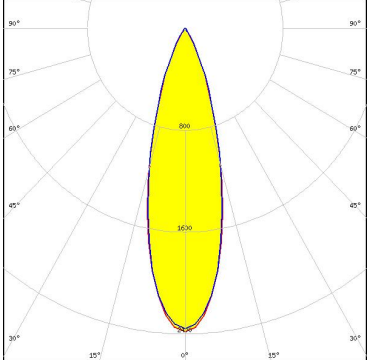

See also our general installation guide: www.ledil.com/installation_guide

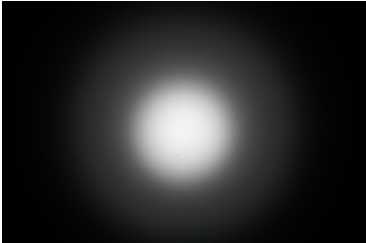
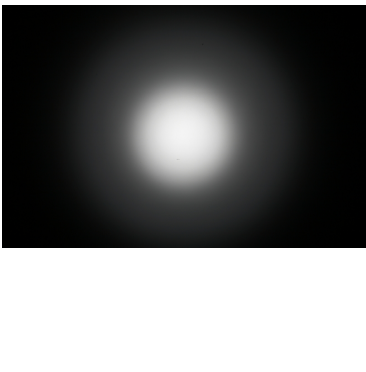
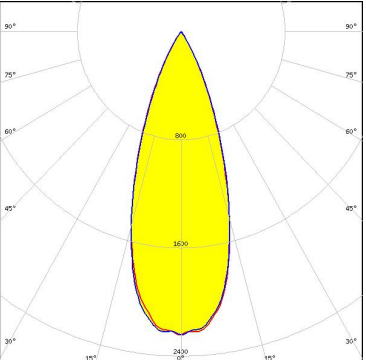

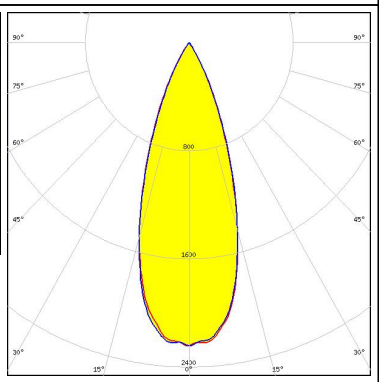

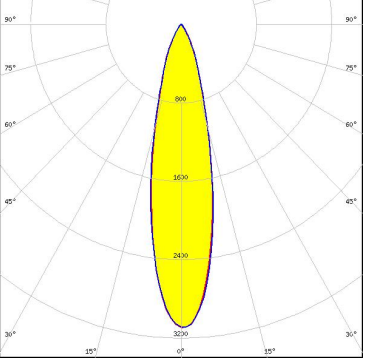
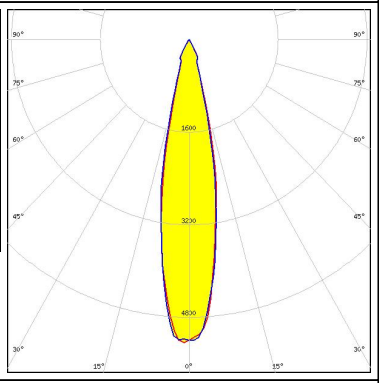

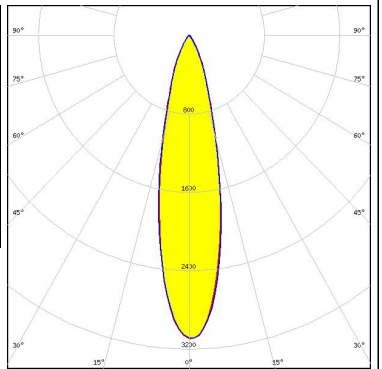

OPTICAL RESULTS (MEASURED):

	
LED	BXRA ES Rectangle
FWHM / FWTM	20.0° / 44.0°
Efficiency	77 %
LEDs/each optic	1
Light colour	White
Required components:	
C12153_LENA-STD-BASE-BXRA	
C11996_LENA-LENS	
	
LED	BXRA ES Rectangle
FWHM / FWTM	19.0° / 36.0°
Efficiency	83 %
LEDs/each optic	1
Light colour	White
Required components:	
C12153_LENA-STD-BASE-BXRA	
	
LED	BXRA RS
FWHM / FWTM	28.0°
Efficiency	84 %
LEDs/each optic	1
Light colour	White
Required components:	
C12229_LENA-STD-BASE-RS	
	
LED	BXRA RS
FWHM / FWTM	29.0°
Efficiency	79 %
LEDs/each optic	1
Light colour	White
Required components:	
C12229_LENA-STD-BASE-RS	
C11996_LENA-LENS	
	

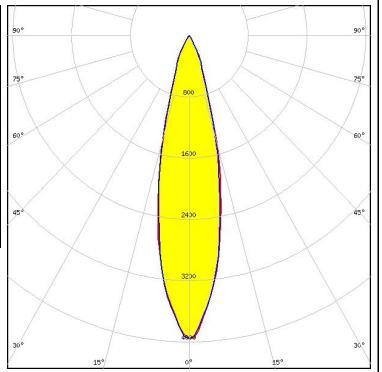
OPTICAL RESULTS (MEASURED):

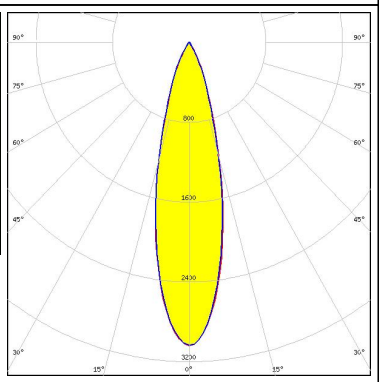
<p></p> <p>LED V10 Gen6 FWHM / FWTM 18.0° / 40.0° Efficiency 75 % Peak intensity 5.2 cd/lm LEDs/each optic 1 Light colour White</p> <p>Required components: C13186_LENA-STD-BASE-CXA15 C11996_LENA-LENS</p>		
<p></p> <p>LED Vero SE 29 FWHM / FWTM 36.0° / 59.0° Efficiency 87 % Peak intensity 2.2 cd/lm LEDs/each optic 1 Light colour White</p> <p>Required components: C15083_LENA-STD-BASE-VERO29</p>		
<p></p> <p>LED VERO13 FWHM / FWTM 21.0° / 36.0° Efficiency 88 % Peak intensity 5.2 cd/lm LEDs/each optic 1 Light colour White</p> <p>Required components: C13868_LENA-STD-BASE-VERO13-18</p>		
<p></p> <p>LED VERO13 FWHM / FWTM 24.0° / 53.0° Efficiency 81 % Peak intensity 3.1 cd/lm LEDs/each optic 1 Light colour White</p> <p>Required components: C13868_LENA-STD-BASE-VERO13-18 C11996_LENA-LENS</p>		

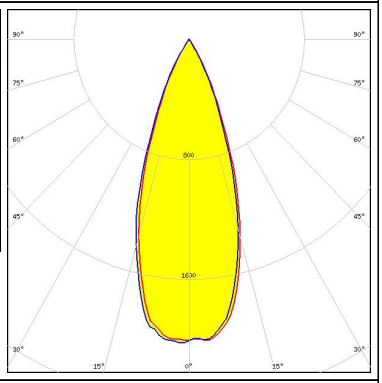
OPTICAL RESULTS (MEASURED):

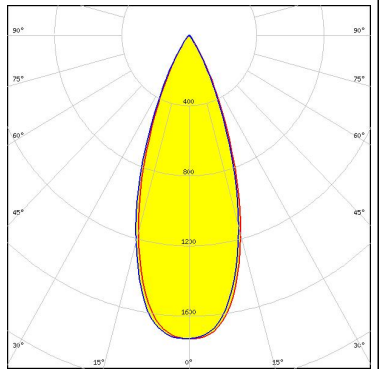
<p></p> <p>LED VERO18 FWHM / FWTM 24.0° / 59.0° Efficiency 86 % Peak intensity 4 cd/lm LEDs/each optic 1 Light colour White Required components: C13868_LENA-STD-BASE-VERO13-18</p>		
<p></p> <p>LED VERO18 FWHM / FWTM 26.0° / 52.0° Efficiency 81 % Peak intensity 3 cd/lm LEDs/each optic 1 Light colour White Required components: C13868_LENA-STD-BASE-VERO13-18 C11996_LENA-LENS</p>		
<p></p> <p>LED VERO29 FWHM / FWTM 38.0° / 60.0° Efficiency 82 % Peak intensity 2 cd/lm LEDs/each optic 1 Light colour White Required components: C13867_LENA-STD-BASE-VERO29</p>		
<p></p> <p>LED VERO29 FWHM / FWTM 38.0° / 62.0° Efficiency 77 % Peak intensity 1.7 cd/lm LEDs/each optic 1 Light colour White Required components: C13867_LENA-STD-BASE-VERO29 C11996_LENA-LENS</p>		

OPTICAL RESULTS (MEASURED):

CITIZEN

LED CL-L340
 FWHM / FWTM 24.0° / 50.0°
 Efficiency 78 %
 Peak intensity 3.8 cd/m
 LEDs/each optic 1
 Light colour White
 Required components:
 C11995_LENA-STD-BASE-CL340
 C11996_LENA-LENS

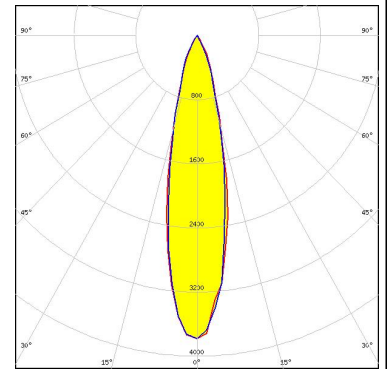

CITIZEN

LED CL-L340
 FWHM / FWTM 22.0° / 44.0°
 Efficiency 83 %
 Peak intensity 4.7 cd/m
 LEDs/each optic 1
 Light colour White
 Required components:
 C11995_LENA-STD-BASE-CL340

CITIZEN

LED CLL02x/CLU02x (LES10)
 FWHM / FWTM 17.0° / 31.0°
 Efficiency 83 %
 Peak intensity 6.6 cd/m
 LEDs/each optic 1
 Light colour White
 Required components:
 C13868_LENA-STD-BASE-VERO13-18
 Bender Wirth: 434 Typ L1

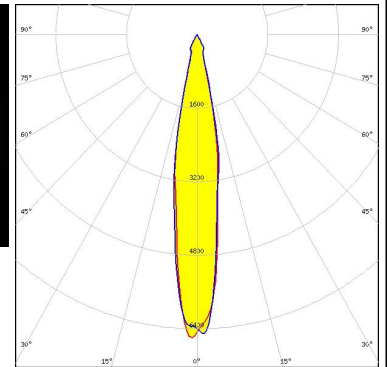

CITIZEN

LED CLL02x/CLU02x (LES10)
 FWHM / FWTM 20.0° / 44.0°
 Efficiency 78 %
 Peak intensity 4.3 cd/m
 LEDs/each optic 1
 Light colour White
 Required components:
 C13868_LENA-STD-BASE-VERO13-18
 C11996_LENA-LENS
 Bender Wirth: 434 Typ L1

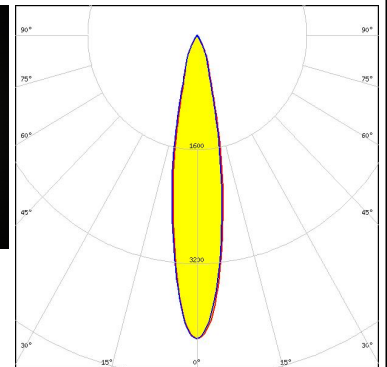

OPTICAL RESULTS (MEASURED):

CITIZEN

LED CLL03x/CLU03x
 FWHM / FWTM 20.0° / 38.0°
 Efficiency 83 %
 Peak intensity 5.1 cd/lm
 LEDs/each optic 1
 Light colour White
 Required components:
 C12691_LENA-STD-BASE-CLL030

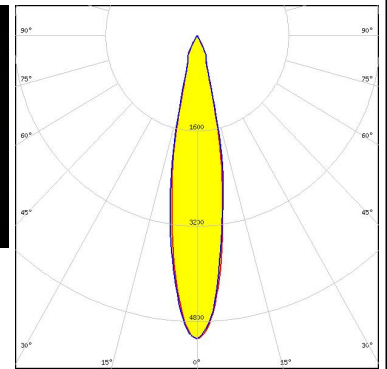
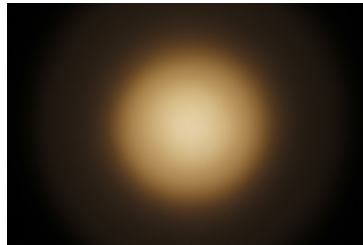

CITIZEN

LED CLL03x/CLU03x
 FWHM / FWTM 22.0° / 49.0°
 Efficiency 76 %
 Peak intensity 3.5 cd/lm
 LEDs/each optic 1
 Light colour White
 Required components:
 C11996_LENA-LENS
 A.A.G. STUCCHI: 8101-G2 + S-8000-11

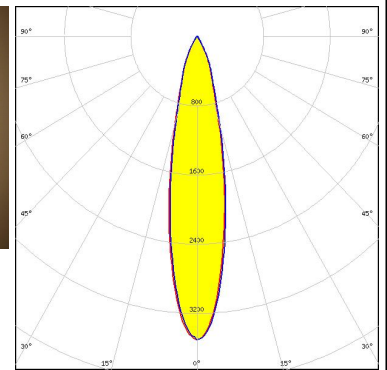
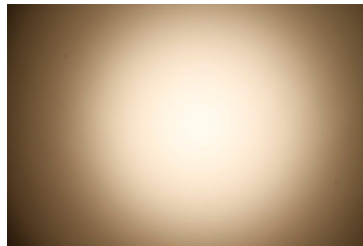

CITIZEN

LED CLL03x/CLU03x
 FWHM / FWTM 20.0° / 37.0°
 Efficiency 81 %
 Peak intensity 5.2 cd/lm
 LEDs/each optic 1
 Light colour White
 Required components:
 A.A.G. STUCCHI: 8101-G2 + S-8000-11

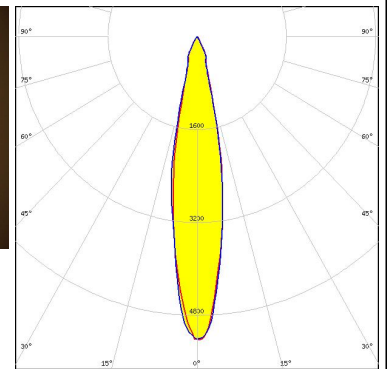
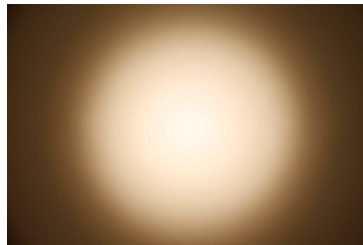

CITIZEN

LED CLL03x/CLU03x
 FWHM / FWTM 23.0° / 50.0°
 Efficiency 78 %
 Peak intensity 3.4 cd/lm
 LEDs/each optic 1
 Light colour White
 Required components:
 C13868_LENA-STD-BASE-VERO13-18
 C11996_LENA-LENS
 Bender Wirth: 433 Typ L1

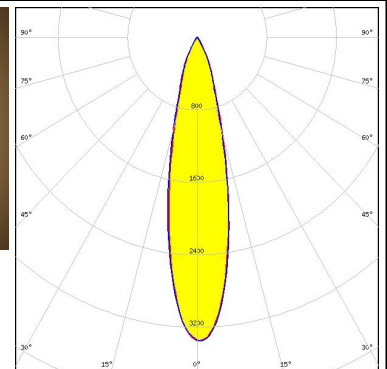
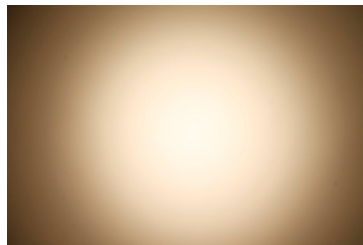

OPTICAL RESULTS (MEASURED):

CITIZEN

LED CLL03x/CLU03x
 FWHM / FWTM 22.0° / 48.0°
 Efficiency 78 %
 Peak intensity 3.7 cd/lm
 LEDs/each optic 1
 Light colour White
 Required components:
 C12691_LENA-STD-BASE-CLL030
 C11996_LENA-LENS

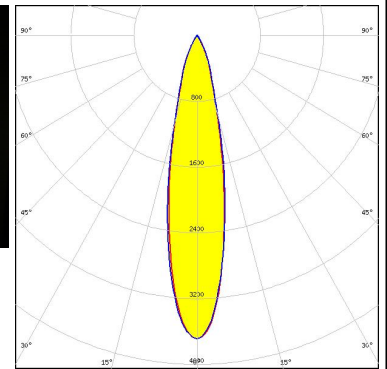
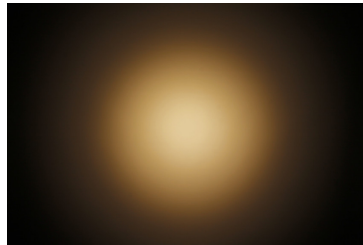

CITIZEN

LED CLL03x/CLU03x
 FWHM / FWTM 22.0° / 39.0°
 Efficiency 83 %
 Peak intensity 4.7 cd/lm
 LEDs/each optic 1
 Light colour White
 Required components:
 C13868_LENA-STD-BASE-VERO13-18
 Bender Wirth: 433 Typ L1

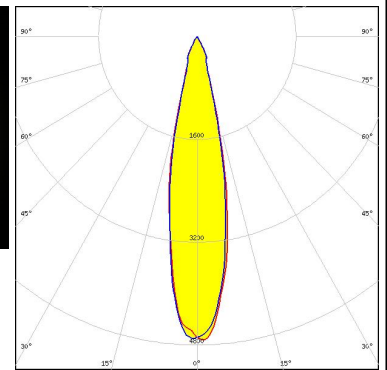

CITIZEN

LED CLL04x/CLU04x
 FWHM / FWTM 27.0° / 53.0°
 Efficiency 83 %
 Peak intensity 3.3 cd/lm
 LEDs/each optic 1
 Light colour White
 Required components:
 C13867_LENA-STD-BASE-VERO29
 Bender Wirth: 431 Typ L3

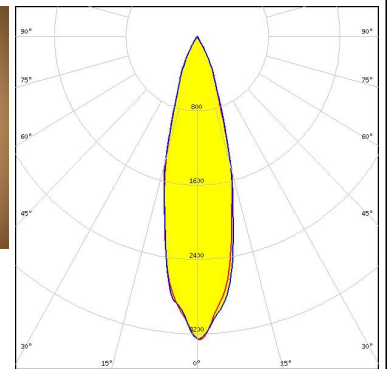
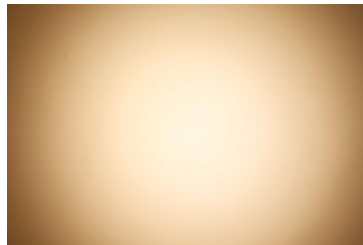

CITIZEN

LED CLL04x/CLU04x
 FWHM / FWTM 27.0° / 56.0°
 Efficiency 78 %
 Peak intensity 2.5 cd/lm
 LEDs/each optic 1
 Light colour White
 Required components:
 C11996_LENA-LENS
 IDEAL: 50-2204CT + 50-2100LN

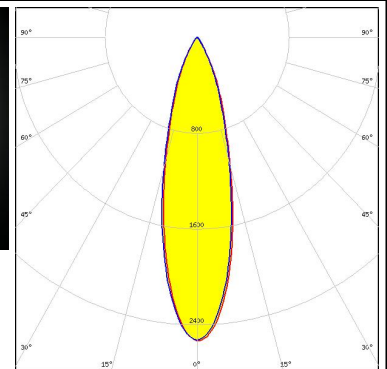

OPTICAL RESULTS (MEASURED):

CITIZEN

LED CLL04x/CLU04x
 FWHM / FWTM 24.0° / 52.0°
 Efficiency 80 %
 Peak intensity 3.6 cd/m
 LEDs/each optic 1
 Light colour White
 Required components:
 IDEAL: 50-2204CT + 50-2100LN

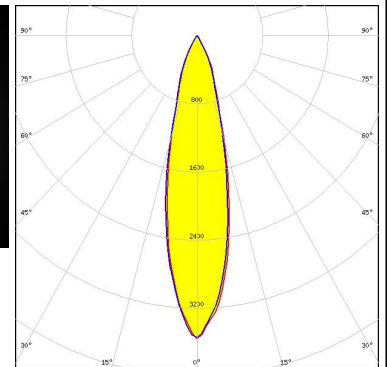

CITIZEN

LED CLL04x/CLU04x
 FWHM / FWTM 24.0° / 52.0°
 Efficiency 77 %
 Peak intensity 2.7 cd/m
 LEDs/each optic 1
 Light colour White
 Required components:
 C12692_LENA-STD-BASE-CLL040
 C11996_LENA-LENS



CITIZEN

LED CLL04x/CLU04x
 FWHM / FWTM 30.0° / 51.0°
 Efficiency 78 %
 Peak intensity 2.3 cd/m
 LEDs/each optic 1
 Light colour White
 Required components:
 C13867_LENA-STD-BASE-VERO29
 C11996_LENA-LENS
 Bender Wirth: 431 Typ L3

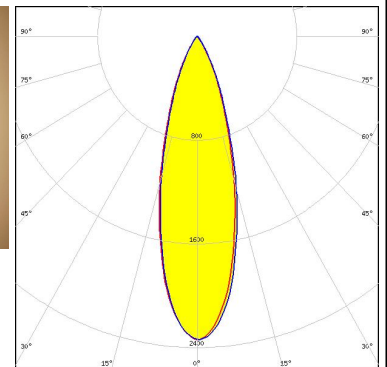
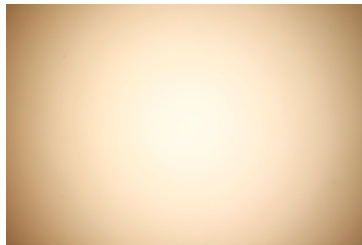

CITIZEN

LED CLL04x/CLU04x
 FWHM / FWTM 30.0° / 62.0°
 Efficiency 71 %
 Peak intensity 1.8 cd/m
 LEDs/each optic 1
 Light colour White
 Required components:
 C11996_LENA-LENS
 A.A.G. STUCCHI: 8102-G2 + S-8000-12

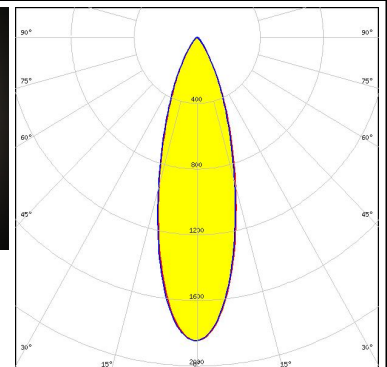
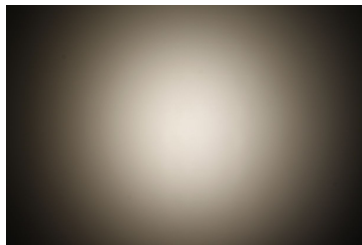

OPTICAL RESULTS (MEASURED):

CITIZEN

LED CLL04x/CLU04x
 FWHM / FWTM 26.0° / 53.0°
 Efficiency 88 %
 Peak intensity 3.3 cd/m
 LEDs/each optic 1
 Light colour White
 Required components:
 C12692_LENA-STD-BASE-CLL040

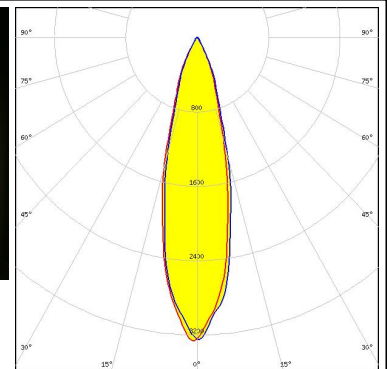

CITIZEN

LED CLL04x/CLU04x
 FWHM / FWTM 25.0° / 52.0°
 Efficiency 76 %
 Peak intensity 3.3 cd/m
 LEDs/each optic 1
 Light colour White
 Required components:
 A.A.G. STUCCHI: 8102-G2 + S-8000-12

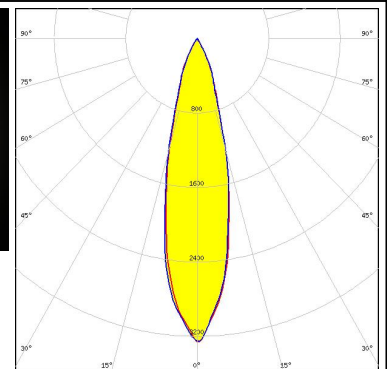
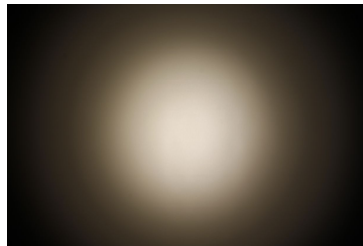

CITIZEN

LED CLU700/701/702/703
 FWHM / FWTM 16.0° / 37.0°
 Efficiency 78 %
 Peak intensity 5.5 cd/m
 LEDs/each optic 1
 Light colour White
 Required components:
 C13868_LENA-STD-BASE-VERO13-18
 C11996_LENA-LENS
 Bender Wirth: 434 Typ L1

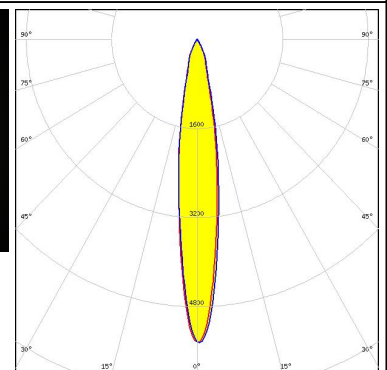

CITIZEN

LED CLU710/711
 FWHM / FWTM 18.0° / 43.0°
 Efficiency 81 %
 Peak intensity 4.3 cd/m
 LEDs/each optic 1
 Light colour White
 Required components:
 C12691_LENA-STD-BASE-CLL030
 C11996_LENA-LENS

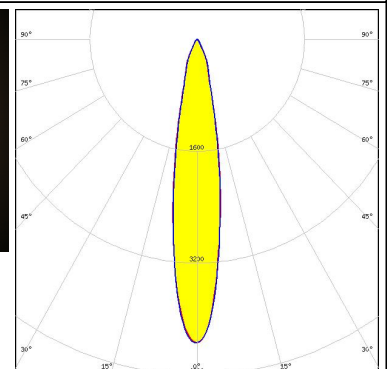
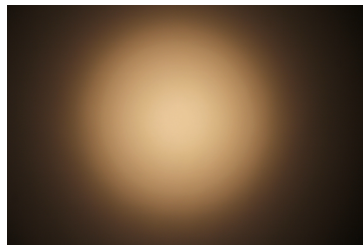

OPTICAL RESULTS (MEASURED):

CITIZEN

LED CLU710/711
 FWHM / FWTM 16.0° / 29.0°
 Efficiency 86 %
 Peak intensity 7.2 cd/lm
 LEDs/each optic 1
 Light colour White
 Required components:
 C12691_LENA-STD-BASE-CLL030

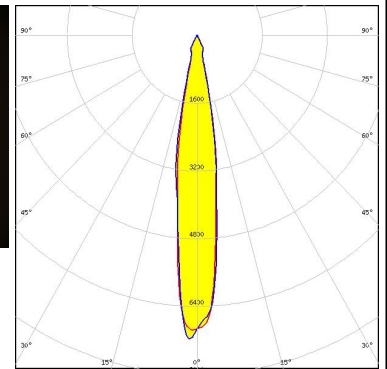
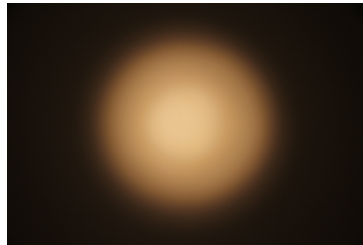

CITIZEN

LED CLU720/721/723
 FWHM / FWTM 20.0° / 48.0°
 Efficiency 77 %
 Peak intensity 3.7 cd/lm
 LEDs/each optic 1
 Light colour White
 Required components:
 C12691_LENA-STD-BASE-CLL030
 C11996_LENA-LENS

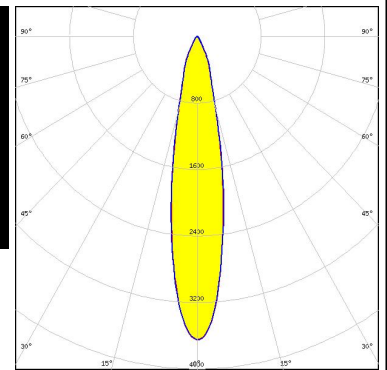
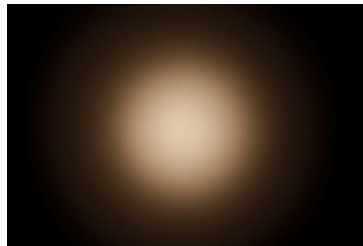

CITIZEN

LED CLU720/721/723
 FWHM / FWTM 18.0° / 32.0°
 Efficiency 83 %
 Peak intensity 5.7 cd/lm
 LEDs/each optic 1
 Light colour White
 Required components:
 C12691_LENA-STD-BASE-CLL030

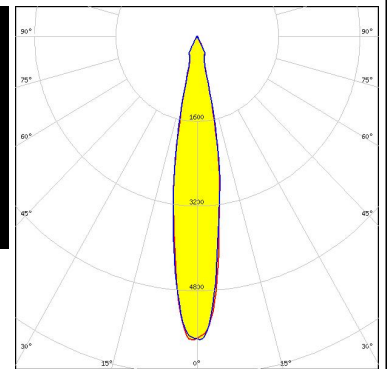
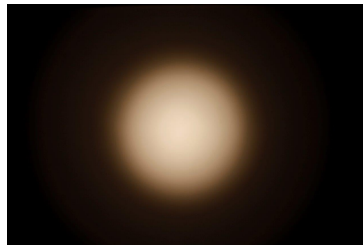





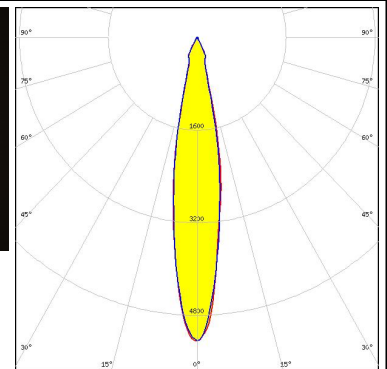
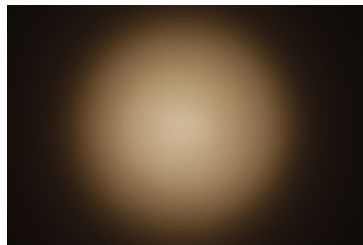

CITIZEN

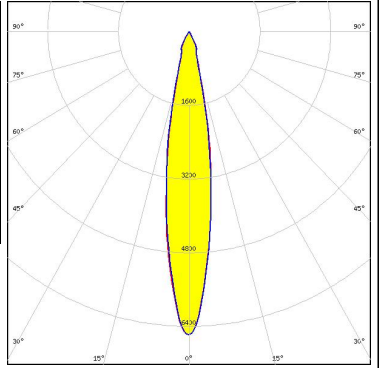
LED CLU730/731/733
 FWHM / FWTM 19.0° / 34.0°
 Efficiency 80 %
 Peak intensity 5.2 cd/lm
 LEDs/each optic 1
 Light colour White
 Required components:
 C12692_LENA-STD-BASE-CLL040

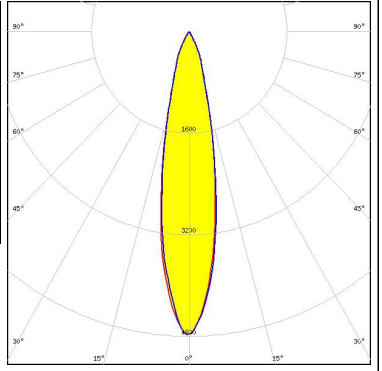

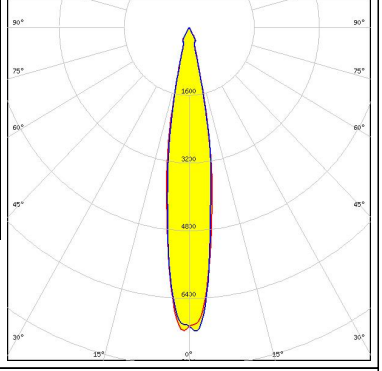
OPTICAL RESULTS (MEASURED):

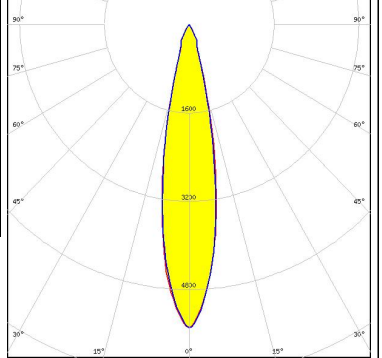
<p>CREE LEDs</p> <p>LED CMA1840 FWHM / FWTM 18.0° / 34.0° Efficiency 90 % Peak intensity 6.6 cd/lm LEDs/each optic 1 Light colour White Required components: C14146_LENA-STD-BASE-CXA18</p>		
<p>CREE LEDs</p> <p>LED CMA2550 FWHM / FWTM 21.0° / 47.0° Efficiency 90 % Peak intensity 4.8 cd/lm LEDs/each optic 1 Light colour White Required components: C13324_LENA-STD-BASE-CXA25</p>		
<p>CREE LEDs</p> <p>LED CMT14xx FWHM / FWTM 17.0° / 31.0° Efficiency 90 % Peak intensity 7.2 cd/lm LEDs/each optic 1 Light colour White Required components: C13868_LENA-STD-BASE-VERO13-18 Bender Wirth: 434 Typ L1</p>		
<p>CREE LEDs</p> <p>LED CMT19xx FWHM / FWTM 21.0° / 38.0° Efficiency 90 % Peak intensity 5.5 cd/lm LEDs/each optic 1 Light colour White Required components: C13868_LENA-STD-BASE-VERO13-18 Bender Wirth: 477 Typ L1</p>		

OPTICAL RESULTS (MEASURED):



LED CMT19xx
 FWHM / FWTM 20.0° / 37.0°
 Efficiency 90 %
 Peak intensity 5.8 cd/m
 LEDs/each optic 1
 Light colour White
 Required components:
 C12691_LENA-STD-BASE-CLL030

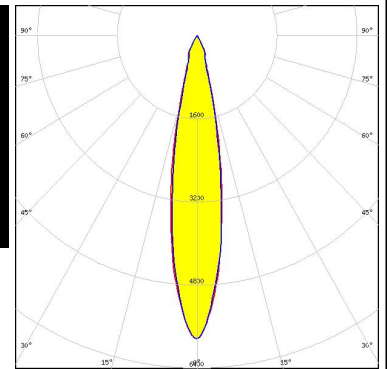
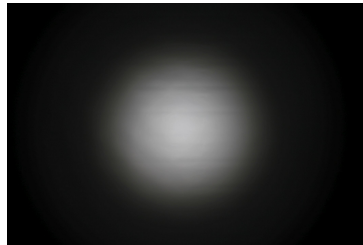

LED CMT28xx
 FWHM / FWTM 26.0° / 52.0°
 Efficiency 90 %
 Peak intensity 3.6 cd/m
 LEDs/each optic 1
 Light colour White
 Required components:
 C13867_LENA-STD-BASE-VERO29
 Bender Wirth: 471 Typ L3

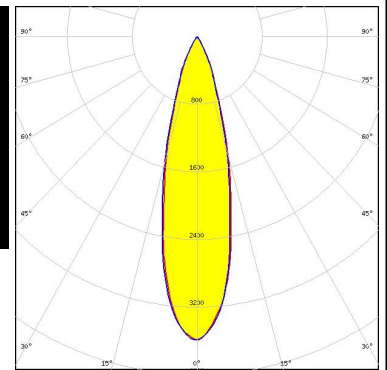
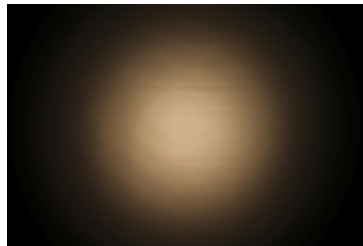

LED CMT28xx
 FWHM / FWTM 25.0° / 51.0°
 Efficiency 90 %
 Peak intensity 3.8 cd/m
 LEDs/each optic 1
 Light colour White
 Required components:
 C12692_LENA-STD-BASE-CLL040

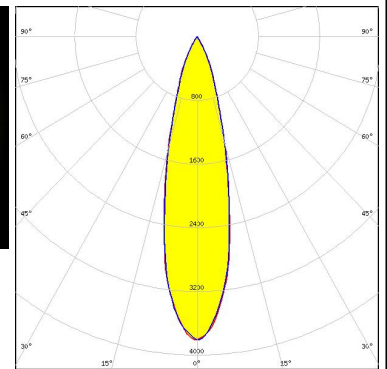
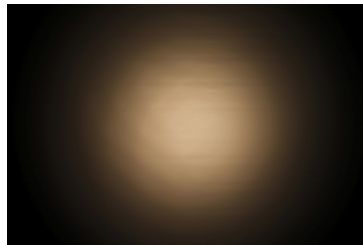

LED CXA/B 15xx
 FWHM / FWTM 17.0° / 36.0°
 Efficiency 79 %
 Peak intensity 5.3 cd/m
 LEDs/each optic 1
 Light colour White
 Required components:
 C13186_LENA-STD-BASE-CXA15
 C11996_LENA-LENS

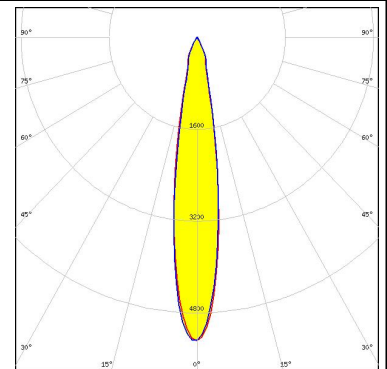

OPTICAL RESULTS (MEASURED):



LED CXA/B 15xx
 FWHM / FWTM 18.0° / 37.0°
 Efficiency 78 %
 Peak intensity 5.1 cd/lm
 LEDs/each optic 1
 Light colour White

Required components:

C13868_LENA-STD-BASE-VERO13-18
 C11996_LENA-LENS
 Bender Wirth: 441 Typ L1

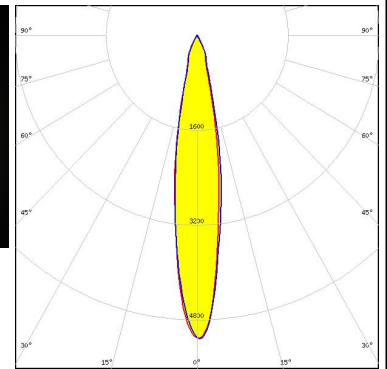

LED CXA/B 15xx
 FWHM / FWTM 16.0° / 27.0°
 Efficiency 84 %
 Peak intensity 7.5 cd/lm
 LEDs/each optic 1
 Light colour White

Required components:

C13186_LENA-STD-BASE-CXA15

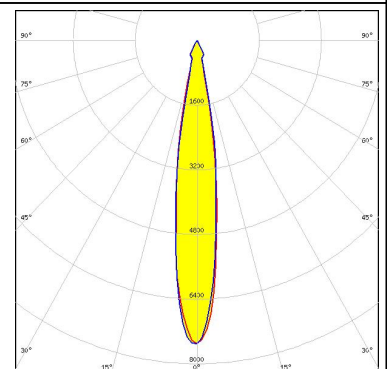

LED CXA/B 1816 & CXA/B 1820 & CXA 1850
 FWHM / FWTM 22.0° / 49.0°
 Efficiency 80 %
 Peak intensity 3.7 cd/lm
 LEDs/each optic 1
 Light colour White

Required components:

C13868_LENA-STD-BASE-VERO13-18
 C11996_LENA-LENS
 Bender Wirth: 437 Typ L1

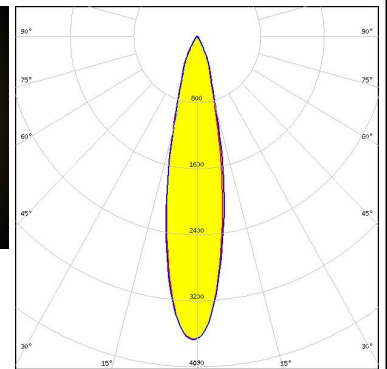
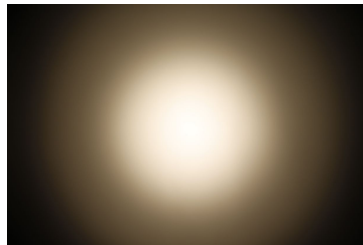



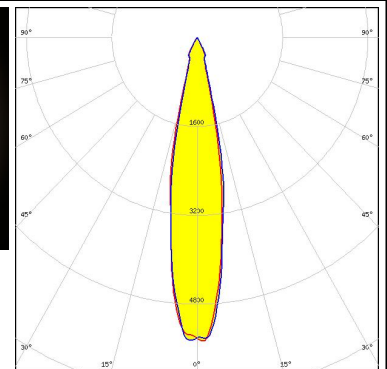

LED CXA/B 1816 & CXA/B 1820 & CXA 1850
 FWHM / FWTM 21.0° / 35.0°
 Efficiency 85 %
 Peak intensity 5.3 cd/lm
 LEDs/each optic 1
 Light colour White

Required components:

C13868_LENA-STD-BASE-VERO13-18
 Bender Wirth: 437 Typ L1

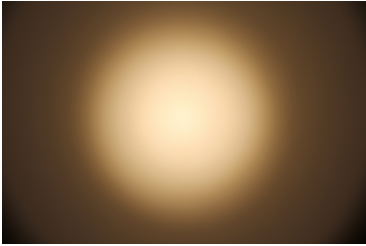

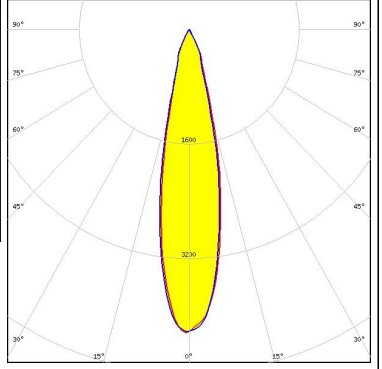
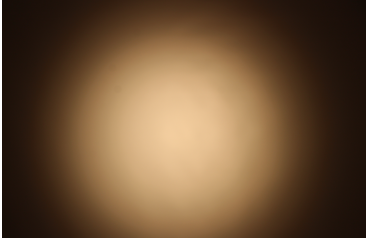
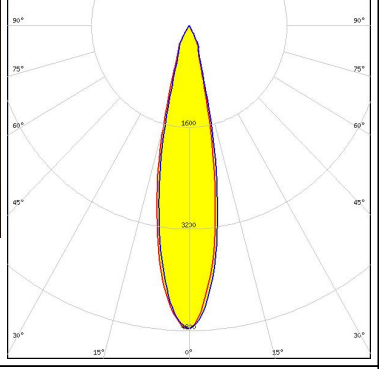
OPTICAL RESULTS (MEASURED):

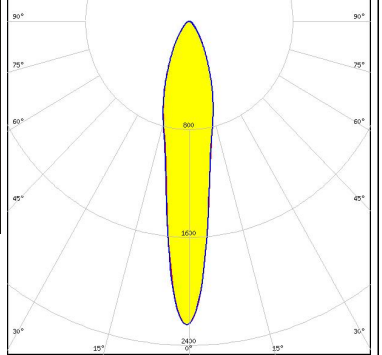
<p>CREE LEDs</p> <p>LED CXA/B 1816 & CXA/B 1820 & CXA 1850</p> <p>FWHM / FWTM 17.0° / 32.0°</p> <p>Efficiency 84 %</p> <p>Peak intensity 7.9 cd/m</p> <p>LEDs/each optic 1</p> <p>Light colour White</p> <p>Required components: C14146_LENA-STD-BASE-CXA18</p>		
<p>CREE LEDs</p> <p>LED CXA/B 1830</p> <p>FWHM / FWTM 23.0° / 47.0°</p> <p>Efficiency 83 %</p> <p>Peak intensity 4.3 cd/m</p> <p>LEDs/each optic 1</p> <p>Light colour White</p> <p>Required components: C13868_LENA-STD-BASE-VERO13-18 C14169_LENA-CLEAR-LENS Bender Wirth: 437 Typ L1</p>		
<p>CREE LEDs</p> <p>LED CXA/B 1830</p> <p>FWHM / FWTM 23.0° / 42.0°</p> <p>Efficiency 88 %</p> <p>Peak intensity 4.8 cd/m</p> <p>LEDs/each optic 1</p> <p>Light colour White</p> <p>Required components: C13868_LENA-STD-BASE-VERO13-18 Bender Wirth: 437 Typ L1</p>		
<p>CREE LEDs</p> <p>LED CXA/B 1830</p> <p>FWHM / FWTM 17.0° / 62.0°</p> <p>Efficiency 75 %</p> <p>Peak intensity 2.3 cd/m</p> <p>LEDs/each optic 1</p> <p>Light colour White</p> <p>Required components: C13868_LENA-STD-BASE-VERO13-18 C12231_LENA-FRESNEL Bender Wirth: 437 Typ L1</p>		

OPTICAL RESULTS (MEASURED):



LED CXA/B 25xx
 FWHM / FWTM 21.0° / 49.0°
 Efficiency 77 %
 Peak intensity 3.4 cd/lm
 LEDs/each optic 1
 Light colour White
 Required components:
 C13324_LENA-STD-BASE-CXA25
 C11996_LENA-LENS



LED CXA/B 25xx
 FWHM / FWTM 20.0° / 48.0°
 Efficiency 82 %
 Peak intensity 4.4 cd/lm
 LEDs/each optic 1
 Light colour White
 Required components:
 C13324_LENA-STD-BASE-CXA25

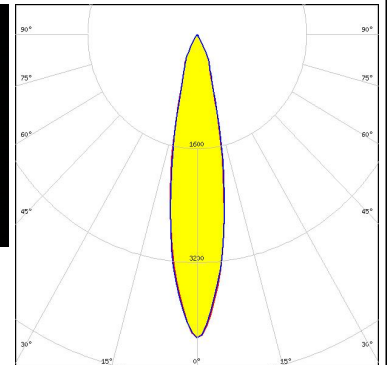

LED CXA2011
 FWHM / FWTM 19.0° / 44.0°
 Efficiency 78 %
 Peak intensity 4.1 cd/lm
 LEDs/each optic 1
 Light colour White
 Required components:
 C12105_LENA-STD-BASE-CXA20
 C11996_LENA-LENS

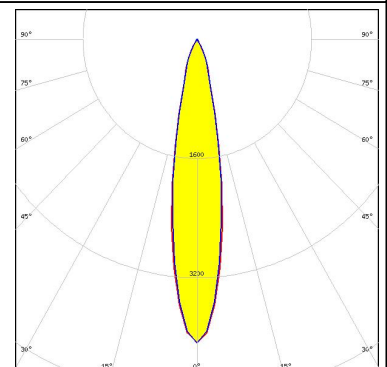

LED CHI3030 19W
 FWHM / FWTM 27.0° / 55.0°
 Efficiency 81 %
 Peak intensity 2.9 cd/lm
 LEDs/each optic 1
 Light colour White
 Required components:
 C13867_LENA-STD-BASE-VERO29
 C11996_LENA-LENS
 Bender Wirth: 468 Typ L3

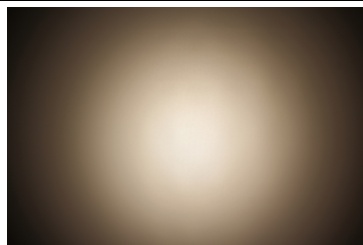

OPTICAL RESULTS (MEASURED):

EVERLIGHT

LED CHI3030 29W
 FWHM / FWTM 34.0° / 62.0°
 Efficiency 78 %
 Peak intensity 1.9 cd/m
 LEDs/each optic 1
 Light colour White

Required components:

C13867_LENA-STD-BASE-VERO29
 C11996_LENA-LENS
 Bender Wirth: 468 Typ L3

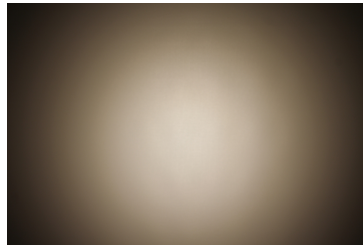

LUMILEDS

LED LUXEON CoB 1204/1205
 FWHM / FWTM 21.0° / 49.0°
 Efficiency 74 %
 Peak intensity 3.4 cd/m
 LEDs/each optic 1
 Light colour White

Required components:

C12292_LENA-STD-BASE-MEZ
 C11996_LENA-LENS

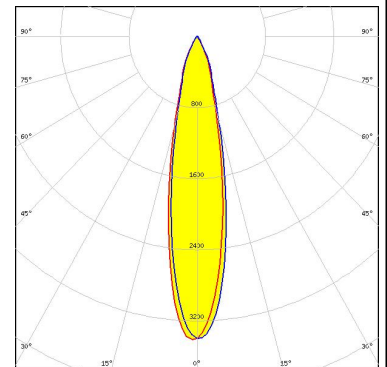

LUMILEDS

LED LUXEON CoB 1204/1205
 FWHM / FWTM 19.0° / 36.0°
 Efficiency 79 %
 Peak intensity 5.1 cd/m
 LEDs/each optic 1
 Light colour White

Required components:

C12292_LENA-STD-BASE-MEZ

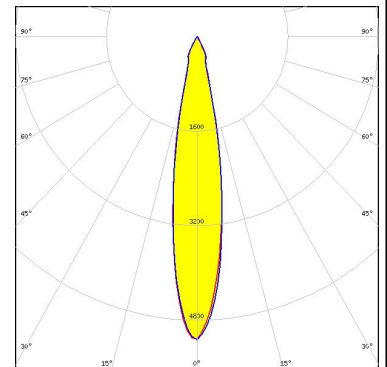

LUMILEDS

LED LUXEON CoB 1204HD
 FWHM / FWTM 15.0° / 28.0°
 Efficiency 90 %
 Peak intensity 8.3 cd/m
 LEDs/each optic 1
 Light colour White

Required components:

C11981_LENA-STD-BASE-COB-L110

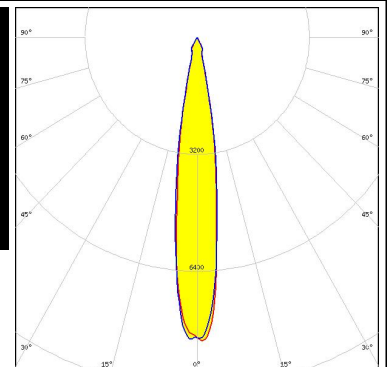
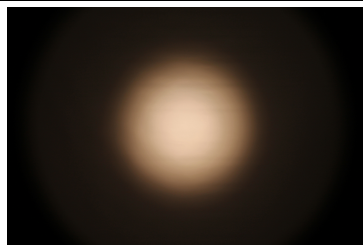

OPTICAL RESULTS (MEASURED):

LUMILEDS

LED LUXEON CoB 1205HD
 FWHM / FWTM 17.0° / 31.0°
 Efficiency 90 %
 Peak intensity 7.3 cd/lm
 LEDs/each optic 1
 Light colour White
 Required components:
 C11981_LENA-STD-BASE-COB-L110

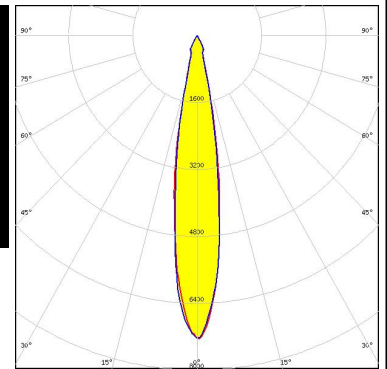

LUMILEDS

LED LUXEON CoB 1208
 FWHM / FWTM 21.0° / 41.0°
 Efficiency 80 %
 Peak intensity 4.5 cd/lm
 LEDs/each optic 1
 Light colour White
 Required components:
 C12292_LENA-STD-BASE-MEZ

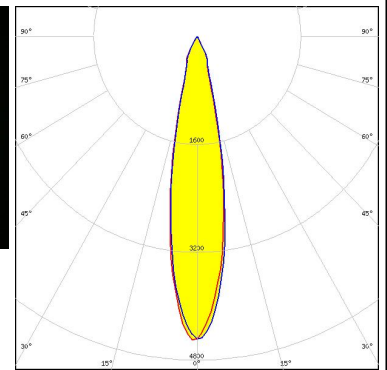

LUMILEDS

LED LUXEON CoB 1208
 FWHM / FWTM 23.0° / 52.0°
 Efficiency 74 %
 Peak intensity 3.1 cd/lm
 LEDs/each optic 1
 Light colour White
 Required components:
 C12292_LENA-STD-BASE-MEZ
 C11996_LENA-LENS

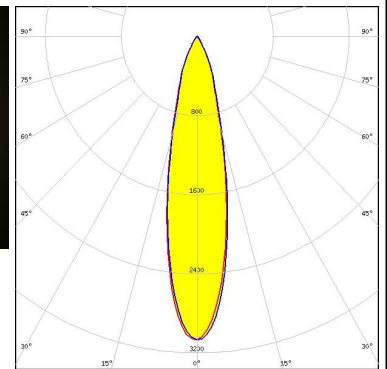

LUMILEDS



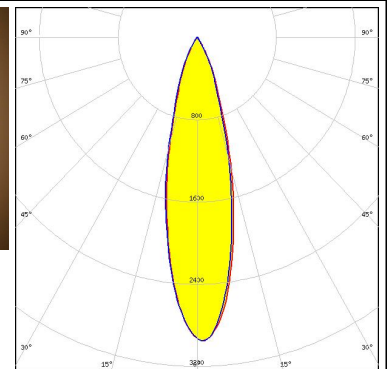
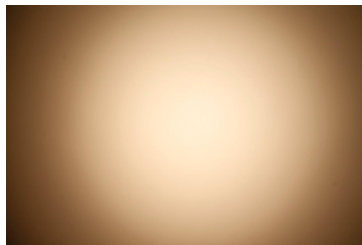

LED LUXEON CoB 1211
 FWHM / FWTM 26.0° / 53.0°
 Efficiency 78 %
 Peak intensity 3 cd/lm
 LEDs/each optic 1
 Light colour White
 Required components:
 C13867_LENA-STD-BASE-VERO29
 C11996_LENA-LENS
 Bender Wirth: 431 Typ L3

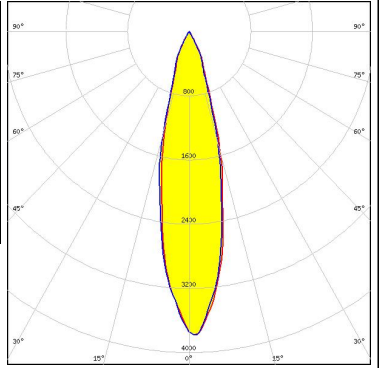
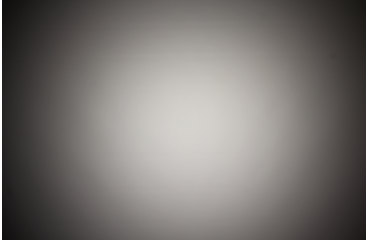
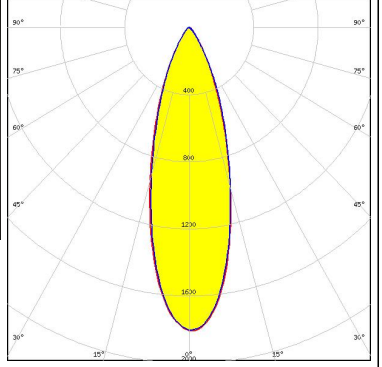
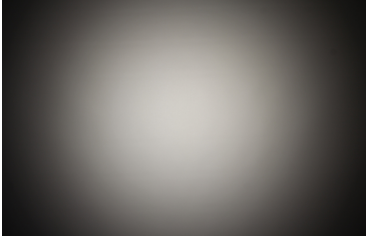
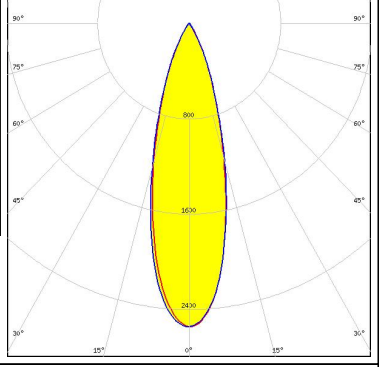
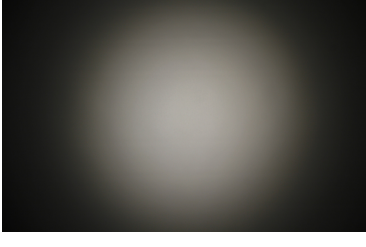
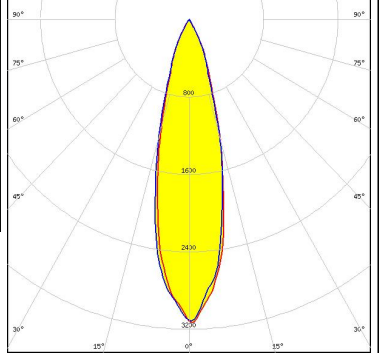

OPTICAL RESULTS (MEASURED):

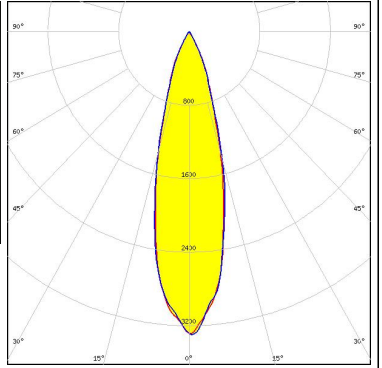
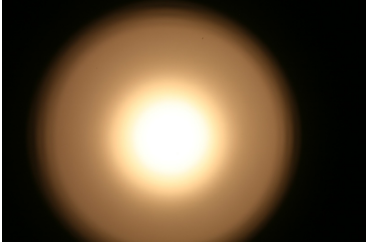
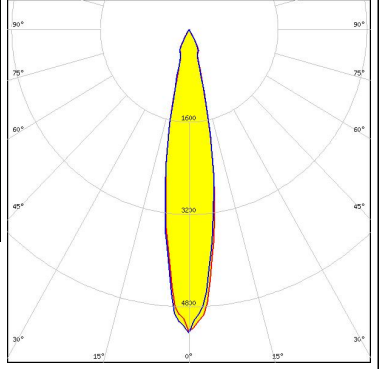
<p>LUMILEDS</p> <p>LED LUXEON CoB 1211 FWHM / FWTM 24.0° / 50.0° Efficiency 87 % Peak intensity 3.8 cd/m LEDs/each optic 1 Light colour White</p> <p>Required components: C13867_LENA-STD-BASE-VERO29 Bender Wirth: 431 Typ L3</p>		
<p>LUMILEDS</p> <p>LED LUXEON CoB 1213/1216/1812 FWHM / FWTM 31.0° / 63.0° Efficiency 72 % Peak intensity 1.8 cd/m LEDs/each optic 1 Light colour White</p> <p>Required components: C11996_LENA-LENS A.A.G. STUCCHI: 8102-G2 + S-8000-12</p>		
<p>LUMILEDS</p> <p>LED LUXEON CoB 1213/1216/1812 FWHM / FWTM 29.0° / 55.0° Efficiency 80 % Peak intensity 3.6 cd/m LEDs/each optic 1 Light colour White</p> <p>Required components: C12692_LENA-STD-BASE-CLL040 C11996_LENA-LENS</p>		
<p>LUMILEDS</p> <p>LED LUXEON CoB 1213/1216/1812 FWHM / FWTM 26.0° / 52.0° Efficiency 77 % Peak intensity 3.1 cd/m LEDs/each optic 1 Light colour White</p> <p>Required components: A.A.G. STUCCHI: 8102-G2 + S-8000-12</p>		

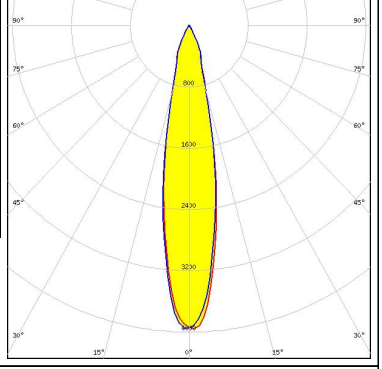

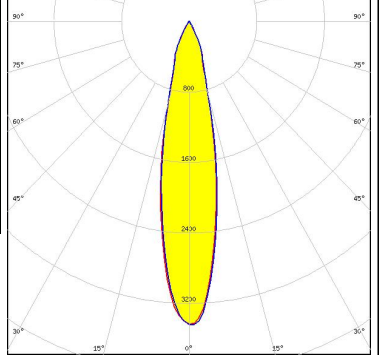

OPTICAL RESULTS (MEASURED):

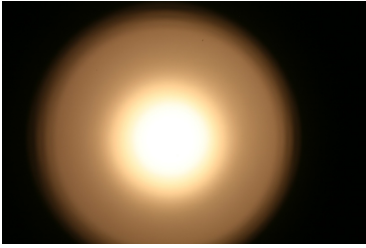
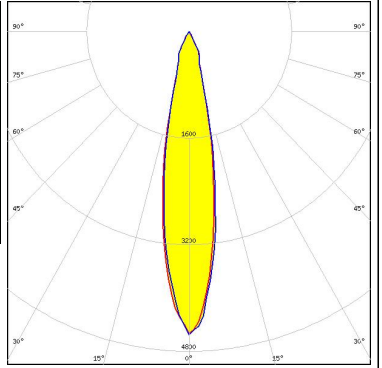
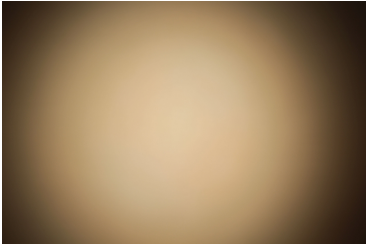
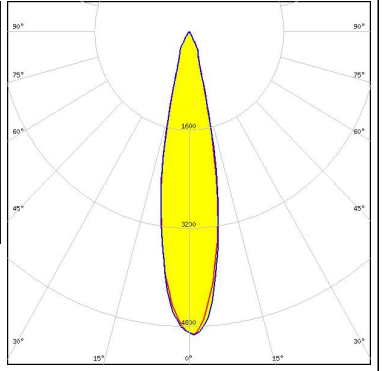
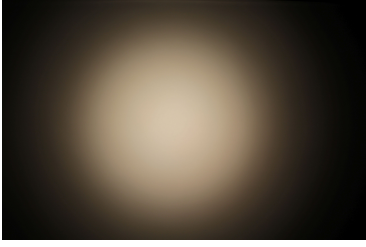
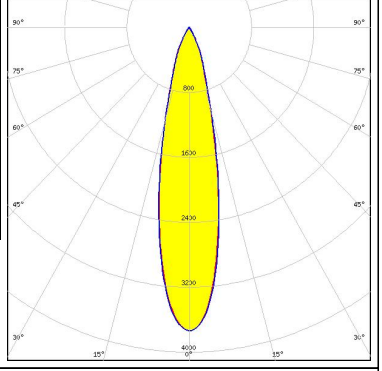
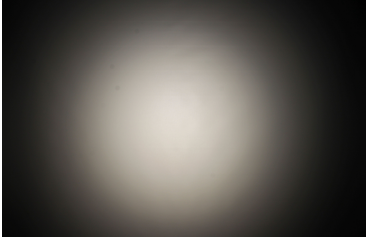
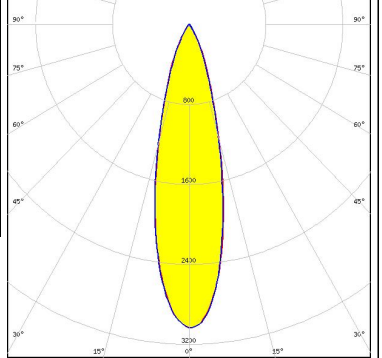
<p>LUMILEDS</p> <p>LED LUXEON CoB 1213/1216/1812</p> <p>FWHM / FWTM 27.0° / 52.0°</p> <p>Efficiency 83 %</p> <p>Peak intensity 3.3 cd/lm</p> <p>LEDs/each optic 1</p> <p>Light colour White</p> <p>Required components: C12692_LENA-STD-BASE-CLL040</p>		
<p>LUMILEDS</p> <p>LED LUXEON K12</p> <p>FWHM / FWTM 19.0° / 36.0°</p> <p>Efficiency 80 %</p> <p>Peak intensity 0.5 cd/lm</p> <p>LEDs/each optic 1</p> <p>Light colour White</p> <p>Required components: C12924_LENA-STD-BASE-LUXEON-K</p>		
<p>LUMILEDS</p> <p>LED LUXEON K12</p> <p>FWHM / FWTM 21.0° / 47.0°</p> <p>Efficiency 74 %</p> <p>Peak intensity 4 cd/lm</p> <p>LEDs/each optic 1</p> <p>Light colour White</p> <p>Required components: C12924_LENA-STD-BASE-LUXEON-K C11996_LENA-LENS</p>		
<p>LUMILEDS</p> <p>LED LUXEON K16</p> <p>FWHM / FWTM 22.0° / 48.0°</p> <p>Efficiency 72 %</p> <p>Peak intensity 3.5 cd/lm</p> <p>LEDs/each optic 1</p> <p>Light colour White</p> <p>Required components: C12924_LENA-STD-BASE-LUXEON-K C11996_LENA-LENS</p>		



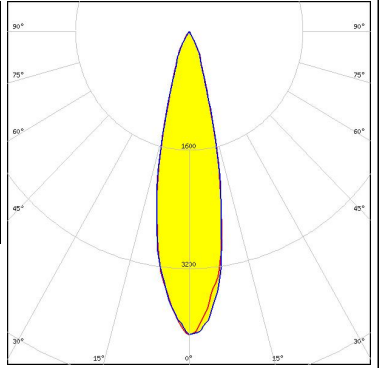
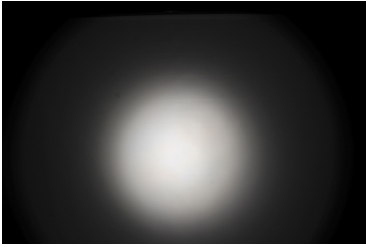
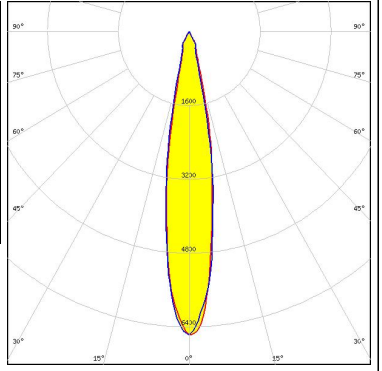

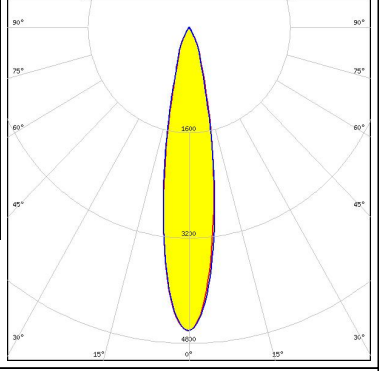

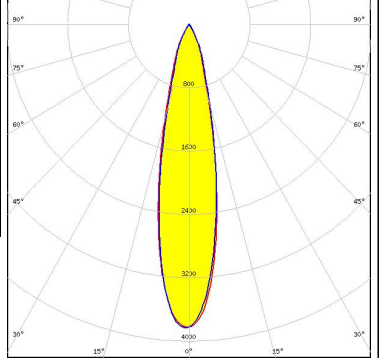
OPTICAL RESULTS (MEASURED):

<p>LUMILEDS</p> <p>LED LUXEON K16 FWHM / FWTM 20.0° / 40.0° Efficiency 77 % Peak intensity 0.5 cd/lm LEDs/each optic 1 Light colour White Required components: C12924_LENA-STD-BASE-LUXEON-K</p>		
<p>LUMINUS</p> <p>LED CDM-14 (Dim-To-Warm) FWHM / FWTM 22.0° / 40.0° Efficiency 87 % Peak intensity 4.9 cd/lm LEDs/each optic 1 Light colour White Required components: C13868_LENA-STD-BASE-VERO13-18 Bender Wirth: 491 Typ L2</p>		
<p>LUMINUS</p> <p>LED CDM-14 (Dim-To-Warm) FWHM / FWTM 23.0° / 49.0° Efficiency 82 % Peak intensity 3.7 cd/lm LEDs/each optic 1 Light colour White Required components: C13868_LENA-STD-BASE-VERO13-18 C11996_LENA-LENS Bender Wirth: 491 Typ L2</p>		
<p>LUMINUS</p> <p>LED CDM-18 (Dim-To-Warm) FWHM / FWTM 26.0° / 53.0° Efficiency 82 % Peak intensity 3 cd/lm LEDs/each optic 1 Light colour White Required components: C13868_LENA-STD-BASE-VERO13-18 C11996_LENA-LENS Bender Wirth: 491 Typ L2</p>		

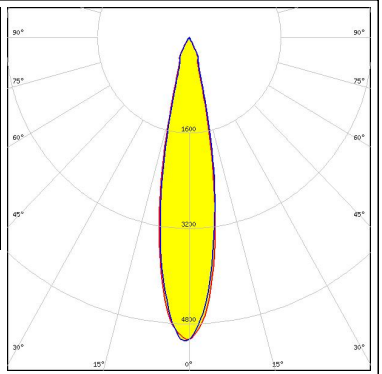

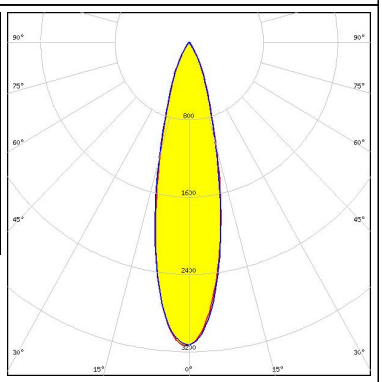

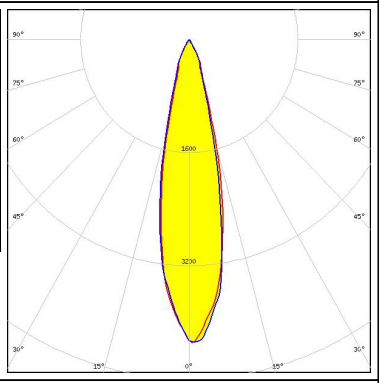

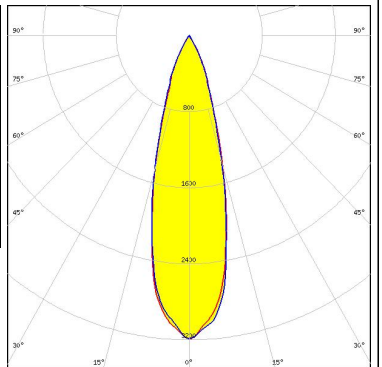
OPTICAL RESULTS (MEASURED):

<p>LUMINUS</p> <p>LED CDM-18 (Dim-To-Warm)</p> <p>FWHM / FWTM 25.0° / 47.0°</p> <p>Efficiency 87 %</p> <p>Peak intensity 4.1 cd/m</p> <p>LEDs/each optic 1</p> <p>Light colour White</p> <p>Required components: C13868_LENA-STD-BASE-VERO13-18 Bender Wirth: 491 Typ L2</p>		
<p>LUMINUS</p> <p>LED CDM-9 (Dim-To-Warm)</p> <p>FWHM / FWTM 18.0° / 33.0°</p> <p>Efficiency 88 %</p> <p>Peak intensity 6.6 cd/m</p> <p>LEDs/each optic 1</p> <p>Light colour White</p> <p>Required components: C13868_LENA-STD-BASE-VERO13-18 Bender Wirth: 490 Typ L1</p>		
<p>LUMINUS</p> <p>LED CDM-9 (Dim-To-Warm)</p> <p>FWHM / FWTM 20.0° / 43.0°</p> <p>Efficiency 82 %</p> <p>Peak intensity 4.6 cd/m</p> <p>LEDs/each optic 1</p> <p>Light colour White</p> <p>Required components: C13868_LENA-STD-BASE-VERO13-18 C11996_LENA-LENS Bender Wirth: 490 Typ L1</p>		
<p>LUMINUS</p> <p>LED CTM-14 (Tunable White)</p> <p>FWHM / FWTM 22.0° / 48.0°</p> <p>Efficiency 81 %</p> <p>Peak intensity 3.8 cd/m</p> <p>LEDs/each optic 1</p> <p>Light colour White</p> <p>Required components: C13867_LENA-STD-BASE-VERO29 C12606_LENINA-DL Bender Wirth: 442 Typ L3</p>		

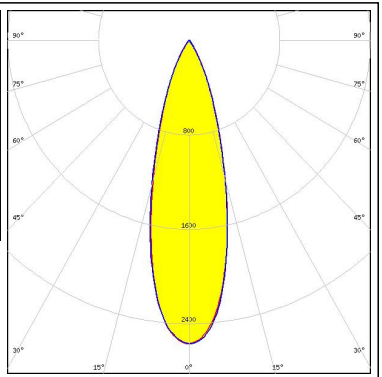
OPTICAL RESULTS (MEASURED):

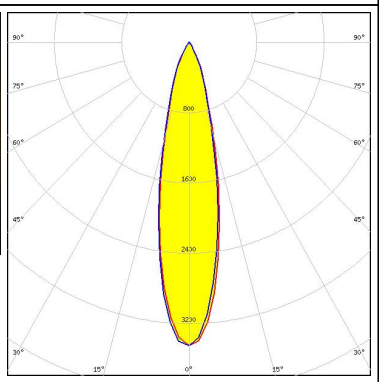
<p>LUMINUS</p> <p>LED CTM-14 (Tunable White) FWHM / FWTM 21.0° / 39.0° Efficiency 87 % Peak intensity 5.1 cd/m LEDs/each optic 1 Light colour White</p> <p>Required components: C13867_LENA-STD-BASE-VERO29 Bender Wirth: 442 Typ L3</p>		
<p>LUMINUS</p> <p>LED CTM-18 (Tunable White) FWHM / FWTM 25.0° / 53.0° Efficiency 82 % Peak intensity 3.1 cd/m LEDs/each optic 1 Light colour White</p> <p>Required components: C13867_LENA-STD-BASE-VERO29 C11996_LENA-LENS Bender Wirth: 442 Typ L3</p>		
<p>LUMINUS</p> <p>LED CTM-18 (Tunable White) FWHM / FWTM 24.0° / 45.0° Efficiency 87 % Peak intensity 4.3 cd/m LEDs/each optic 1 Light colour White</p> <p>Required components: C13867_LENA-STD-BASE-VERO29 Bender Wirth: 442 Typ L3</p>		
<p>LUMINUS</p> <p>LED CTM-22 (Tunable White) FWHM / FWTM 28.0° / 54.0° Efficiency 87 % Peak intensity 3.2 cd/m LEDs/each optic 1 Light colour White</p> <p>Required components: C13867_LENA-STD-BASE-VERO29 Bender Wirth: 494 Typ L3</p>		

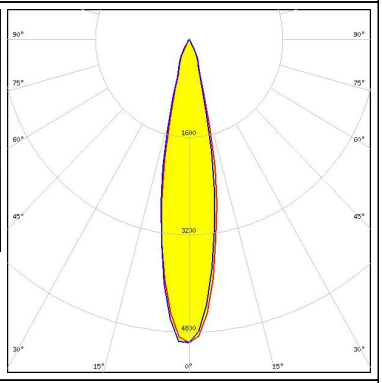
OPTICAL RESULTS (MEASURED):

<p>LUMINUS</p> <p>LED CTM-22 (Tunable White)</p> <p>FWHM / FWTM 29.0° / 56.0°</p> <p>Efficiency 82 %</p> <p>Peak intensity 2.6 cd/lm</p> <p>LEDs/each optic 1</p> <p>Light colour White</p> <p>Required components: C13867_LENA-STD-BASE-VERO29 C11996_LENA-LENS Bender Wirth: 494 Typ L3</p>		
<p>LUMINUS</p> <p>LED CxM-14 (19x19)</p> <p>FWHM / FWTM 24.0° / 51.0°</p> <p>Efficiency 79 %</p> <p>Peak intensity 3.5 cd/lm</p> <p>LEDs/each optic 1</p> <p>Light colour White</p> <p>Required components: C12691_LENA-STD-BASE-CLL030 C11996_LENA-LENS</p>		
<p>LUMINUS</p> <p>LED CxM-14 (19x19)</p> <p>FWHM / FWTM 22.0° / 40.0°</p> <p>Efficiency 84 %</p> <p>Peak intensity 5 cd/lm</p> <p>LEDs/each optic 1</p> <p>Light colour White</p> <p>Required components: C12691_LENA-STD-BASE-CLL030</p>		
<p>LUMINUS</p> <p>LED CxM-22 (28x28)</p> <p>FWHM / FWTM 27.0° / 56.0°</p> <p>Efficiency 84 %</p> <p>Peak intensity 3.5 cd/lm</p> <p>LEDs/each optic 1</p> <p>Light colour White</p> <p>Required components: C12692_LENA-STD-BASE-CLL040</p>		

OPTICAL RESULTS (MEASURED):



LED CxM-22 (28x28)
 FWHM / FWTM 29.0° / 58.0°
 Efficiency 79 %
 Peak intensity 2.7 cd/lm
 LEDs/each optic 1
 Light colour White

Required components:

C12692_LENA-STD-BASE-CLL040
 C11996_LENA-LENS

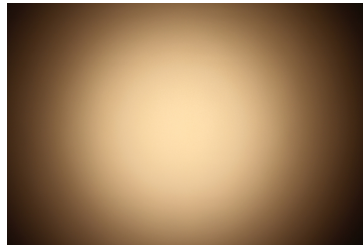

LED COB J-Type
 FWHM / FWTM 24.0° / 52.0°
 Efficiency 80 %
 Peak intensity 3.3 cd/lm
 LEDs/each optic 1
 Light colour White

Required components:

C13868_LENA-STD-BASE-VERO13-18
 C11996_LENA-LENS
 Bender Wirth: 463 Typ L2

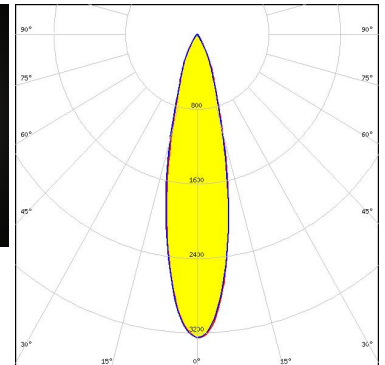
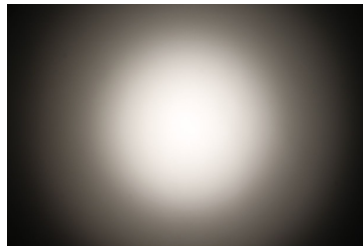

LED COB L-Type (LES 11)
 FWHM / FWTM 21.0° / 47.0°
 Efficiency 80 %
 Peak intensity 4 cd/lm
 LEDs/each optic 1
 Light colour White

Required components:

C13868_LENA-STD-BASE-VERO13-18
 C11996_LENA-LENS
 Bender Wirth: 438 Typ L1

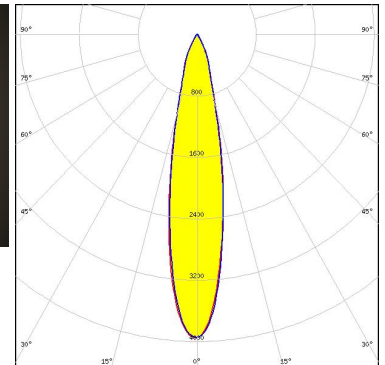
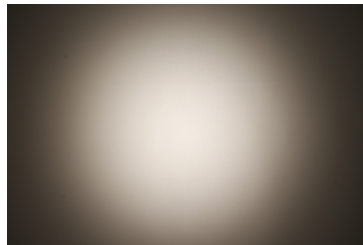



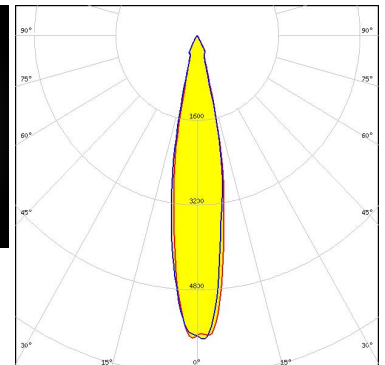

LED COB L-Type (LES 11)
 FWHM / FWTM 20.0° / 34.0°
 Efficiency 85 %
 Peak intensity 5.7 cd/lm
 LEDs/each optic 1
 Light colour White

Required components:



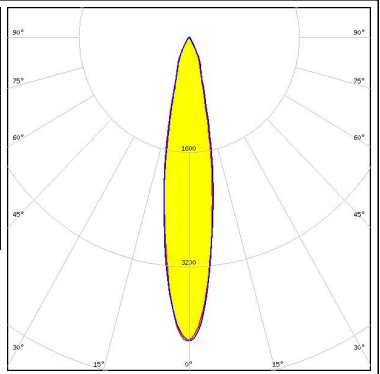

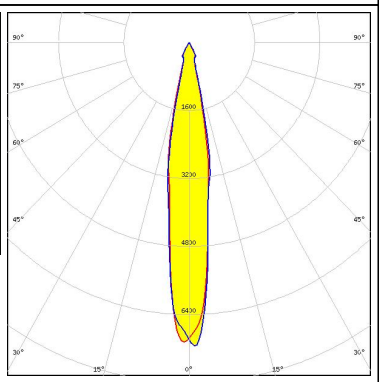
C13868_LENA-STD-BASE-VERO13-18
 Bender Wirth: 438 Typ L1

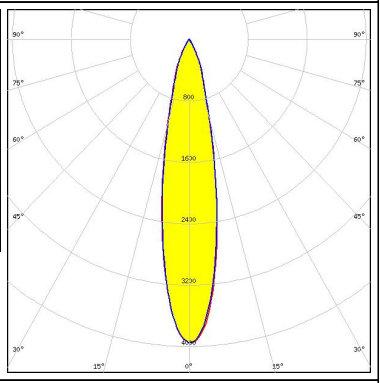
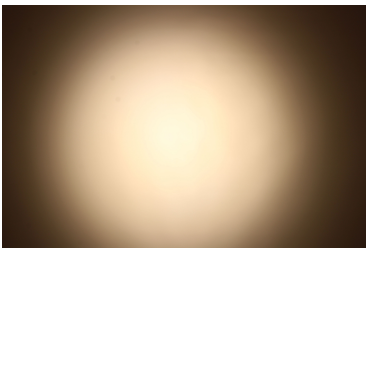
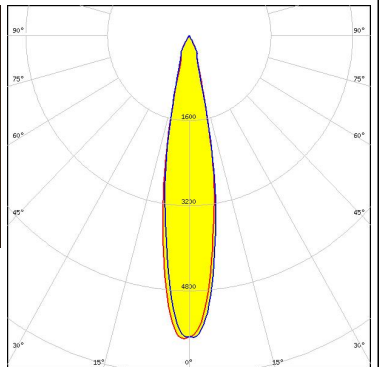

OPTICAL RESULTS (MEASURED):

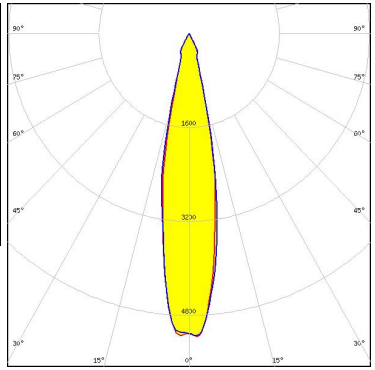
<p>NICHIA</p> <p>LED COB L-Type (LES 9)</p> <p>FWHM / FWTM 19.0° / 45.0°</p> <p>Efficiency 81 %</p> <p>Peak intensity 4.2 cd/lm</p> <p>LEDs/each optic 1</p> <p>Light colour White</p> <p>Required components: C13868_LENA-STD-BASE-VERO13-18 C11996_LENA-LENS Bender Wirth: 438 Typ L1</p>		
<p>NICHIA</p> <p>LED COB L-Type (LES 9)</p> <p>FWHM / FWTM 16.0° / 30.0°</p> <p>Efficiency 86 %</p> <p>Peak intensity 7.2 cd/lm</p> <p>LEDs/each optic 1</p> <p>Light colour White</p> <p>Required components: C13868_LENA-STD-BASE-VERO13-18 Bender Wirth: 438 Typ L1</p>		
<p>NICHIA</p> <p>LED NVCWJ024Z-V1MT: COB J-Type Tunable White</p> <p>FWHM / FWTM 21.0° / 48.0°</p> <p>Efficiency 82 %</p> <p>Peak intensity 4 cd/lm</p> <p>LEDs/each optic 1</p> <p>Light colour White</p> <p>Required components: C13868_LENA-STD-BASE-VERO13-18 C11996_LENA-LENS Bender Wirth: 498 Typ L2</p>		
<p>NICHIA</p> <p>LED NVCWJ024Z-V1MT: COB J-Type Tunable White</p> <p>FWHM / FWTM 20.0° / 36.0°</p> <p>Efficiency 87 %</p> <p>Peak intensity 5.7 cd/lm</p> <p>LEDs/each optic 1</p> <p>Light colour White</p> <p>Required components: C13868_LENA-STD-BASE-VERO13-18 Bender Wirth: 498 Typ L2</p>		

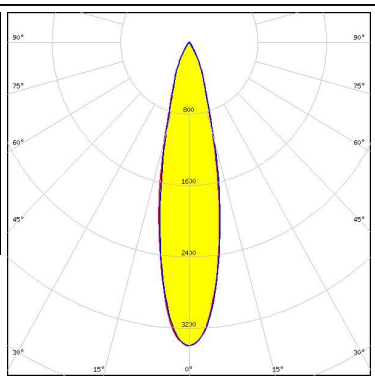
OPTICAL RESULTS (MEASURED):

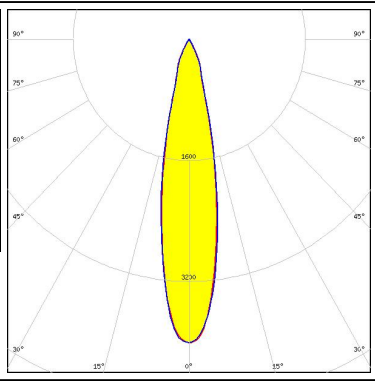
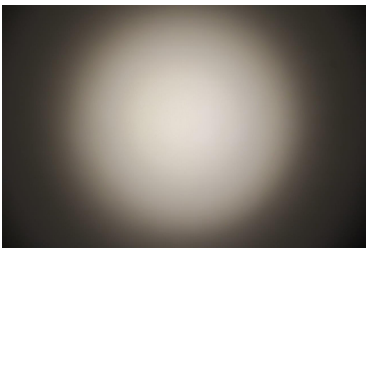
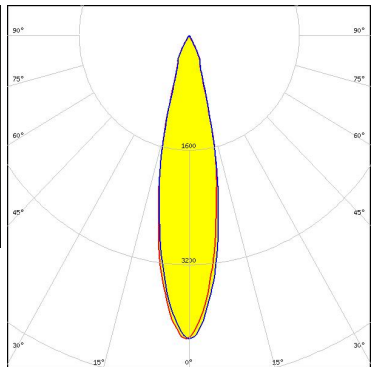
<p>OSRAM Opto Semiconductors</p> <p>LED Soleriq S13 FWHM / FWTM 21.0° / 36.0° Efficiency 83 % Peak intensity 5.2 cd/m LEDs/each optic 1 Light colour White</p> <p>Required components: C13868_LENA-STD-BASE-VERO13-18 Bender Wirth: 437 Typ L1</p>		
<p>OSRAM Opto Semiconductors</p> <p>LED Soleriq S13 FWHM / FWTM 23.0° / 50.0° Efficiency 81 % Peak intensity 3.4 cd/m LEDs/each optic 1 Light colour White</p> <p>Required components: C13868_LENA-STD-BASE-VERO13-18 C11996_LENA-LENS</p>		
<p>OSRAM Opto Semiconductors</p> <p>LED Soleriq S13 FWHM / FWTM 22.0° / 46.0° Efficiency 78 % Peak intensity 4 cd/m LEDs/each optic 1 Light colour White</p> <p>Required components: C13868_LENA-STD-BASE-VERO13-18 C11996_LENA-LENS Bender Wirth: 437 Typ L1</p>		
<p>OSRAM Opto Semiconductors</p> <p>LED Soleriq S19 FWHM / FWTM 23.0° / 45.0° Efficiency 83 % Peak intensity 4.2 cd/m LEDs/each optic 1 Light colour White</p> <p>Required components: C13867_LENA-STD-BASE-VERO29 Bender Wirth: 462 Typ L3</p>		

OPTICAL RESULTS (MEASURED):

OSRAM

Opto Semiconductors

LED Soleriq S19
FWHM / FWTM 24.0° / 51.0°
Efficiency 78 %
Peak intensity 3.3 cd/lm
LEDs/each optic 1
Light colour White

Required components:

C13867_LENA-STD-BASE-VERO29
C11996_LENA-LENS
Bender Wirth: 462 Typ L3

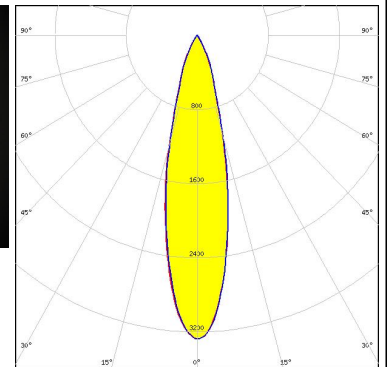
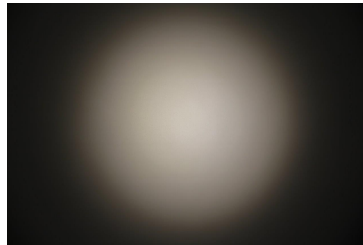

PHILIPS

LED Fortimo SLM L13 CoB
FWHM / FWTM 18.0° / 34.0°
Efficiency 89 %
Peak intensity 6.5 cd/lm
LEDs/each optic 1
Light colour White

Required components:

C12292_LENA-STD-BASE-MEZ

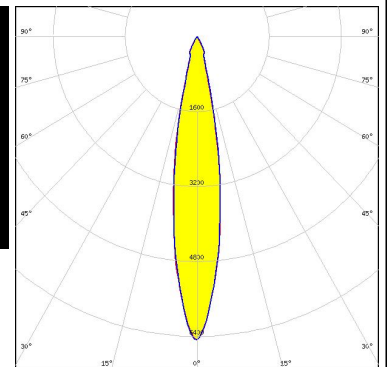

PHILIPS

LED Fortimo SLM L13 CoB
FWHM / FWTM 19.0° / 40.0°
Efficiency 84 %
Peak intensity 5 cd/lm
LEDs/each optic 1
Light colour White

Required components:

C12292_LENA-STD-BASE-MEZ
C11996_LENA-LENS

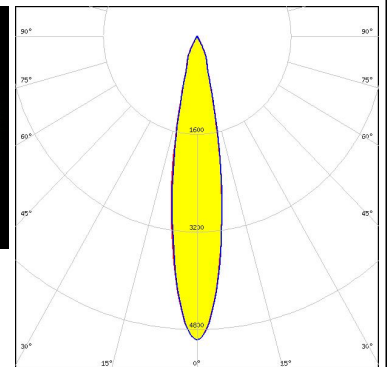
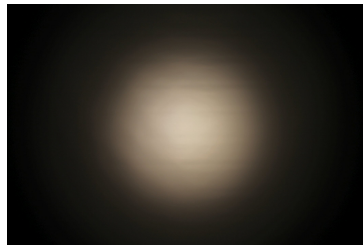

PHILIPS

LED Fortimo SLM L15 CoB
FWHM / FWTM 20.0° / 38.0°
Efficiency 90 %
Peak intensity 5.7 cd/lm
LEDs/each optic 1
Light colour White

Required components:

C12292_LENA-STD-BASE-MEZ

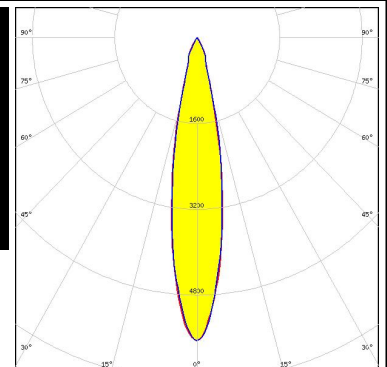
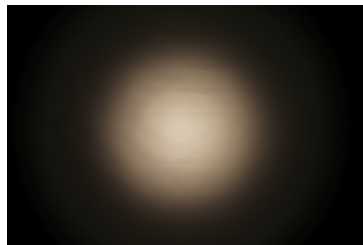

OPTICAL RESULTS (MEASURED):

PHILIPS

LED Fortimo SLM L15 CoB
 FWHM / FWTM 21.0° / 46.0°
 Efficiency 84 %
 Peak intensity 4.3 cd/m
 LEDs/each optic 1
 Light colour White
 Required components:
 C12292_LENA-STD-BASE-MEZ
 C11996_LENA-LENS

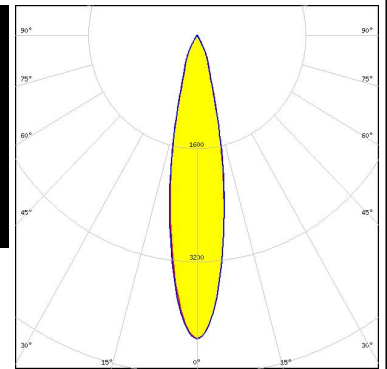

PHILIPS

LED Fortimo SLM L19 CoB
 FWHM / FWTM 22.0° / 48.0°
 Efficiency 90 %
 Peak intensity 4.6 cd/m
 LEDs/each optic 1
 Light colour White
 Required components:
 C12692_LENA-STD-BASE-CLL040

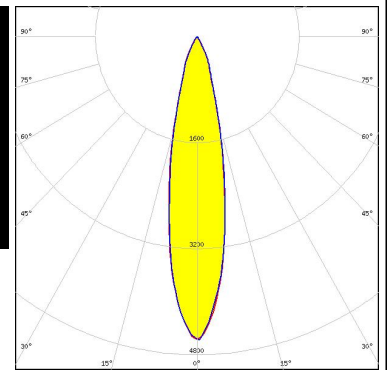

PHILIPS

LED Fortimo SLM L19 CoB
 FWHM / FWTM 24.0° / 51.0°
 Efficiency 84 %
 Peak intensity 3.5 cd/m
 LEDs/each optic 1
 Light colour White
 Required components:
 C12692_LENA-STD-BASE-CLL040
 C11996_LENA-LENS

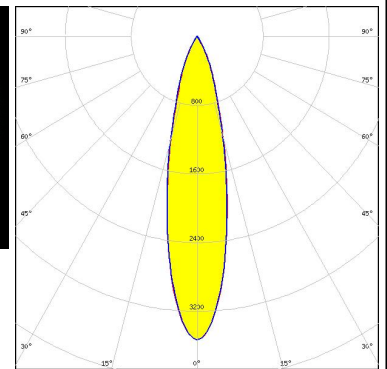
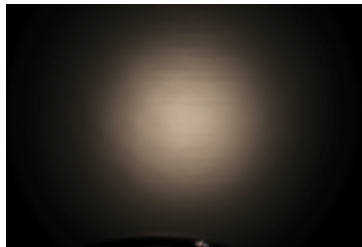

PHILIPS

LED Fortimo SLM L23 CoB
 FWHM / FWTM 27.0° / 54.0°
 Efficiency 83 %
 Peak intensity 2.9 cd/m
 LEDs/each optic 1
 Light colour White
 Required components:
 C12692_LENA-STD-BASE-CLL040
 C11996_LENA-LENS

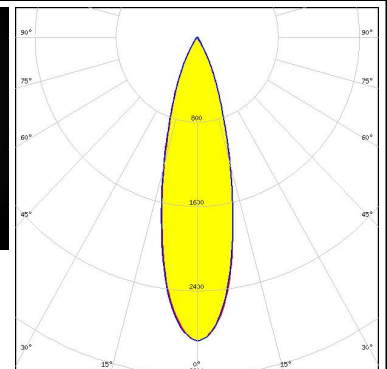
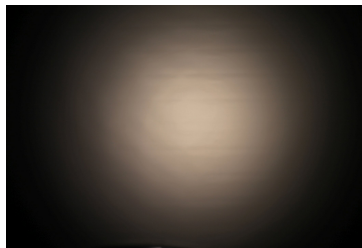

OPTICAL RESULTS (MEASURED):

PHILIPS

LED Fortimo SLM L23 CoB
 FWHM / FWTM 26.0° / 52.0°
 Efficiency 89 %
 Peak intensity 3.6 cd/lm
 LEDs/each optic 1
 Light colour White
 Required components:
 C12692_LENA-STD-BASE-CLL040

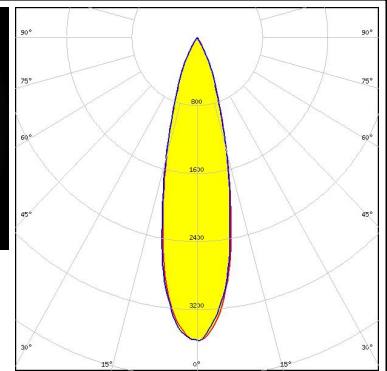
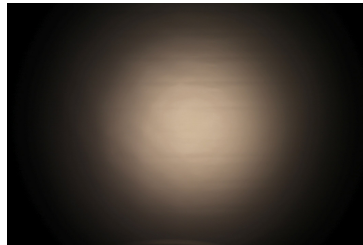

SAMSUNG

LED LC016D / LC019D / LC026D / LC033D
 FWHM / FWTM 23.0° / 51.0°
 Efficiency 81 %
 Peak intensity 3.4 cd/lm
 LEDs/each optic 1
 Light colour White
 Required components:
 C12691_LENA-STD-BASE-CLL030
 C11996_LENA-LENS

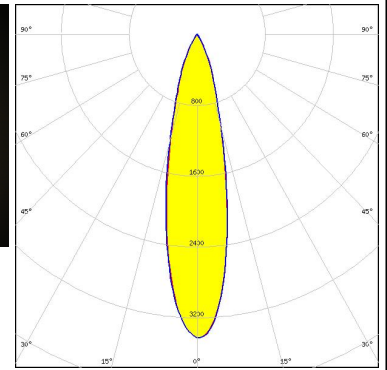
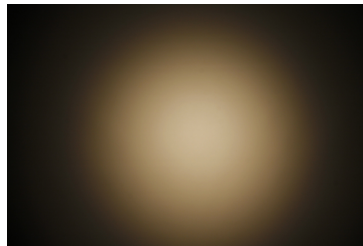

SAMSUNG

LED LC016D / LC019D / LC026D / LC033D
 FWHM / FWTM 22.0° / 44.0°
 Efficiency 86 %
 Peak intensity 4.6 cd/lm
 LEDs/each optic 1
 Light colour White
 Required components:
 C12691_LENA-STD-BASE-CLL030

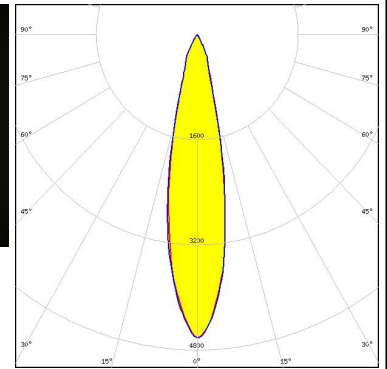
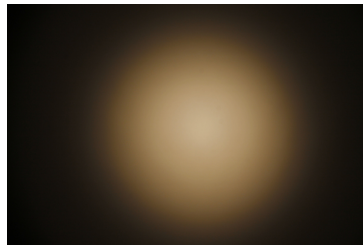

SAMSUNG

LED LC040D / LC060D / LC080D
 FWHM / FWTM 30.0° / 57.0°
 Efficiency 81 %
 Peak intensity 2.4 cd/lm
 LEDs/each optic 1
 Light colour White
 Required components:
 C12692_LENA-STD-BASE-CLL040
 C11996_LENA-LENS

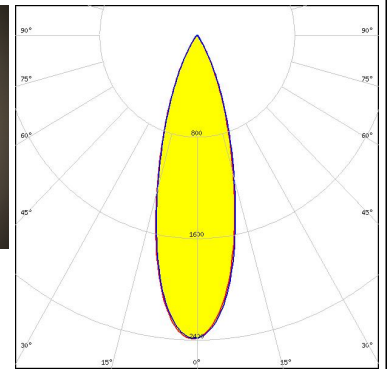
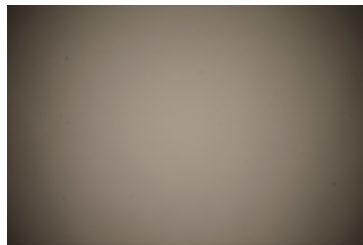

OPTICAL RESULTS (MEASURED):

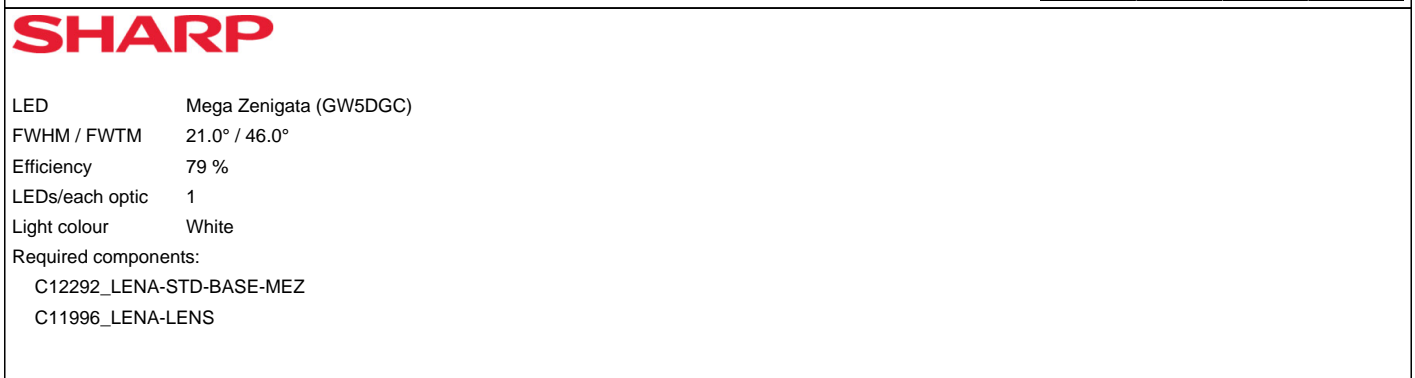

OPTICAL RESULTS (MEASURED):

TRIDONIC

LED SLE G7 LES15
 FWHM / FWTM 22.0° / 43.0°
 Efficiency 88 %
 Peak intensity 4.9 cd/m
 LEDs/each optic 1
 Light colour White
 Required components:
 C12691_LENA-STD-BASE-CLL030

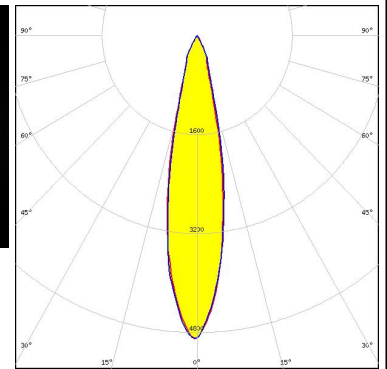
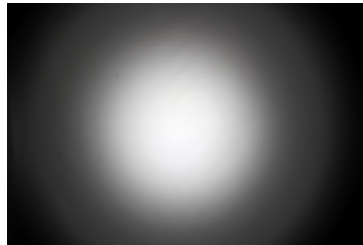

TRIDONIC

LED SLE G7 LES17 H
 FWHM / FWTM 23.0° / 46.0°
 Efficiency 86 %
 Peak intensity 4.4 cd/m
 LEDs/each optic 1
 Light colour White
 Required components:
 C14547_LENA-ADAPTER-B

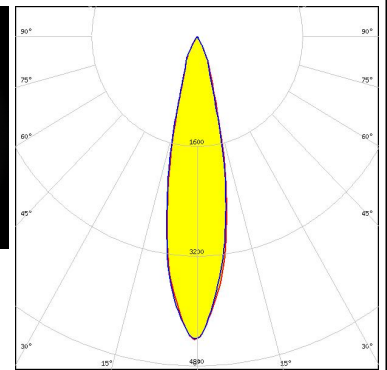
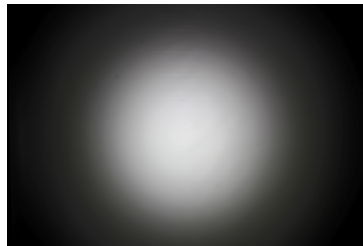

TRIDONIC

LED SLE G7 LES21 H
 FWHM / FWTM 27.0° / 52.0°
 Efficiency 86 %
 Peak intensity 3.4 cd/m
 LEDs/each optic 1
 Light colour White
 Required components:
 C14547_LENA-ADAPTER-B

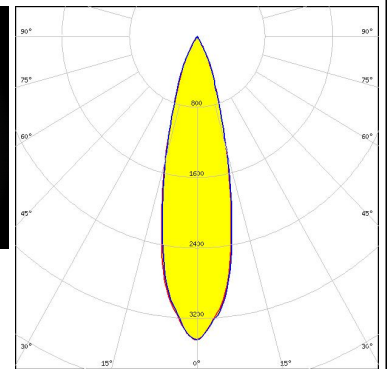
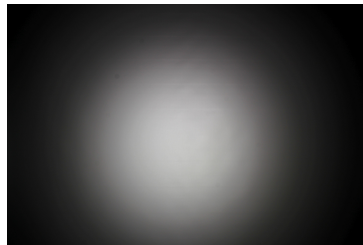





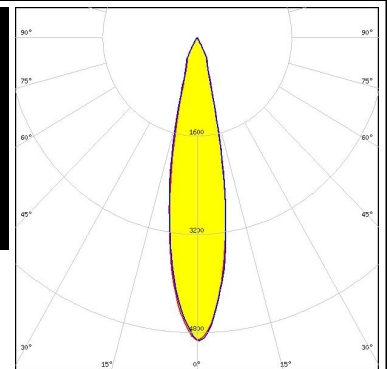
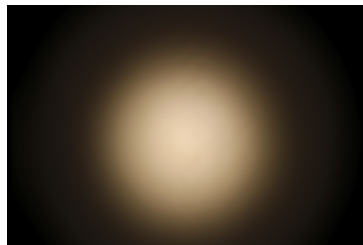

XICATO

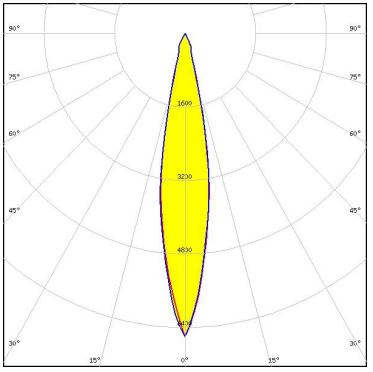

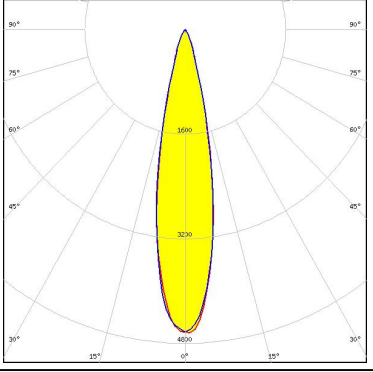

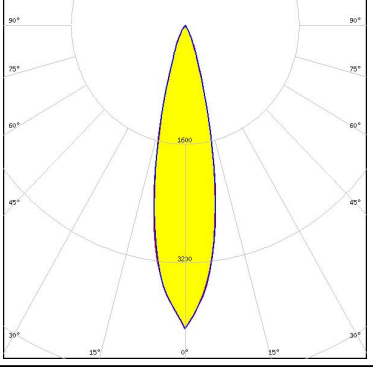

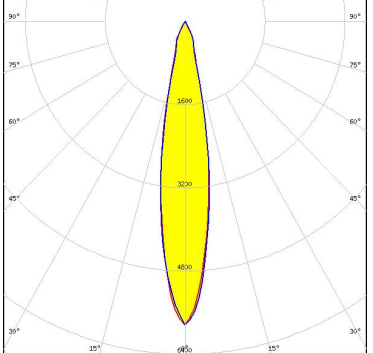
LED XOB 14.5 mm
 FWHM / FWTM 22.0° / 42.0°
 Efficiency 88 %
 Peak intensity 4.9 cd/m
 LEDs/each optic 1
 Light colour White
 Required components:
 C12691_LENA-STD-BASE-CLL030

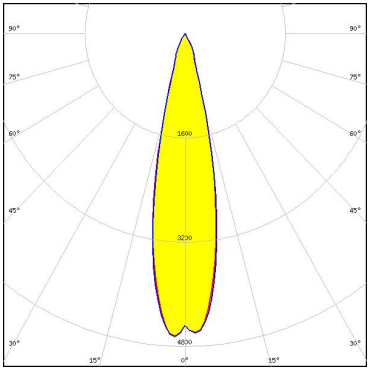

OPTICAL RESULTS (SIMULATED):

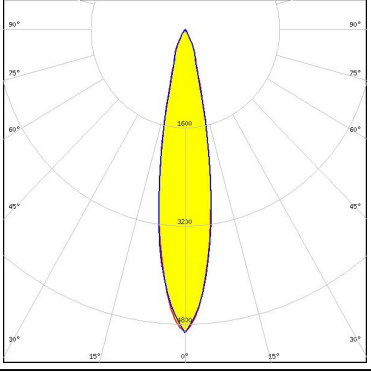
<p></p> <p>LED V10 Gen7 FWHM / FWTM 19.0° / 33.0° Efficiency 88 % Peak intensity 6.6 cd/lm LEDs/each optic 1 Light colour White Required components: C13868_LENA-STD-BASE-VERO13-18 Bender Wirth: 486 Typ L1</p>	
<p></p> <p>LED V10 Gen7 FWHM / FWTM 22.0° / 39.0° Efficiency 81 % Peak intensity 4.7 cd/lm LEDs/each optic 1 Light colour White Required components: C13868_LENA-STD-BASE-VERO13-18 C11996_LENA-LENS Bender Wirth: 486 Typ L1</p>	
<p></p> <p>LED V13 Gen7 FWHM / FWTM 24.0° / 44.0° Efficiency 82 % Peak intensity 4.1 cd/lm LEDs/each optic 1 Light colour White Required components: C13868_LENA-STD-BASE-VERO13-18 C11996_LENA-LENS</p>	
<p></p> <p>LED V13 Gen7 FWHM / FWTM 18.0° / 36.0° Efficiency 87 % Peak intensity 5.8 cd/lm LEDs/each optic 1 Light colour White Required components: IDEAL: 50-2103CT + 50-2100LN</p>	

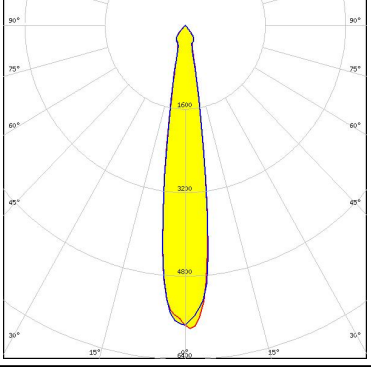
OPTICAL RESULTS (SIMULATED):

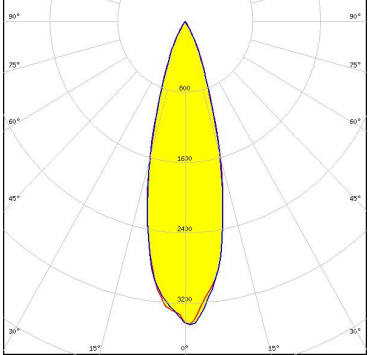
<p></p> <p>LED V13 Gen7 FWHM / FWTM 23.0° / 40.0° Efficiency 88 % Peak intensity 4.7 cd/lm LEDs/each optic 1 Light colour White Required components: C13868_LENA-STD-BASE-VERO13-18 Bender Wirth: 477 Typ L1</p>	
<p></p> <p>LED V13 Gen7 FWHM / FWTM 20.0° / 42.0° Efficiency 84 % Peak intensity 4.9 cd/lm LEDs/each optic 1 Light colour White Required components: C11996_LENA-LENS IDEAL: 50-2103CT + 50-2100LN</p>	
<p></p> <p>LED V22 Gen7 FWHM / FWTM 28.0° / 52.0° Efficiency 94 % Peak intensity 5.8 cd/lm LEDs/each optic 1 Light colour White Required components: C13867_LENA-STD-BASE-VERO29 Bender Wirth: 431 Typ L3</p>	
<p></p> <p>LED V22 Gen7 FWHM / FWTM 28.0° / 52.0° Efficiency 90 % Peak intensity 3.5 cd/lm LEDs/each optic 1 Light colour White Required components: C13867_LENA-STD-BASE-VERO29 C11996_LENA-LENS Bender Wirth: 431 Typ L3</p>	

OPTICAL RESULTS (SIMULATED):



LED CXA/B 30xx
 FWHM / FWTM 20.0° / 46.0°
 Efficiency 86 %
 Peak intensity 4.8 cd/lm
 LEDs/each optic 1
 Light colour White
 Required components:
 IDEAL: 50-2234C + 50-2100LN

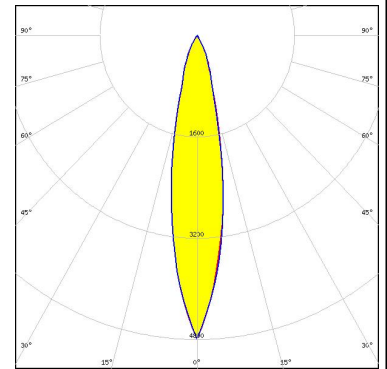

LED CXA/B 30xx
 FWHM / FWTM 24.0° / 50.0°
 Efficiency 80 %
 Peak intensity 3.6 cd/lm
 LEDs/each optic 1
 Light colour White
 Required components:
 C11996_LENA-LENS
 IDEAL: 50-2234C + 50-2100LN

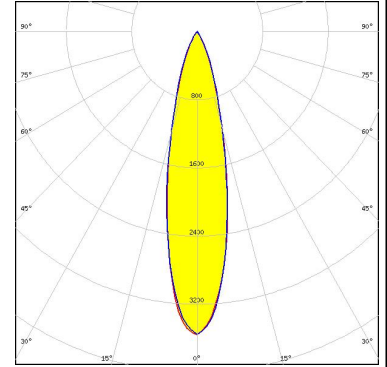

LED CxM-14 (19x19)
 FWHM / FWTM 22.0° / 39.0°
 Efficiency 83 %
 Peak intensity 4.7 cd/lm
 LEDs/each optic 1
 Light colour White
 Required components:
 C13868_LENA-STD-BASE-VERO13-18
 Bender Wirth: 433 Typ L1



LED CxM-14 (19x19)
 FWHM / FWTM 23.0° / 50.0°
 Efficiency 78 %
 Peak intensity 3.4 cd/lm
 LEDs/each optic 1
 Light colour White
 Required components:
 C13868_LENA-STD-BASE-VERO13-18
 C11996_LENA-LENS
 Bender Wirth: 433 Typ L1

OPTICAL RESULTS (SIMULATED):

LUMINUS

LED CxM-9 (13.5x13.5)
FWHM / FWTM 20.0° / 44.0°
Efficiency 78 %
Peak intensity 4.3 cd/lm
LEDs/each optic 1
Light colour White
Required components:
C13868_LENA-STD-BASE-VERO13-18
C11996_LENA-LENS
Bender Wirth: 434 Typ L1

LUMINUS

LED CxM-9 (13.5x13.5)
FWHM / FWTM 17.0° / 31.0°
Efficiency 83 %
Peak intensity 6.6 cd/lm
LEDs/each optic 1
Light colour White
Required components:
C13868_LENA-STD-BASE-VERO13-18
Bender Wirth: 434 Typ L1



SEOUL SEMICONDUCTOR

LED ZC12/18
FWHM / FWTM 23.0° / 50.0°
Efficiency 78 %
Peak intensity 3.4 cd/lm
LEDs/each optic 1
Light colour White
Required components:
C13868_LENA-STD-BASE-VERO13-18
C11996_LENA-LENS
Bender Wirth: 433 Typ L1



SEOUL SEMICONDUCTOR

LED ZC12/18
FWHM / FWTM 22.0° / 39.0°
Efficiency 83 %
Peak intensity 4.7 cd/lm
LEDs/each optic 1
Light colour White
Required components:
C13868_LENA-STD-BASE-VERO13-18
Bender Wirth: 433 Typ L1

OPTICAL RESULTS (SIMULATED):

	
SEOL SEMICONDUCTOR	
LED	ZC4/6
FWHM / FWTM	17.0° / 31.0°
Efficiency	83 %
Peak intensity	6.6 cd/lm
LEDs/each optic	1
Light colour	White
Required components:	
C13868_LENA-STD-BASE-VERO13-18	
Bender Wirth: 434 Typ L1	
<hr/>	
	
SEOL SEMICONDUCTOR	
LED	ZC4/6
FWHM / FWTM	20.0° / 44.0°
Efficiency	78 %
Peak intensity	4.3 cd/lm
LEDs/each optic	1
Light colour	White
Required components:	
C13868_LENA-STD-BASE-VERO13-18	
C11996_LENA-LENS	
Bender Wirth: 434 Typ L1	

GENERAL INFORMATION:

NOTE: The typical beam angle will be changed by different color, chip size and chip position tolerance. The typical total beam angle is the full angle measured where the luminous intensity is half of the peak value.

Due to use of high power COB's with this product, special attention to proper thermal design is highly recommended. LEDiL has no liability for direct, indirect or consecutive damages arising from the LEDiL products being used outside of the recommended temperature range.

MATERIALS:

As part of our continuous research and improvement processes, and to ensure the best possible quality and availability of our products, LEDiL reserves the right to change material grades without notice.

PRODUCT DATA USER AGREEMENT AND DISCLAIMER:

The measured data in the provided downloadable LEDiL Product Datasheets and Mechanical 2D-Drawings is rounded and provided as reference for planning. LEDiL Oy's optical specifications have been verified by conducting performance testing of the products in accordance with the company's quality system. The reported data are averaged results of multiple measurements with typical variation. LEDiL Oy reserves the right to without prior notification make changes and improvements to its products.

LEDiL Oy assumes neither warranty, nor guarantee nor any other liability of any kind for the contents and correctness of the provided data. The provided data has been generated with highest diligence but the provided data may in reality not represent the complete possible variation range of all intrinsic parameters. Therefore, in certain cases a deviation from the provided data could occur.

LEDiL Oy reserves the right to undertake technical changes of its products without further notification which could lead to changes in the provided data. LEDiL Oy assumes no liability of any kind for the possible deviation from any provided data or any other damage resulting from the usage of the provided data.

The user agrees to this disclaimer and user agreement with the download or usage of the provided files.

LEDiL Oy

Joensuunkatu 13
FI-24240 SALO
Finland

LEDiL Inc.

228 West Page Street
Suite D
Sycamore IL 60178
USA

Ledil Optics Technology (Shenzhen) Co., Ltd.

405 , Block B
Casic Motor Building
Shenzhen 518057
P.R.CHINA

Local sales and technical support

[www.ledil.com/
where_to_buy](http://www.ledil.com/where_to_buy)

Shipping locations

Salo, Finland
Hong Kong, China

Distribution Partners

[www.ledil.com/
where_to_buy](http://www.ledil.com/where_to_buy)