

# Quartz Crystal

SMD-version

model	KX – 9A
frequency	25,0 MHz
mode	fundamental
operating temperature	-20° ~ + 70°C
frequency tolerance at +25°C	± 30 ppm
temperature tolerance -20° ~ + 70°C	± 30 ppm
load capacitance $C_L$	16 pF
series resonance R1 max.	50 Ohm
aging at 25°C (first year) max.	± 2 ppm
shunt capacitance $C_O$ max.	5,0 pF
drive level in mW max.	0,05
contents of reel	1000 pcs.
part no.	12.89027

**Dimensions (mm):**

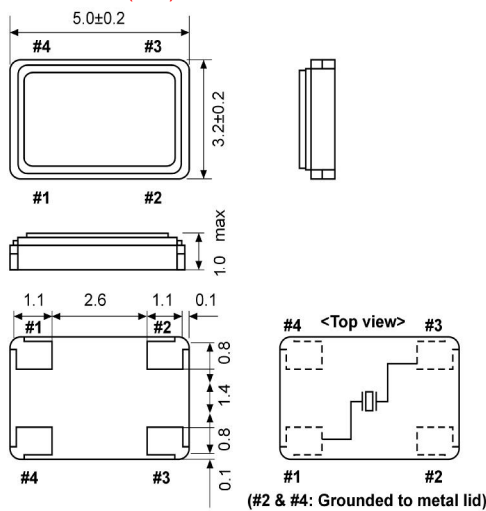

**Reflow soldering condition:**

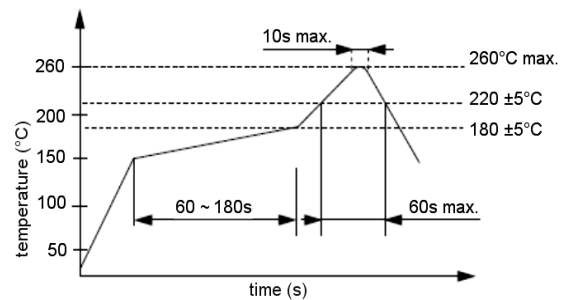

**Tape specification:**

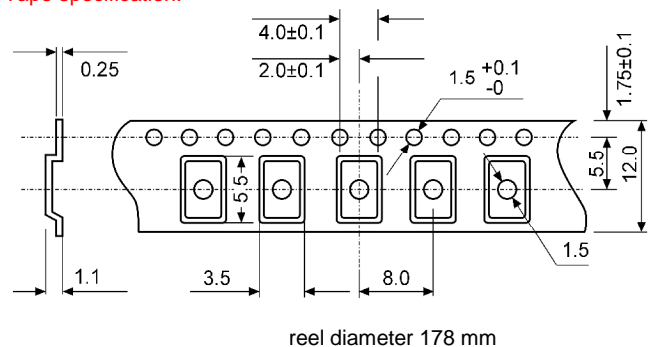

**Suggested soldering pad:**

