

## LENA-W

~45° wide beam

### SPECIFICATION:

Dimensions	Ø 111.0 mm
Height	80 mm
Fastening	socket
ROHS compliant	yes ⓘ

### MATERIALS:

Component	Type	Material	Colour	Finish	Coating
LENA-W	Reflector	PC	metal		lacquer



### ORDERING INFORMATION:

Component	Qty in box	MOQ	MPQ	Box weight (kg)
C11980_LENA-W » Box size: 400 x 280 x 380 mm	60	60	60	4.0

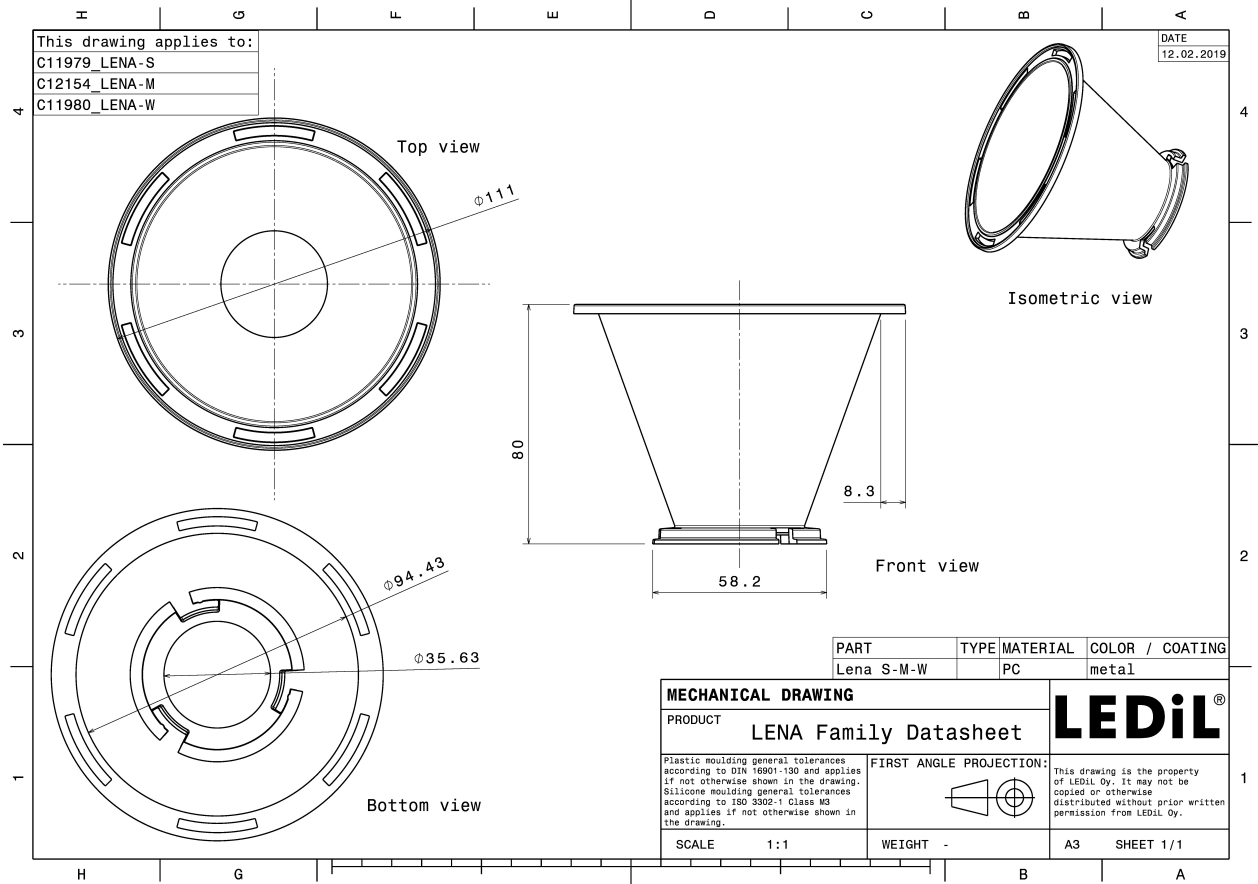

See also our general installation guide: [www.ledil.com/installation\\_guide](http://www.ledil.com/installation_guide)

### OPTICAL RESULTS (MEASURED):

bridgelux.

LED BXRA ES Rectangle  
FWHM / FWTM 46.0° / 64.0°  
Efficiency 74 %  
LEDs/each optic 1  
Light colour White  
Required components:  
C12153\_LENA-STD-BASE-BXRA  
C11996\_LENA-LENS

bridgelux.

LED BXRA RS  
FWHM / FWTM 51.0°  
Efficiency 81 %  
LEDs/each optic 1  
Light colour White  
Required components:  
C12229\_LENA-STD-BASE-RS

bridgelux.

LED BXRA RS  
FWHM / FWTM 51.0°  
Efficiency 76 %  
LEDs/each optic 1  
Light colour White  
Required components:  
C12229\_LENA-STD-BASE-RS  
C11996\_LENA-LENS

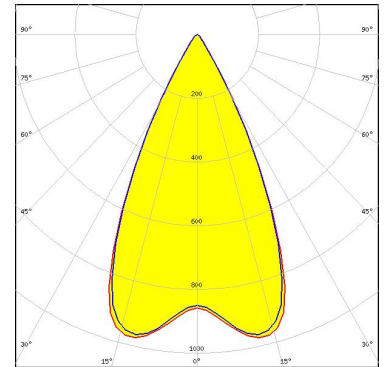





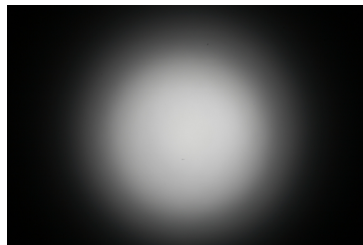

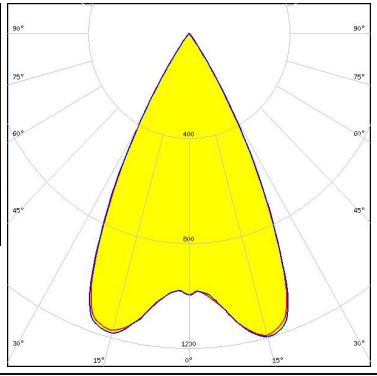

bridgelux.

LED V10 Gen6  
FWHM / FWTM 39.0° / 64.0°  
Efficiency 74 %  
Peak intensity 1.9 cd/lm  
LEDs/each optic 1  
Light colour White  
Required components:  
C13186\_LENA-STD-BASE-CXA15  
C11996\_LENA-LENS

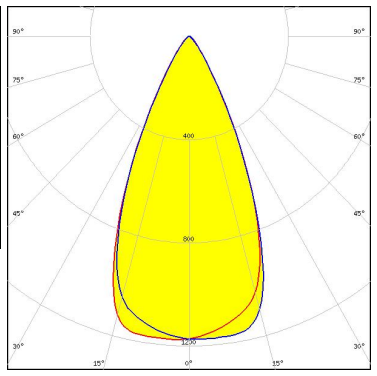

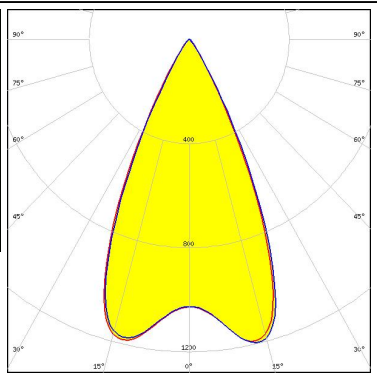
### OPTICAL RESULTS (MEASURED):

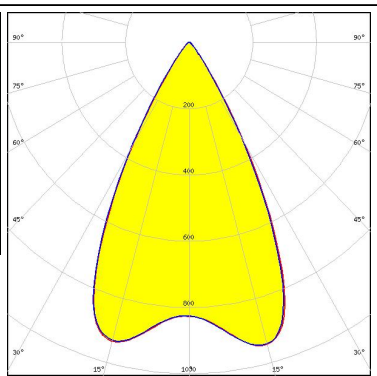
<p></p> <p>LED Vero SE 29            FWHM / FWTM 57.0° / 70.0°            Efficiency 86 %            Peak intensity 1.2 cd/lm            LEDs/each optic 1            Light colour White            Required components:            C15083_LENA-STD-BASE-VERO29</p>		
<p></p> <p>LED VERO13            FWHM / FWTM 48.0° / 71.0°            Efficiency 80 %            Peak intensity 1.2 cd/lm            LEDs/each optic 1            Light colour White            Required components:            C13868_LENA-STD-BASE-VERO13-18            C11996_LENA-LENS</p>		
<p></p> <p>LED VERO18            FWHM / FWTM 52.0° / 69.0°            Efficiency 80 %            Peak intensity 1.2 cd/lm            LEDs/each optic 1            Light colour White            Required components:            C13868_LENA-STD-BASE-VERO13-18            C11996_LENA-LENS</p>		
<p></p> <p>LED VERO29            FWHM / FWTM 57.0° / 75.0°            Efficiency 76 %            Peak intensity 1 cd/lm            LEDs/each optic 1            Light colour White            Required components:            C13867_LENA-STD-BASE-VERO29            C11996_LENA-LENS</p>		

#### OPTICAL RESULTS (MEASURED):

### CITIZEN

LED CL-L340  
 FWHM / FWTM 45.0° / 63.0°  
 Efficiency 75 %  
 Peak intensity 1.4 cd/m  
 LEDs/each optic 1  
 Light colour White  
 Required components:  
 C11995\_LENA-STD-BASE-CL340  
 C11996\_LENA-LENS

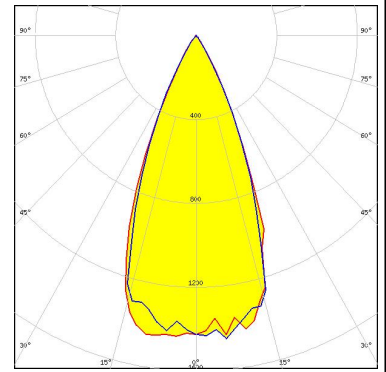

### CITIZEN

LED CLL02x/CLU02x (LES10)  
 FWHM / FWTM 45.0° / 64.0°  
 Efficiency 81 %  
 Peak intensity 1.5 cd/m  
 LEDs/each optic 1  
 Light colour White  
 Required components:  
 C13868\_LENA-STD-BASE-VERO13-18  
 C11996\_LENA-LENS  
 Bender Wirth: 434 Typ L1

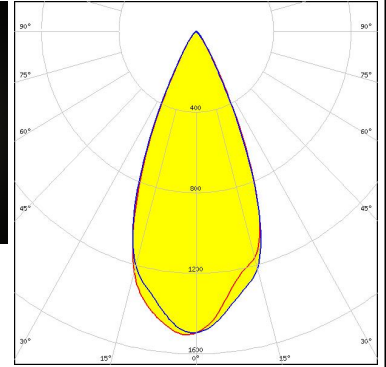
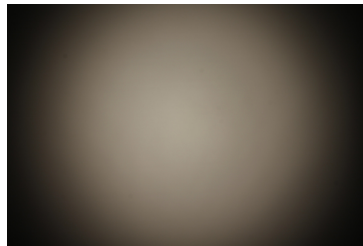

### CITIZEN

LED CLL03x/CLU03x  
 FWHM / FWTM 47.0° / 61.0°  
 Efficiency 85 %  
 Peak intensity 1.7 cd/m  
 LEDs/each optic 1  
 Light colour White  
 Required components:  
 C12691\_LENA-STD-BASE-CLL030

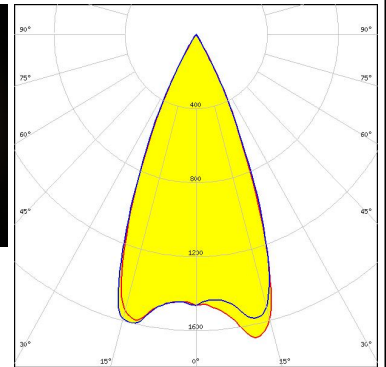
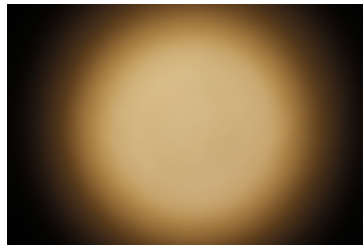

### CITIZEN

LED CLL03x/CLU03x  
 FWHM / FWTM 47.0° / 65.0°  
 Efficiency 80 %  
 Peak intensity 1.4 cd/m  
 LEDs/each optic 1  
 Light colour White  
 Required components:  
 C12691\_LENA-STD-BASE-CLL030  
 C11996\_LENA-LENS

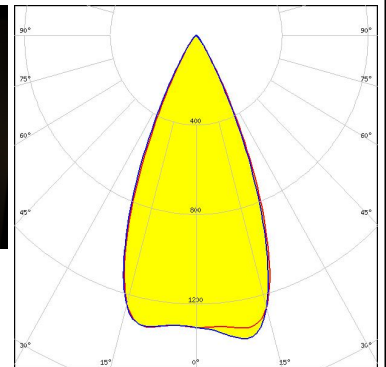

### OPTICAL RESULTS (MEASURED):

#### CITIZEN

LED CLL03x/CLU03x  
 FWHM / FWTM 45.0° / 66.0°  
 Efficiency 79 %  
 Peak intensity 1.4 cd/lm  
 LEDs/each optic 1  
 Light colour White  
 Required components:  
 C11996\_LENA-LENS  
 A.A.G. STUCCHI: 8101-G2 + S-8000-11

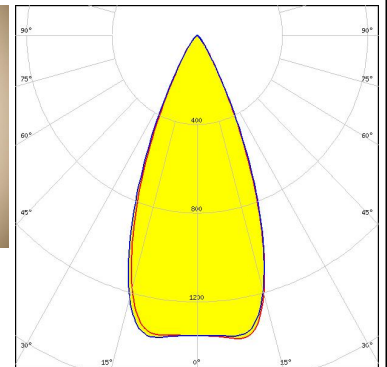
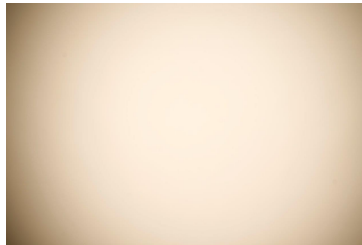

#### CITIZEN

LED CLL03x/CLU03x  
 FWHM / FWTM 47.0° / 67.0°  
 Efficiency 81 %  
 Peak intensity 1.3 cd/lm  
 LEDs/each optic 1  
 Light colour White  
 Required components:  
 C13868\_LENA-STD-BASE-VERO13-18  
 C11996\_LENA-LENS  
 Bender Wirth: 433 Typ L1

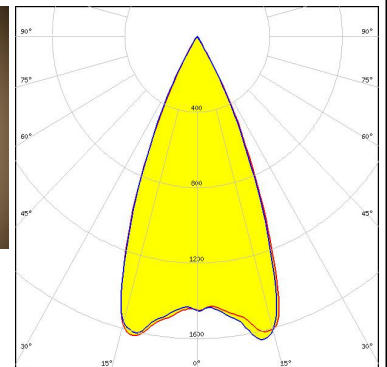
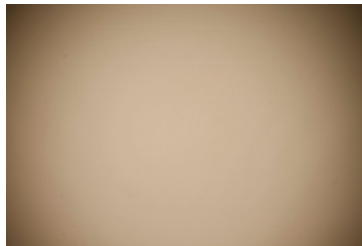

#### CITIZEN

LED CLL04x/CLU04x  
 FWHM / FWTM 49.0° / 72.0°  
 Efficiency 77 %  
 Peak intensity 1.2 cd/lm  
 LEDs/each optic 1  
 Light colour White  
 Required components:  
 C11996\_LENA-LENS  
 IDEAL: 50-2204CT + 50-2100LN

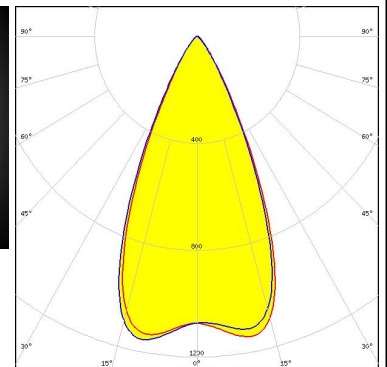
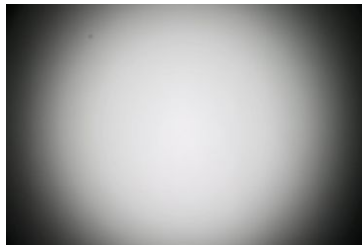

#### CITIZEN

LED CLL04x/CLU04x  
 FWHM / FWTM 46.0° / 64.0°  
 Efficiency 76 %  
 Peak intensity 1.1 cd/lm  
 LEDs/each optic 1  
 Light colour White  
 Required components:  
 C12692\_LENA-STD-BASE-CLL040  
 C11996\_LENA-LENS

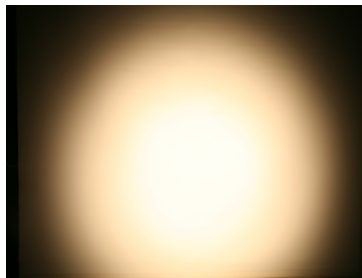

### OPTICAL RESULTS (MEASURED):

#### CITIZEN

LED CLL04x/CLU04x  
 FWHM / FWTM 52.0° / 66.0°  
 Efficiency 86 %  
 Peak intensity 1.4 cd/lm  
 LEDs/each optic 1  
 Light colour White  
 Required components:  
 C12692\_LENA-STD-BASE-CLL040

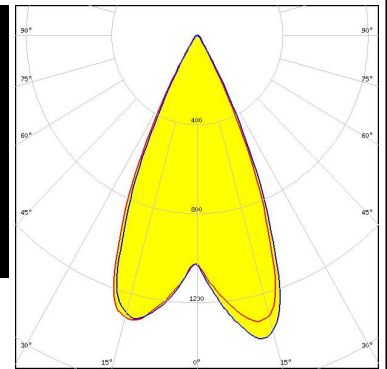

#### CITIZEN

LED CLL04x/CLU04x  
 FWHM / FWTM 50.0° / 65.0°  
 Efficiency 81 %  
 Peak intensity 1.4 cd/lm  
 LEDs/each optic 1  
 Light colour White  
 Required components:  
 IDEAL: 50-2204CT + 50-2100LN

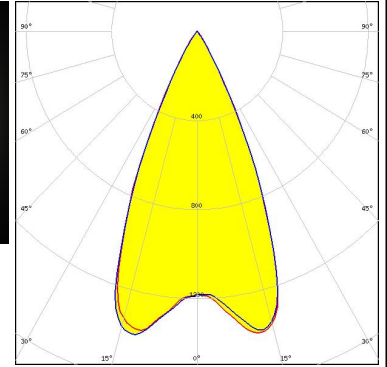

#### CITIZEN

LED CLL04x/CLU04x  
 FWHM / FWTM 50.0° / 78.0°  
 Efficiency 73 %  
 Peak intensity 1 cd/lm  
 LEDs/each optic 1  
 Light colour White  
 Required components:  
 C11996\_LENA-LENS  
 A.A.G. STUCCHI: 8102-G2 + S-8000-12

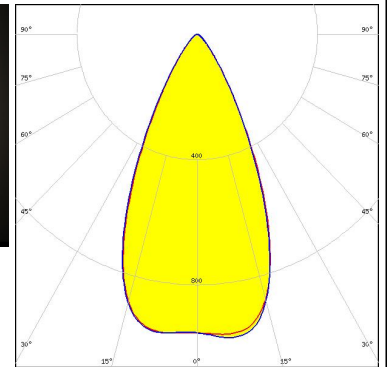

#### CITIZEN

LED CLU700/701/702/703  
 FWHM / FWTM 39.0° / 61.0°  
 Efficiency 81 %  
 Peak intensity 1.9 cd/lm  
 LEDs/each optic 1  
 Light colour White  
 Required components:  
 C13868\_LENA-STD-BASE-VERO13-18  
 C11996\_LENA-LENS  
 Bender Wirth: 434 Typ L1

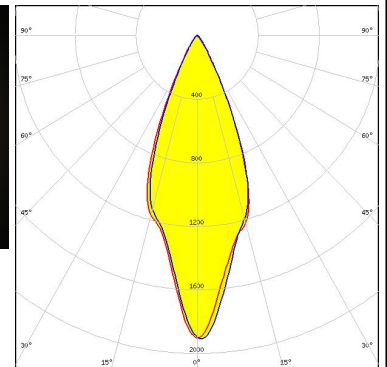
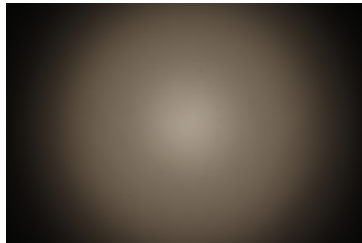

### OPTICAL RESULTS (MEASURED):

#### CITIZEN

LED CLU720/721/723  
 FWHM / FWTM 46.0° / 66.0°  
 Efficiency 76 %  
 Peak intensity 1.3 cd/m  
 LEDs/each optic 1  
 Light colour White  
 Required components:  
 C12691\_LENA-STD-BASE-CLL030  
 C11996\_LENA-LENS

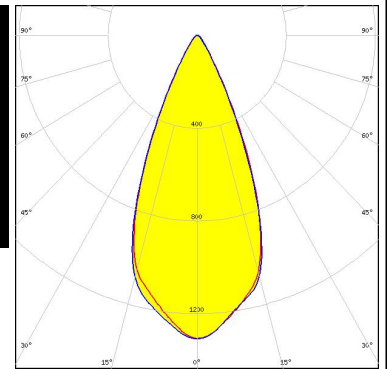
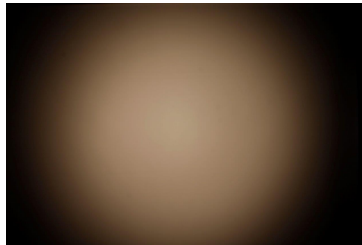

#### CITIZEN

LED CLU720/721/723  
 FWHM / FWTM 44.0° / 60.0°  
 Efficiency 81 %  
 Peak intensity 1.6 cd/m  
 LEDs/each optic 1  
 Light colour White  
 Required components:  
 C12691\_LENA-STD-BASE-CLL030

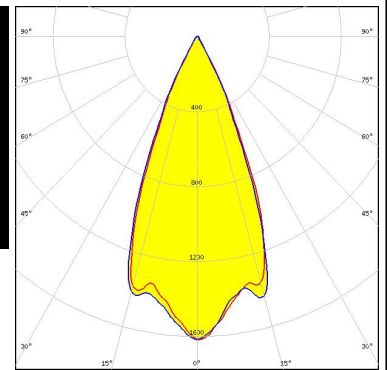
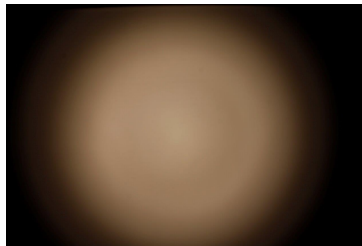

#### CREE LEDs

LED CMA1840  
 FWHM / FWTM 43.0° / 60.0°  
 Efficiency 86 %  
 Peak intensity 1.8 cd/m  
 LEDs/each optic 1  
 Light colour White  
 Required components:  
 C14146\_LENA-STD-BASE-CXA18

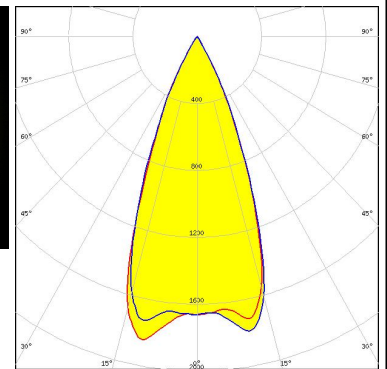
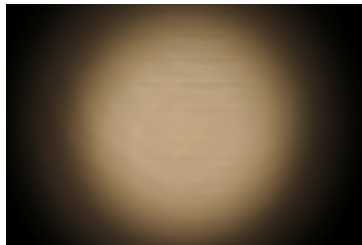

#### CREE LEDs

LED CMA2550  
 FWHM / FWTM 49.0° / 63.0°  
 Efficiency 86 %  
 Peak intensity 1.6 cd/m  
 LEDs/each optic 1  
 Light colour White  
 Required components:  
 C13324\_LENA-STD-BASE-CXA25

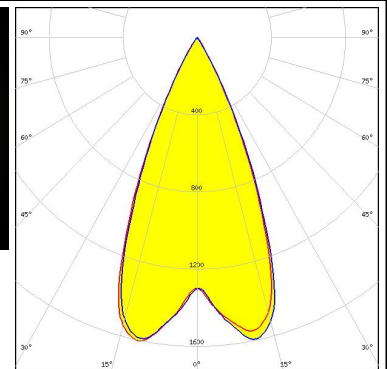
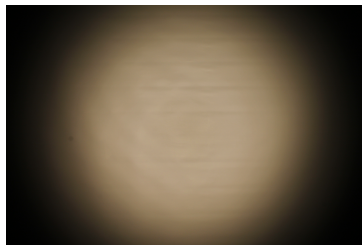



#### OPTICAL RESULTS (MEASURED):



LED CMT14xx  
 FWHM / FWTM 44.0° / 60.0°  
 Efficiency 85 %  
 Peak intensity 1.8 cd/m  
 LEDs/each optic 1  
 Light colour White

Required components:

C13868\_LENA-STD-BASE-VERO13-18  
 Bender Wirth: 434 Typ L1

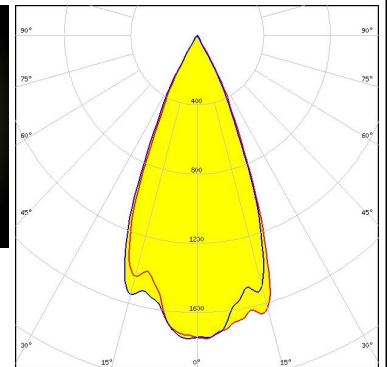
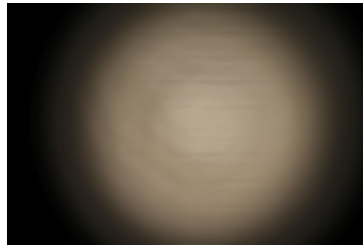

LED CMT19xx  
 FWHM / FWTM 47.0° / 61.0°  
 Efficiency 86 %  
 Peak intensity 1.6 cd/m  
 LEDs/each optic 1  
 Light colour White

Required components:

C13868\_LENA-STD-BASE-VERO13-18  
 Bender Wirth: 477 Typ L1

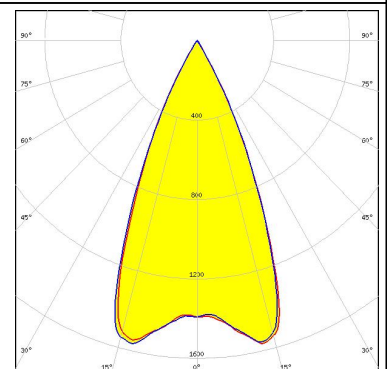
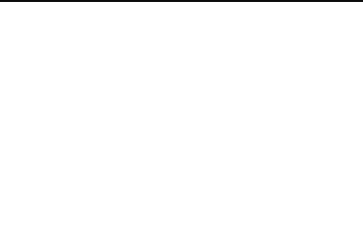

LED CMT28xx  
 FWHM / FWTM 51.0° / 64.0°  
 Efficiency 86 %  
 Peak intensity 1.5 cd/m  
 LEDs/each optic 1  
 Light colour White

Required components:

C12692\_LENA-STD-BASE-CLL040

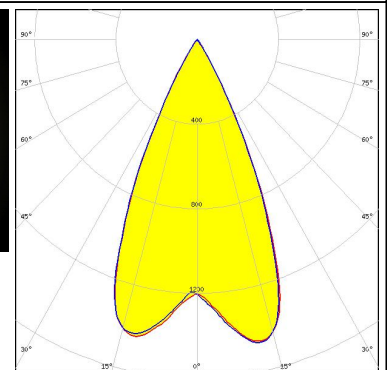
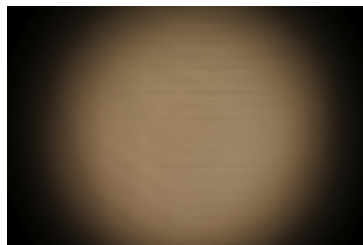

LED CMT28xx  
 FWHM / FWTM 54.0° / 66.0°  
 Efficiency 85 %  
 Peak intensity 1.4 cd/m  
 LEDs/each optic 1  
 Light colour White

Required components:

C13867\_LENA-STD-BASE-VERO29  
 Bender Wirth: 471 Typ L3

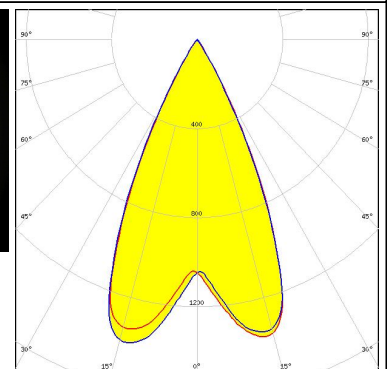
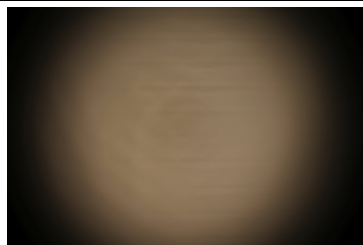

### OPTICAL RESULTS (MEASURED):



LED CXA/B 15xx  
 FWHM / FWTM 38.0° / 59.0°  
 Efficiency 77 %  
 Peak intensity 1.9 cd/lm  
 LEDs/each optic 1  
 Light colour White  
 Required components:  
 C13186\_LENA-STD-BASE-CXA15  
 C11996\_LENA-LENS

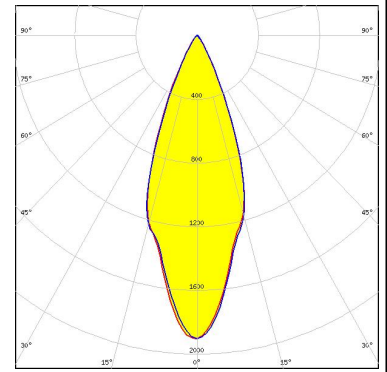

LED CXA/B 15xx  
 FWHM / FWTM 44.0° / 61.0°  
 Efficiency 81 %  
 Peak intensity 1.7 cd/lm  
 LEDs/each optic 1  
 Light colour White  
 Required components:  
 C13868\_LENA-STD-BASE-VERO13-18  
 C11996\_LENA-LENS  
 Bender Wirth: 441 Typ L1

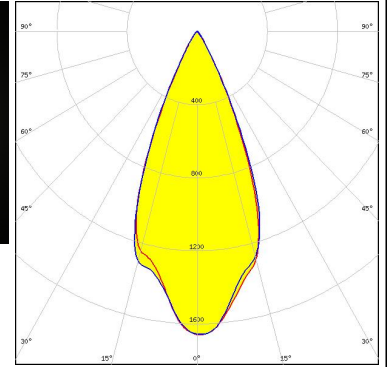
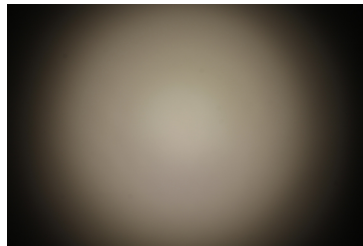

LED CXA/B 1830  
 FWHM / FWTM 49.0° / 60.0°  
 Efficiency 82 %  
 Peak intensity 1.5 cd/lm  
 LEDs/each optic 1  
 Light colour White  
 Required components:  
 C13868\_LENA-STD-BASE-VERO13-18  
 C14169\_LENA-CLEAR-LENS  
 Bender Wirth: 437 Typ L1

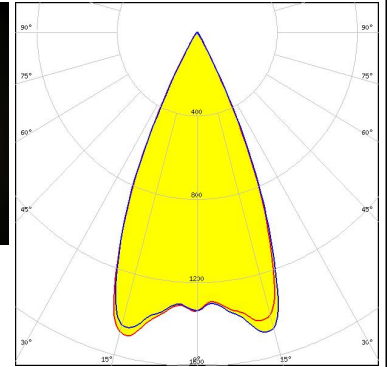
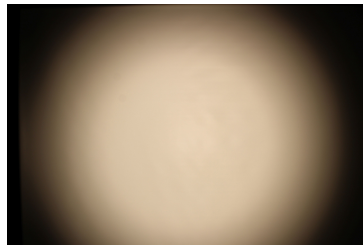

LED CXA/B 1830  
 FWHM / FWTM 48.0° / 61.0°  
 Efficiency 87 %  
 Peak intensity 1.7 cd/lm  
 LEDs/each optic 1  
 Light colour White  
 Required components:  
 C13868\_LENA-STD-BASE-VERO13-18  
 Bender Wirth: 437 Typ L1

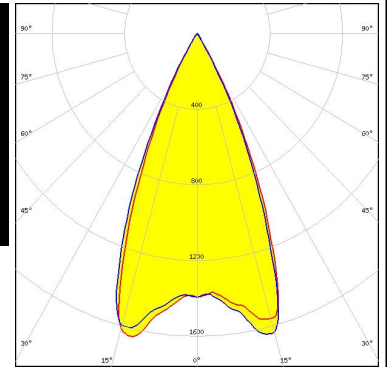
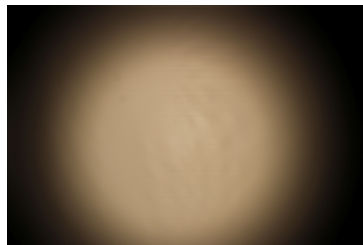

### OPTICAL RESULTS (MEASURED):



LED CXA/B 1830  
 FWHM / FWTM 17.0° / 64.0°  
 Efficiency 74 %  
 Peak intensity 2.2 cd/lm  
 LEDs/each optic 1  
 Light colour White  
 Required components:  
 C13868\_LENA-STD-BASE-VERO13-18  
 C12231\_LENA-FRESNEL  
 Bender Wirth: 437 Typ L1

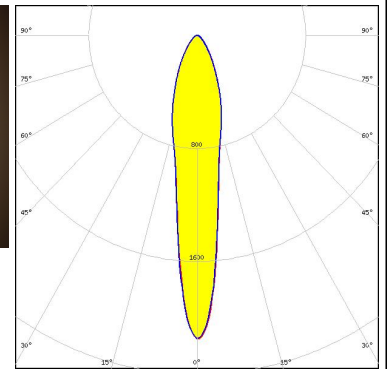
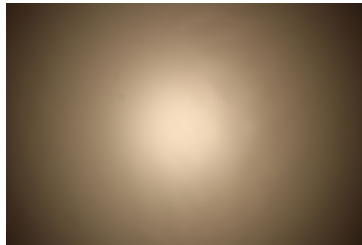

LED CXA/B 25xx  
 FWHM / FWTM 44.0° / 60.0°  
 Efficiency 81 %  
 Peak intensity 1.5 cd/lm  
 LEDs/each optic 1  
 Light colour White  
 Required components:  
 C13324\_LENA-STD-BASE-CXA25

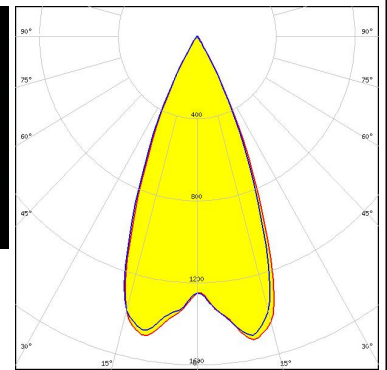

LED CXA/B 25xx  
 FWHM / FWTM 44.0° / 61.0°  
 Efficiency 76 %  
 Peak intensity 1.3 cd/lm  
 LEDs/each optic 1  
 Light colour White  
 Required components:  
 C13324\_LENA-STD-BASE-CXA25  
 C11996\_LENA-LENS

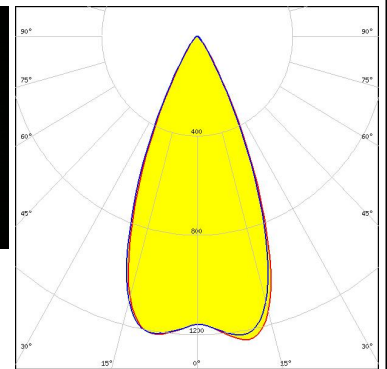

LED CXA2011  
 FWHM / FWTM 42.0°  
 Efficiency 75 %  
 LEDs/each optic 1  
 Light colour White  
 Required components:  
 C12105\_LENA-STD-BASE-CXA20  
 C11996\_LENA-LENS

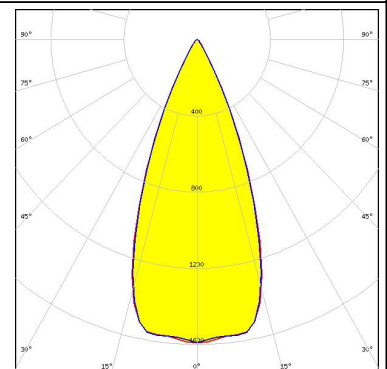

#### OPTICAL RESULTS (MEASURED):

#### EVERLIGHT

LED CHI3030 19W  
 FWHM / FWTM 50.0° / 70.0°  
 Efficiency 81 %  
 Peak intensity 1.2 cd/lm  
 LEDs/each optic 1  
 Light colour White

Required components:

C13867\_LENA-STD-BASE-VERO29  
 C11996\_LENA-LENS  
 Bender Wirth: 468 Typ L3

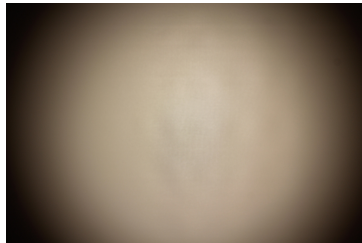

#### EVERLIGHT

LED CHI3030 29W  
 FWHM / FWTM 53.0° / 76.0°  
 Efficiency 78 %  
 Peak intensity 1 cd/lm  
 LEDs/each optic 1  
 Light colour White

Required components:

C13867\_LENA-STD-BASE-VERO29  
 C11996\_LENA-LENS  
 Bender Wirth: 468 Typ L3

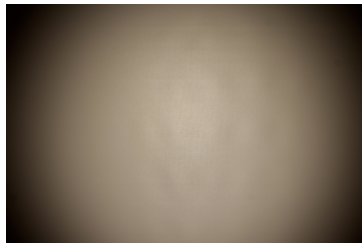

#### LUMILEDS

LED LUXEON CoB 1204/1205  
 FWHM / FWTM 44.0° / 66.0°  
 Efficiency 68 %  
 Peak intensity 1.2 cd/lm  
 LEDs/each optic 1  
 Light colour White

Required components:

C12292\_LENA-STD-BASE-MEZ  
 C11996\_LENA-LENS

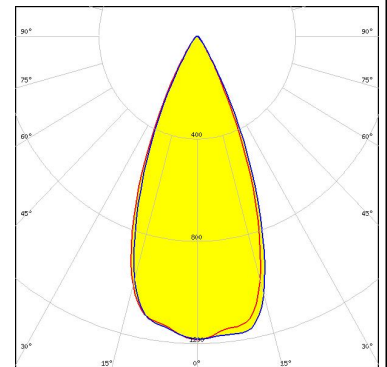

#### LUMILEDS

LED LUXEON CoB 1204HD  
 FWHM / FWTM 40.0° / 58.0°  
 Efficiency 86 %  
 Peak intensity 2.2 cd/lm  
 LEDs/each optic 1  
 Light colour White

Required components:

C11981\_LENA-STD-BASE-COB-L110

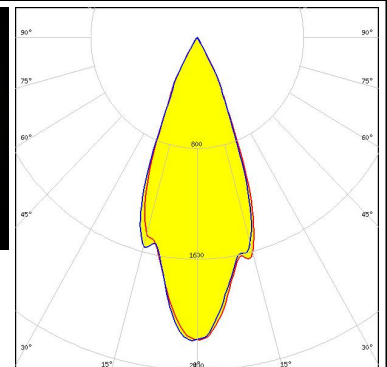

### OPTICAL RESULTS (MEASURED):

#### LUMILEDS

LED LUXEON CoB 1205HD  
 FWHM / FWTM 43.0° / 60.0°  
 Efficiency 85 %  
 Peak intensity 1.8 cd/lm  
 LEDs/each optic 1  
 Light colour White  
 Required components:  
 C11981\_LENA-STD-BASE-COB-L110

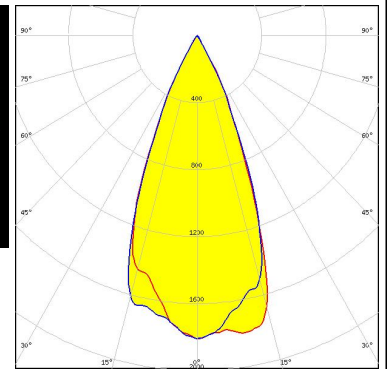

#### LUMILEDS

LED LUXEON CoB 1208  
 FWHM / FWTM 46.0° / 67.0°  
 Efficiency 68 %  
 Peak intensity 1.1 cd/lm  
 LEDs/each optic 1  
 Light colour White  
 Required components:  
 C12292\_LENA-STD-BASE-MEZ  
 C11996\_LENA-LENS

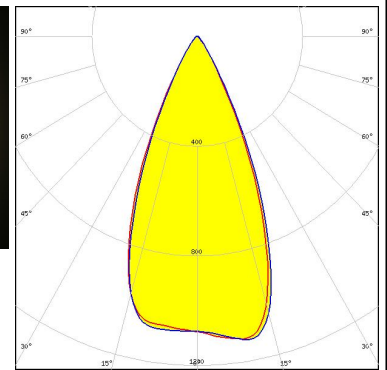
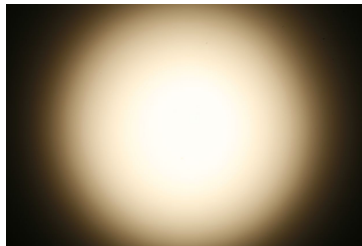

#### LUMILEDS

LED LUXEON CoB 1208  
 FWHM / FWTM 46.0° / 62.0°  
 Efficiency 73 %  
 Peak intensity 1.4 cd/lm  
 LEDs/each optic 1  
 Light colour White  
 Required components:  
 C12292\_LENA-STD-BASE-MEZ

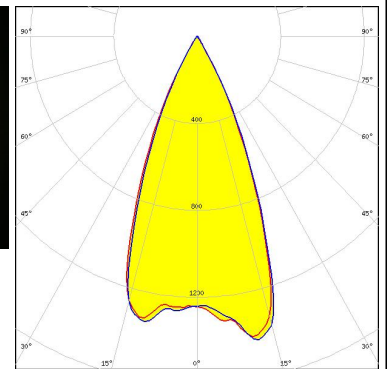

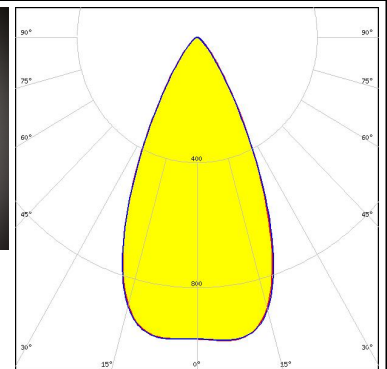
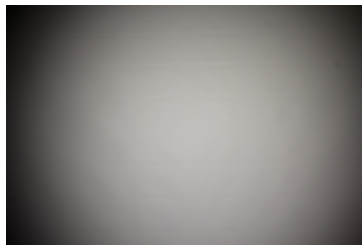

#### LUMILEDS

LED LUXEON CoB 1213/1216/1812  
 FWHM / FWTM 50.0° / 79.0°  
 Efficiency 75 %  
 Peak intensity 1 cd/lm  
 LEDs/each optic 1  
 Light colour White  
 Required components:  
 C11996\_LENA-LENS  
 A.A.G. STUCCHI: 8102-G2 + S-8000-12

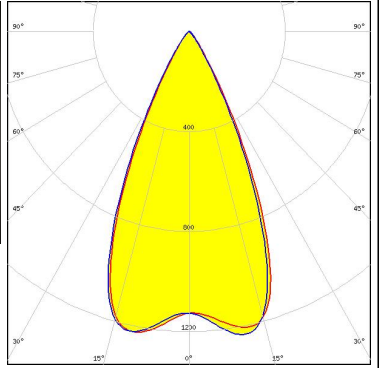
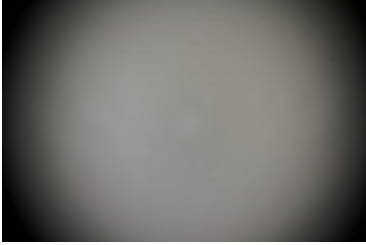
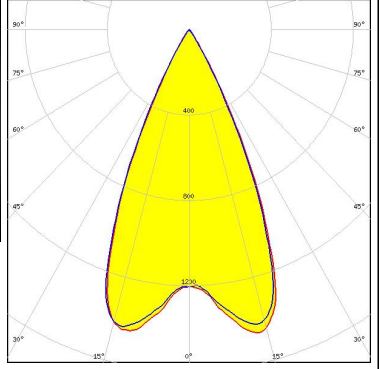
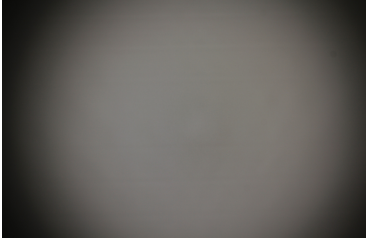
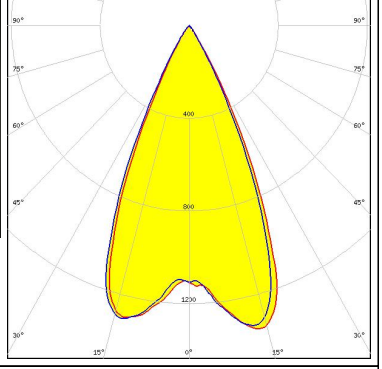

### OPTICAL RESULTS (MEASURED):

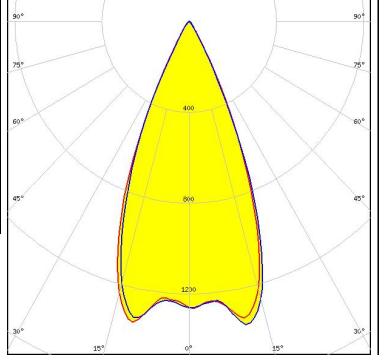
<p><b>LUMILEDS</b></p> <p>LED LUXEON CoB 1213/1216/1812</p> <p>FWHM / FWTM 50.0° / 69.0°</p> <p>Efficiency 81 %</p> <p>Peak intensity 1.2 cd/lm</p> <p>LEDs/each optic 1</p> <p>Light colour White</p> <p>Required components: C12692_LENA-STD-BASE-CLL040 C11996_LENA-LENS</p>		
<p><b>LUMILEDS</b></p> <p>LED LUXEON CoB 1213/1216/1812</p> <p>FWHM / FWTM 51.0° / 64.0°</p> <p>Efficiency 86 %</p> <p>Peak intensity 1.5 cd/lm</p> <p>LEDs/each optic 1</p> <p>Light colour White</p> <p>Required components: C12692_LENA-STD-BASE-CLL040</p>		
<p><b>LUMILEDS</b></p> <p>LED LUXEON CoB 1213/1216/1812</p> <p>FWHM / FWTM 51.0° / 65.0°</p> <p>Efficiency 79 %</p> <p>Peak intensity 1.4 cd/lm</p> <p>LEDs/each optic 1</p> <p>Light colour White</p> <p>Required components: A.A.G. STUCCHI: 8102-G2 + S-8000-12</p>		
<p><b>LUMILEDS</b></p> <p>LED LUXEON K12</p> <p>FWHM / FWTM 45.0° / 61.0°</p> <p>Efficiency 74 %</p> <p>Peak intensity 1.4 cd/lm</p> <p>LEDs/each optic 1</p> <p>Light colour White</p> <p>Required components: C12924_LENA-STD-BASE-LUXEON-K C11996_LENA-LENS</p>		

### OPTICAL RESULTS (MEASURED):

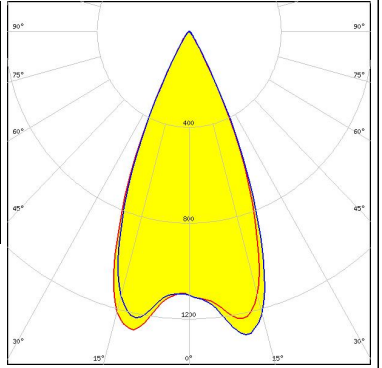
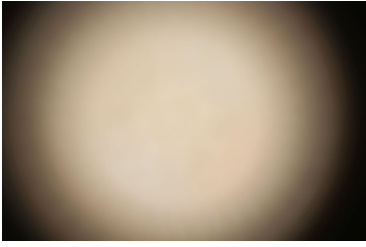
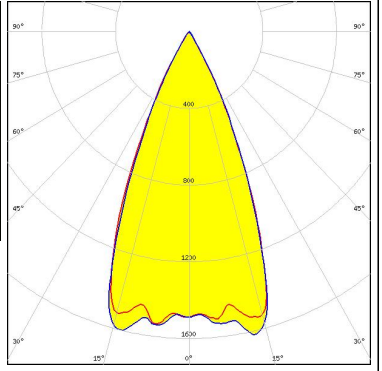
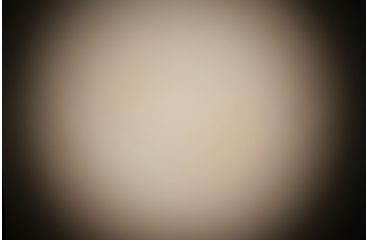
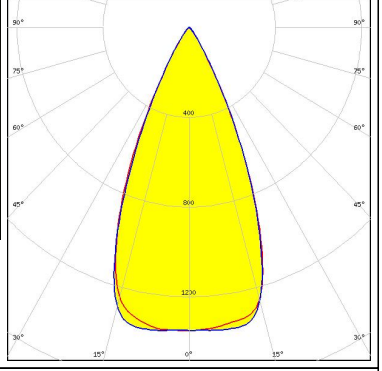
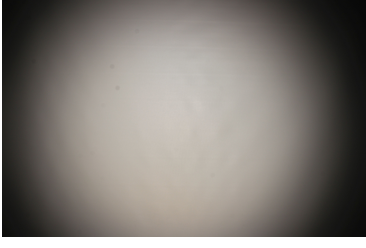
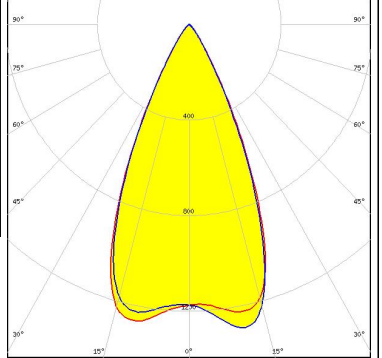
<p><b>LUMILEDS</b></p> <p>LED LUXEON K16            FWHM / FWTM 46.0° / 62.0°            Efficiency 72 %            Peak intensity 1.3 cd/m            LEDs/each optic 1            Light colour White</p> <p>Required components:            C12924_LENA-STD-BASE-LUXEON-K            C11996_LENA-LENS</p>		
<p><b>LUMINUS</b></p> <p>LED CDM-14 (Dim-To-Warm)            FWHM / FWTM 47.0° / 61.0°            Efficiency 87 %            Peak intensity 1.7 cd/m            LEDs/each optic 1            Light colour White</p> <p>Required components:            C13868_LENA-STD-BASE-VERO13-18            Bender Wirth: 491 Typ L2</p>		
<p><b>LUMINUS</b></p> <p>LED CDM-14 (Dim-To-Warm)            FWHM / FWTM 47.0° / 67.0°            Efficiency 82 %            Peak intensity 1.4 cd/m            LEDs/each optic 1            Light colour White</p> <p>Required components:            C13868_LENA-STD-BASE-VERO13-18            C11996_LENA-LENS            Bender Wirth: 491 Typ L2</p>		
<p><b>LUMINUS</b></p> <p>LED CDM-18 (Dim-To-Warm)            FWHM / FWTM 48.0° / 68.0°            Efficiency 82 %            Peak intensity 1.3 cd/m            LEDs/each optic 1            Light colour White</p> <p>Required components:            C13868_LENA-STD-BASE-VERO13-18            C11996_LENA-LENS            Bender Wirth: 491 Typ L2</p>		

### OPTICAL RESULTS (MEASURED):



LED CDM-18 (Dim-To-Warm)  
 FWHM / FWTM 50.0° / 63.0°  
 Efficiency 87 %  
 Peak intensity 1.6 cd/lm  
 LEDs/each optic 1  
 Light colour White  
 Required components:  
 C13868\_LENA-STD-BASE-VERO13-18  
 Bender Wirth: 491 Typ L2

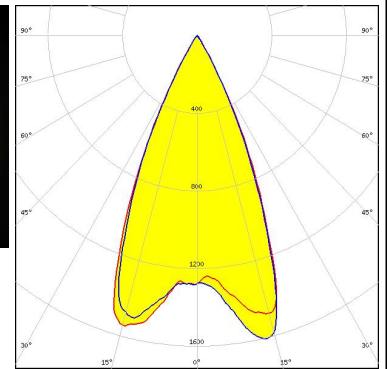
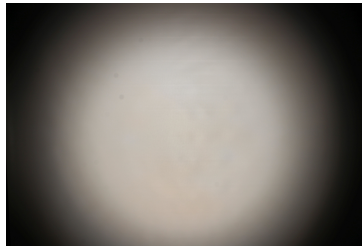

LED CDM-9 (Dim-To-Warm)  
 FWHM / FWTM 44.0° / 59.0°  
 Efficiency 87 %  
 Peak intensity 1.9 cd/lm  
 LEDs/each optic 1  
 Light colour White  
 Required components:  
 C13868\_LENA-STD-BASE-VERO13-18  
 Bender Wirth: 490 Typ L1

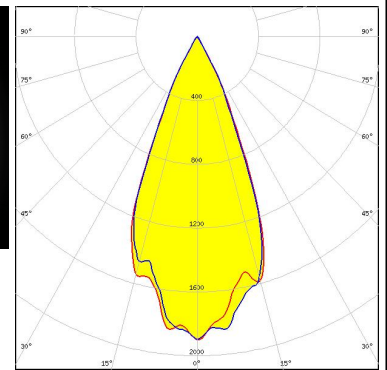
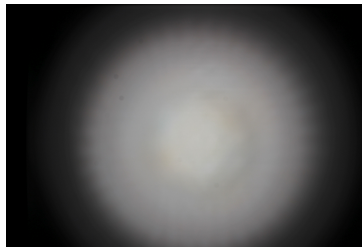

LED CDM-9 (Dim-To-Warm)  
 FWHM / FWTM 44.0° / 63.0°  
 Efficiency 82 %  
 Peak intensity 1.6 cd/lm  
 LEDs/each optic 1  
 Light colour White  
 Required components:  
 C13868\_LENA-STD-BASE-VERO13-18  
 C11996\_LENA-LENS  
 Bender Wirth: 490 Typ L1

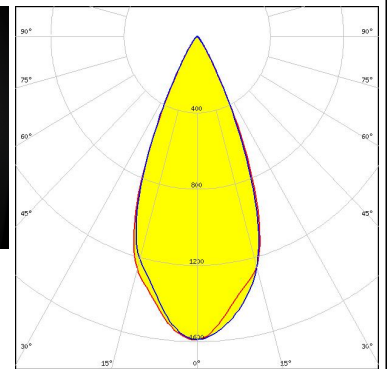

LED CTM-14 (Tunable White)  
 FWHM / FWTM 46.0° / 65.0°  
 Efficiency 81 %  
 Peak intensity 1.4 cd/lm  
 LEDs/each optic 1  
 Light colour White  
 Required components:  
 C13867\_LENA-STD-BASE-VERO29  
 C12606\_LENINA-DL  
 Bender Wirth: 442 Typ L3

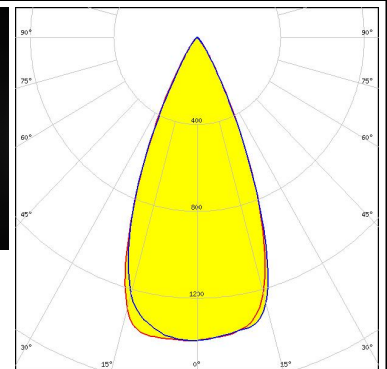
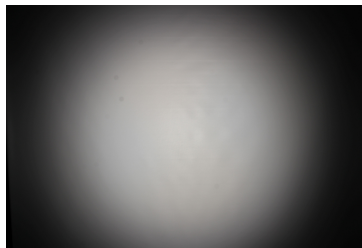



### OPTICAL RESULTS (MEASURED):



LED CTM-14 (Tunable White)  
 FWHM / FWTM 45.0° / 61.0°  
 Efficiency 86 %  
 Peak intensity 1.7 cd/m  
 LEDs/each optic 1  
 Light colour White  
 Required components:  
 C13867\_LENA-STD-BASE-VERO29  
 Bender Wirth: 442 Typ L3

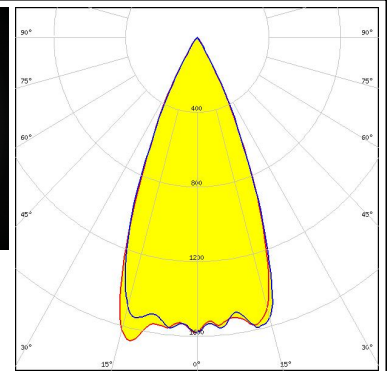
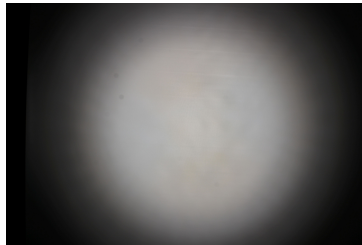

LED CTM-18 (Tunable White)  
 FWHM / FWTM 49.0° / 63.0°  
 Efficiency 87 %  
 Peak intensity 1.6 cd/m  
 LEDs/each optic 1  
 Light colour White  
 Required components:  
 C13867\_LENA-STD-BASE-VERO29  
 Bender Wirth: 442 Typ L3

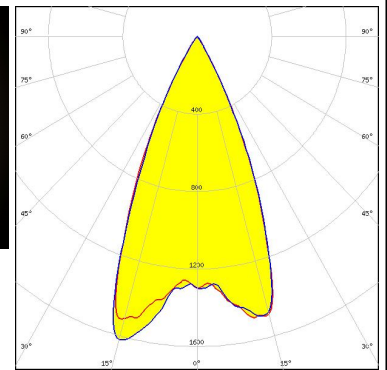

LED CTM-18 (Tunable White)  
 FWHM / FWTM 49.0° / 69.0°  
 Efficiency 81 %  
 Peak intensity 1.3 cd/m  
 LEDs/each optic 1  
 Light colour White  
 Required components:  
 C13867\_LENA-STD-BASE-VERO29  
 C11996\_LENA-LENS  
 Bender Wirth: 442 Typ L3

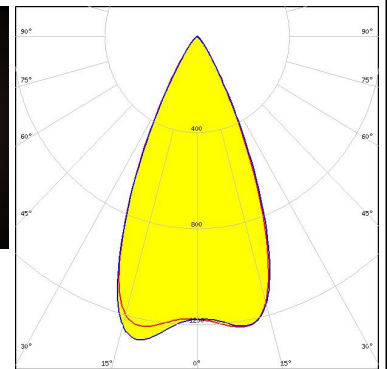
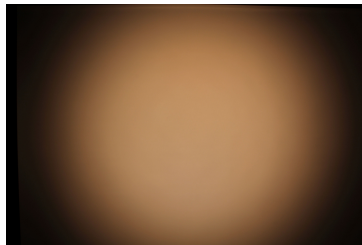

LED CTM-22 (Tunable White)  
 FWHM / FWTM 55.0° / 68.0°  
 Efficiency 86 %  
 Peak intensity 1.4 cd/m  
 LEDs/each optic 1  
 Light colour White  
 Required components:  
 C13867\_LENA-STD-BASE-VERO29  
 Bender Wirth: 494 Typ L3

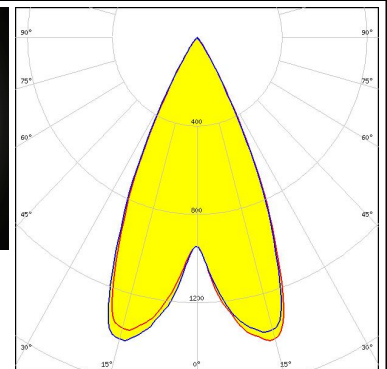
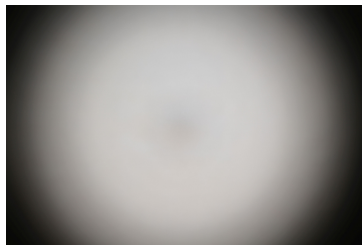

### OPTICAL RESULTS (MEASURED):



LED CTM-22 (Tunable White)  
 FWHM / FWTM 53.0° / 72.0°  
 Efficiency 81 %  
 Peak intensity 1.2 cd/m  
 LEDs/each optic 1  
 Light colour White  
 Required components:  
 C13867\_LENA-STD-BASE-VERO29  
 C11996\_LENA-LENS  
 Bender Wirth: 489 Typ L6

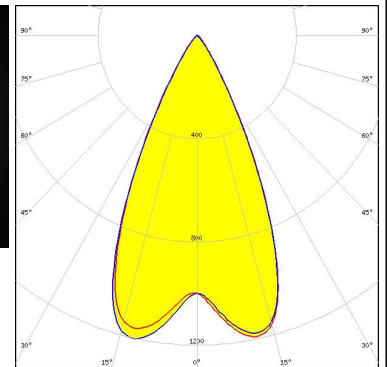
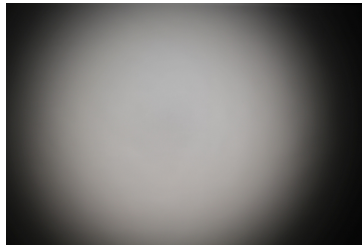

LED CxM-14 (19x19)  
 FWHM / FWTM 48.0° / 68.0°  
 Efficiency 78 %  
 Peak intensity 1.3 cd/m  
 LEDs/each optic 1  
 Light colour White  
 Required components:  
 C12691\_LENA-STD-BASE-CLL030  
 C11996\_LENA-LENS

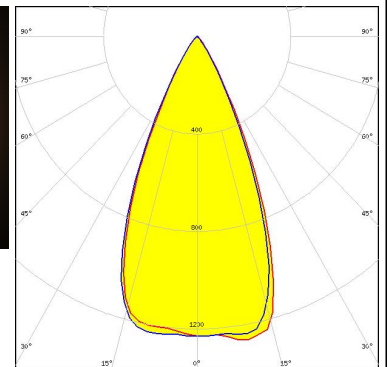
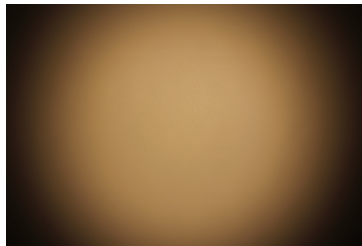

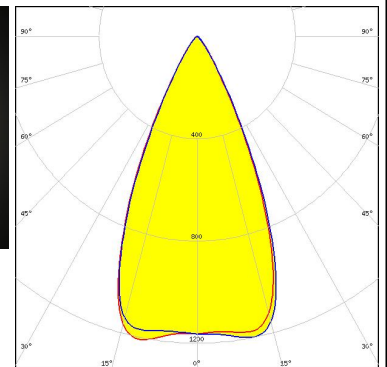
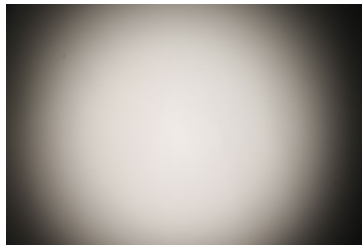

LED COB J-Type  
 FWHM / FWTM 49.0° / 69.0°  
 Efficiency 79 %  
 Peak intensity 1.2 cd/m  
 LEDs/each optic 1  
 Light colour White  
 Required components:  
 C13868\_LENA-STD-BASE-VERO13-18  
 C11996\_LENA-LENS  
 Bender Wirth: 463 Typ L2

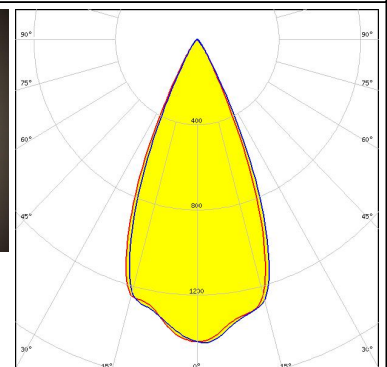
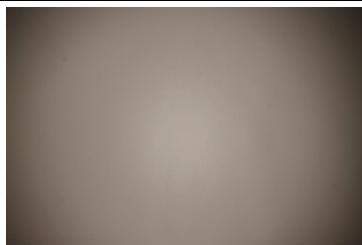

LED COB L-Type (LES 11)  
 FWHM / FWTM 46.0° / 63.0°  
 Efficiency 79 %  
 Peak intensity 1.4 cd/m  
 LEDs/each optic 1  
 Light colour White  
 Required components:  
 C13868\_LENA-STD-BASE-VERO13-18  
 C11996\_LENA-LENS  
 Bender Wirth: 438 Typ L1

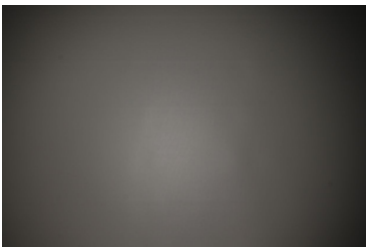
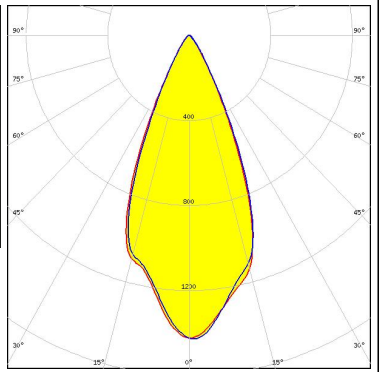
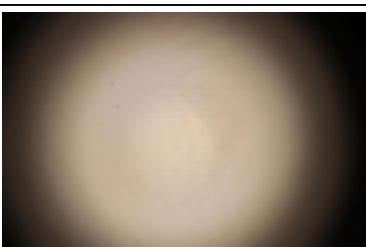
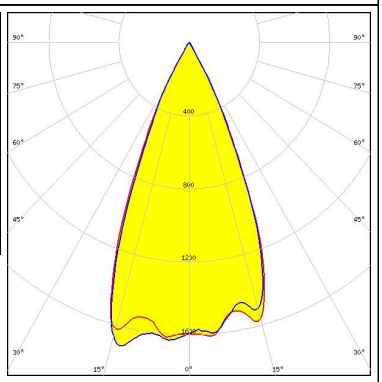
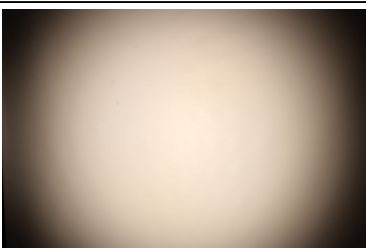
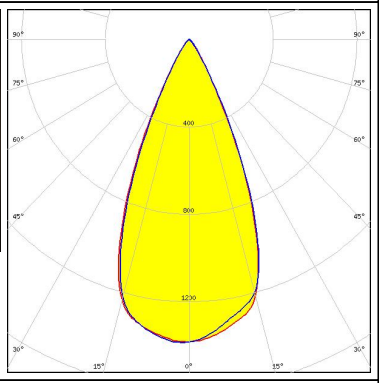

### OPTICAL RESULTS (MEASURED):

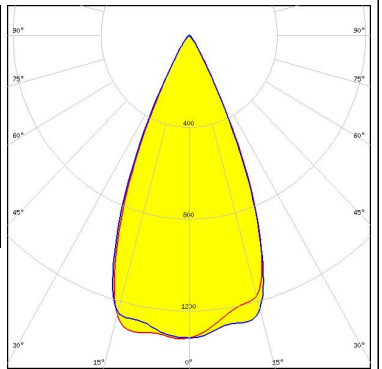
<p><b>NICHIA</b></p> <p>LED COB L-Type (LES 9)</p> <p>FWHM / FWTM 45.0° / 66.0°</p> <p>Efficiency 79 %</p> <p>Peak intensity 1.4 cd/lm</p> <p>LEDs/each optic 1</p> <p>Light colour White</p> <p>Required components: C13868_LENA-STD-BASE-VERO13-18 C11996_LENA-LENS Bender Wirth: 438 Typ L1</p>		
<p><b>NICHIA</b></p> <p>LED NVCWJ024Z-V1MT: COB J-Type Tunable White</p> <p>FWHM / FWTM 45.0° / 60.0°</p> <p>Efficiency 86 %</p> <p>Peak intensity 1.7 cd/lm</p> <p>LEDs/each optic 1</p> <p>Light colour White</p> <p>Required components: C13868_LENA-STD-BASE-VERO13-18 Bender Wirth: 498 Typ L2</p>		
<p><b>NICHIA</b></p> <p>LED NVCWJ024Z-V1MT: COB J-Type Tunable White</p> <p>FWHM / FWTM 46.0° / 66.0°</p> <p>Efficiency 81 %</p> <p>Peak intensity 1.4 cd/lm</p> <p>LEDs/each optic 1</p> <p>Light colour White</p> <p>Required components: C13868_LENA-STD-BASE-VERO13-18 C11996_LENA-LENS Bender Wirth: 498 Typ L2</p>		
<p><b>OSRAM</b> Opto Semiconductors</p> <p>LED Soleriq S13</p> <p>FWHM / FWTM 47.0° / 64.0°</p> <p>Efficiency 78 %</p> <p>Peak intensity 1.4 cd/lm</p> <p>LEDs/each optic 1</p> <p>Light colour White</p> <p>Required components: C13868_LENA-STD-BASE-VERO13-18 C11996_LENA-LENS Bender Wirth: 437 Typ L1</p>		

#### OPTICAL RESULTS (MEASURED):

#### OSRAM

Opto Semiconductors

LED Soleriq S19  
 FWHM / FWTM 50.0° / 71.0°  
 Efficiency 78 %  
 Peak intensity 1.2 cd/m  
 LEDs/each optic 1  
 Light colour White

Required components:

C13867\_LENA-STD-BASE-VERO29  
 C11996\_LENA-LENS  
 Bender Wirth: 462 Typ L3

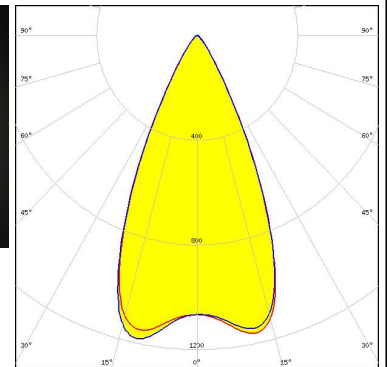
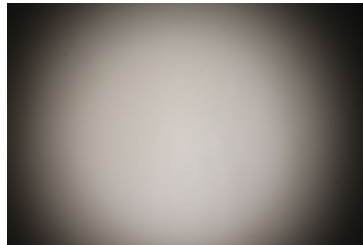

#### PHILIPS

LED Fortimo SLM L13 CoB  
 FWHM / FWTM 44.0° / 60.0°  
 Efficiency 85 %  
 Peak intensity 1.8 cd/m  
 LEDs/each optic 1  
 Light colour White

Required components:

C12292\_LENA-STD-BASE-MEZ

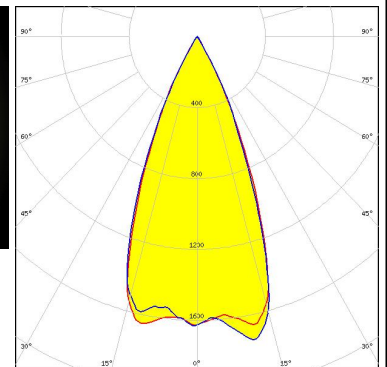

#### PHILIPS

LED Fortimo SLM L13 CoB  
 FWHM / FWTM 44.0° / 61.0°  
 Efficiency 79 %  
 Peak intensity 1.5 cd/m  
 LEDs/each optic 1  
 Light colour White

Required components:

C12292\_LENA-STD-BASE-MEZ  
 C11996\_LENA-LENS

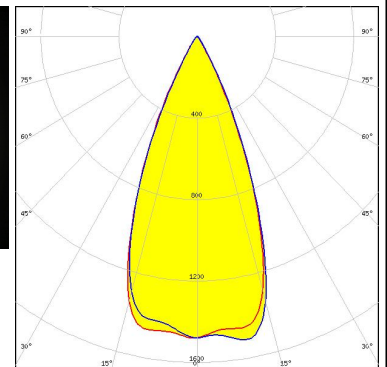
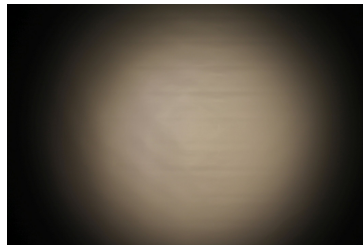

#### PHILIPS

LED Fortimo SLM L15 CoB  
 FWHM / FWTM 47.0° / 61.0°  
 Efficiency 85 %  
 Peak intensity 1.7 cd/m  
 LEDs/each optic 1  
 Light colour White

Required components:

C12292\_LENA-STD-BASE-MEZ

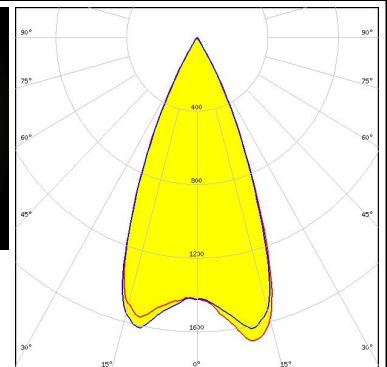
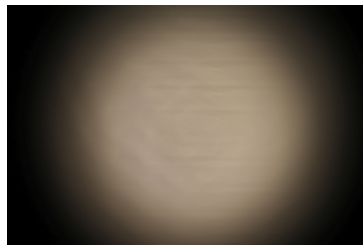

#### OPTICAL RESULTS (MEASURED):

### PHILIPS

LED Fortimo SLM L15 CoB  
 FWHM / FWTM 46.0° / 63.0°  
 Efficiency 79 %  
 Peak intensity 1.4 cd/m  
 LEDs/each optic 1  
 Light colour White  
 Required components:  
 C12292\_LENA-STD-BASE-MEZ  
 C11996\_LENA-LENS

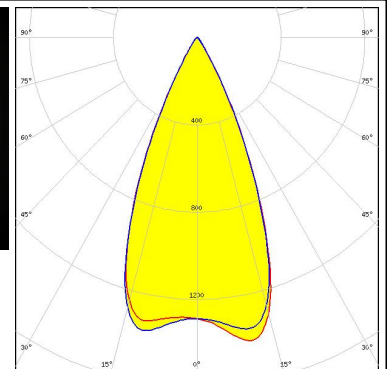
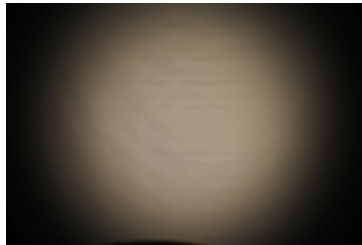

### PHILIPS

LED Fortimo SLM L19 CoB  
 FWHM / FWTM 50.0° / 63.0°  
 Efficiency 85 %  
 Peak intensity 1.6 cd/m  
 LEDs/each optic 1  
 Light colour White  
 Required components:  
 C12692\_LENA-STD-BASE-CLL040

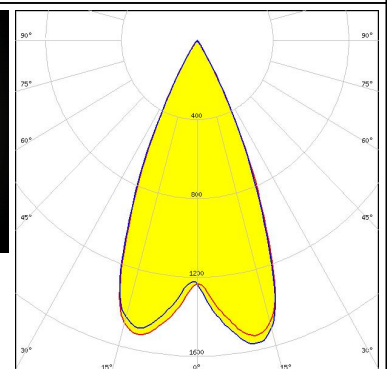

### PHILIPS

LED Fortimo SLM L19 CoB  
 FWHM / FWTM 48.0° / 65.0°  
 Efficiency 79 %  
 Peak intensity 1.3 cd/m  
 LEDs/each optic 1  
 Light colour White  
 Required components:  
 C12692\_LENA-STD-BASE-CLL040  
 C11996\_LENA-LENS

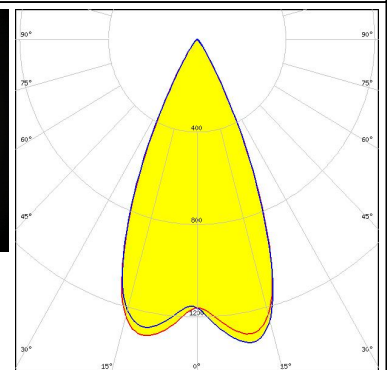
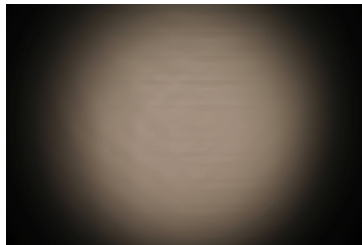

### PHILIPS

LED Fortimo SLM L23 CoB  
 FWHM / FWTM 50.0° / 67.0°  
 Efficiency 79 %  
 Peak intensity 1.2 cd/m  
 LEDs/each optic 1  
 Light colour White  
 Required components:  
 C12692\_LENA-STD-BASE-CLL040  
 C11996\_LENA-LENS

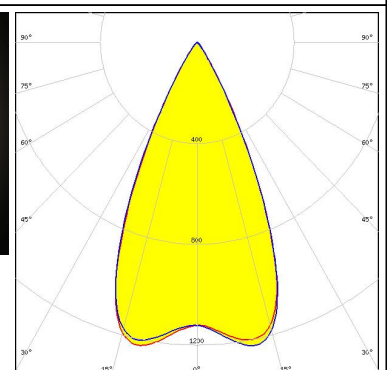
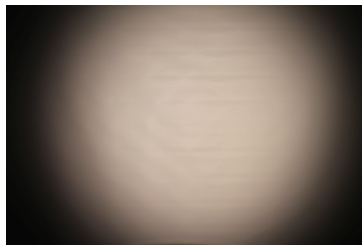

### OPTICAL RESULTS (MEASURED):

#### PHILIPS

LED Fortimo SLM L23 CoB  
 FWHM / FWTM 51.0° / 64.0°  
 Efficiency 85 %  
 Peak intensity 1.5 cd/m  
 LEDs/each optic 1  
 Light colour White  
 Required components:  
 C12692\_LENA-STD-BASE-CLL040

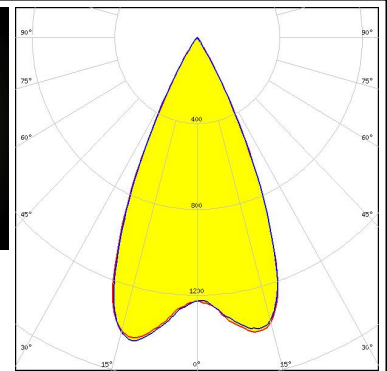
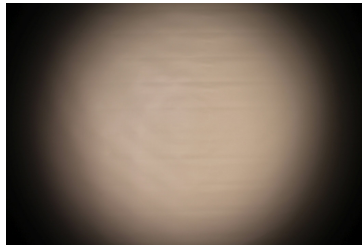

#### SAMSUNG

LED LC016D / LC019D / LC026D / LC033D  
 FWHM / FWTM 49.0° / 66.0°  
 Efficiency 81 %  
 Peak intensity 1.3 cd/m  
 LEDs/each optic 1  
 Light colour White  
 Required components:  
 C12691\_LENA-STD-BASE-CLL030  
 C11996\_LENA-LENS

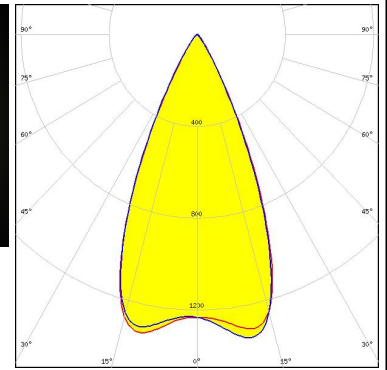
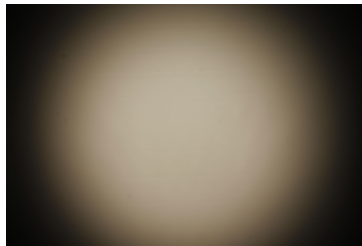

#### SAMSUNG

LED LC040D / LC060D / LC080D  
 FWHM / FWTM 51.0° / 71.0°  
 Efficiency 81 %  
 Peak intensity 1.2 cd/m  
 LEDs/each optic 1  
 Light colour White  
 Required components:  
 C12692\_LENA-STD-BASE-CLL040  
 C11996\_LENA-LENS

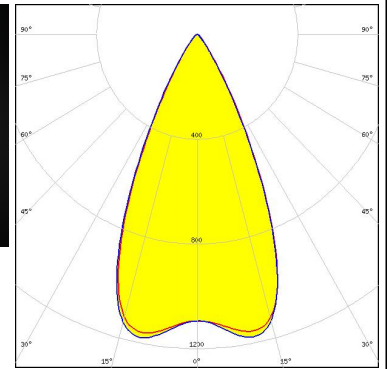
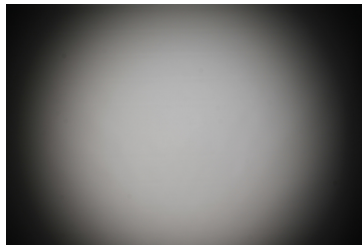

SEOUL SEMICONDUCTOR

LED ZC12/18  
 FWHM / FWTM 48.0° / 66.0°  
 Efficiency 77 %  
 Peak intensity 1.3 cd/m  
 LEDs/each optic 1  
 Light colour White  
 Required components:  
 C12691\_LENA-STD-BASE-CLL030  
 C11996\_LENA-LENS

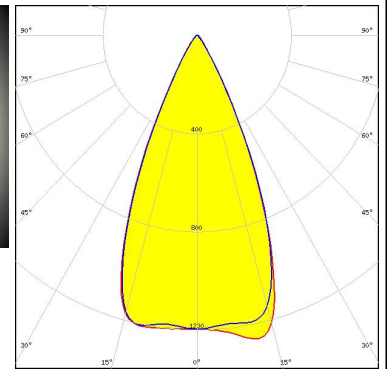
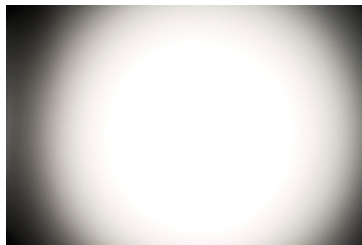

#### OPTICAL RESULTS (MEASURED):

### SHARP

LED Mega Zenigata (GW5DGC)  
 FWHM / FWTM 44.0° / 60.0°  
 Efficiency 80 %  
 LEDs/each optic 1  
 Light colour White  
 Required components:  
 C12292\_LENA-STD-BASE-MEZ

### SHARP

LED Mega Zenigata (GW5DGC)  
 FWHM / FWTM 44.0° / 64.0°  
 Efficiency 75 %  
 LEDs/each optic 1  
 Light colour White  
 Required components:  
 C12292\_LENA-STD-BASE-MEZ  
 C11996\_LENA-LENS

### TRIDONIC

LED SLE G7 LES15  
 FWHM / FWTM 48.0° / 62.0°  
 Efficiency 88 %  
 Peak intensity 1.7 cd/lm  
 LEDs/each optic 1  
 Light colour White  
 Required components:  
 C12691\_LENA-STD-BASE-CLL030

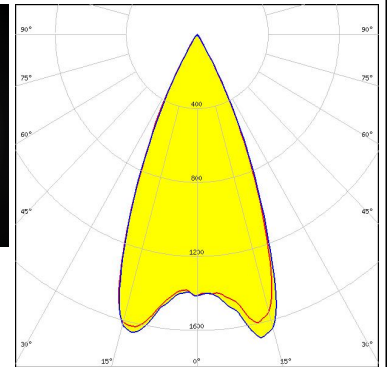
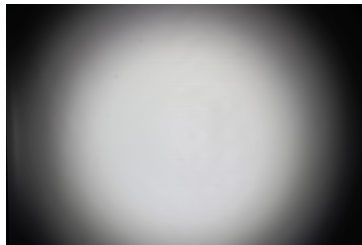

### TRIDONIC

LED SLE G7 LES17 H  
 FWHM / FWTM 49.0° / 62.0°  
 Efficiency 86 %  
 Peak intensity 1.6 cd/lm  
 LEDs/each optic 1  
 Light colour White  
 Required components:  
 C14547\_LENA-ADAPTER-B

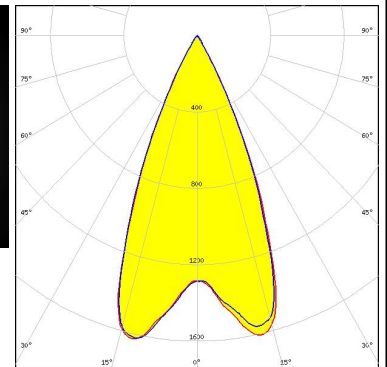
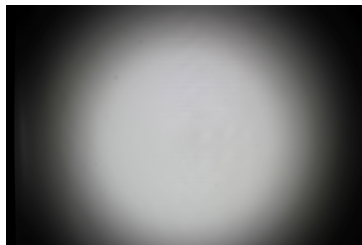

### OPTICAL RESULTS (MEASURED):

#### TRIDONIC

LED SLE G7 LES21 H  
FWHM / FWTM 52.0° / 64.0°  
Efficiency 86 %  
Peak intensity 1.5 cd/lm  
LEDs/each optic 1  
Light colour White  
Required components:  
C14547\_LENA-ADAPTER-B

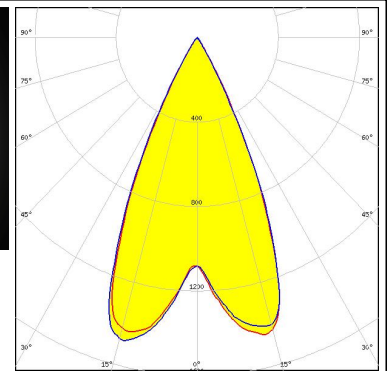





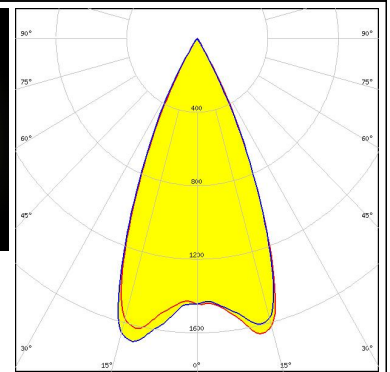
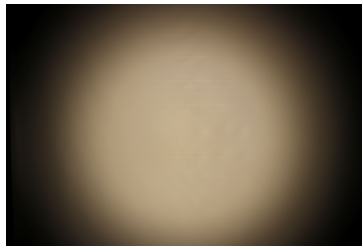

#### XICATO

LED XOB 14.5 mm  
FWHM / FWTM 46.0° / 60.0°  
Efficiency 89 %  
Peak intensity 1.7 cd/lm  
LEDs/each optic 1  
Light colour White  
Required components:  
C12691\_LENA-STD-BASE-CLL030

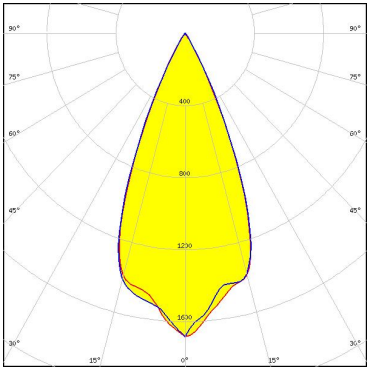

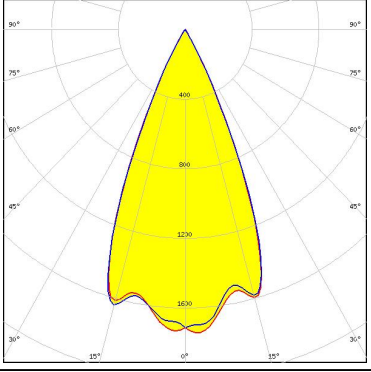

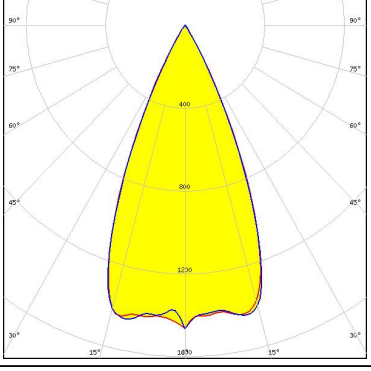

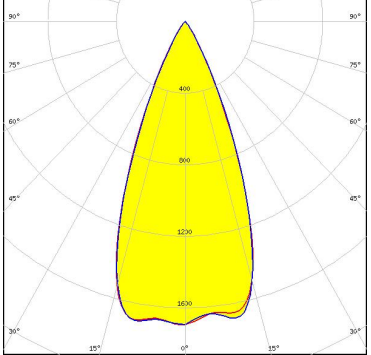

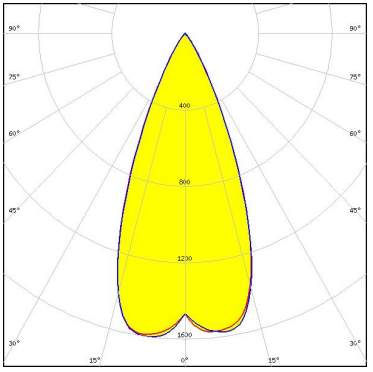

### OPTICAL RESULTS (SIMULATED):

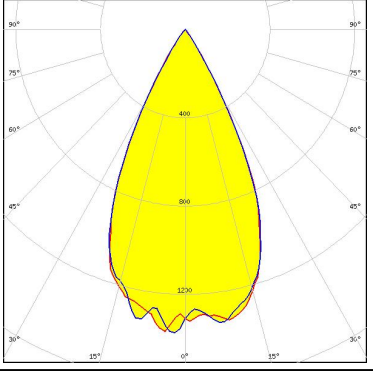
<p></p> <p>LED V10 Gen7            FWHM / FWTM 44.0° / 60.0°            Efficiency 81 %            Peak intensity 1.7 cd/lm            LEDs/each optic 1            Light colour White</p> <p>Required components:            C13868_LENA-STD-BASE-VERO13-18            C11996_LENA-LENS            Bender Wirth: 486 Typ L1</p>	
<p></p> <p>LED V10 Gen7            FWHM / FWTM 46.0° / 59.0°            Efficiency 88 %            Peak intensity 1.8 cd/lm            LEDs/each optic 1            Light colour White</p> <p>Required components:            C13868_LENA-STD-BASE-VERO13-18            Bender Wirth: 486 Typ L1</p>	
<p></p> <p>LED V13 Gen7            FWHM / FWTM 47.0° / 63.0°            Efficiency 82 %            Peak intensity 1.5 cd/lm            LEDs/each optic 1            Light colour White</p> <p>Required components:            C13868_LENA-STD-BASE-VERO13-18            C11996_LENA-LENS            Bender Wirth: 477 Typ L1</p>	
<p></p> <p>LED V13 Gen7            FWHM / FWTM 44.0° / 62.0°            Efficiency 87 %            Peak intensity 1.7 cd/lm            LEDs/each optic 1            Light colour White</p> <p>Required components:            IDEAL: 50-2103CT + 50-2100LN</p>	

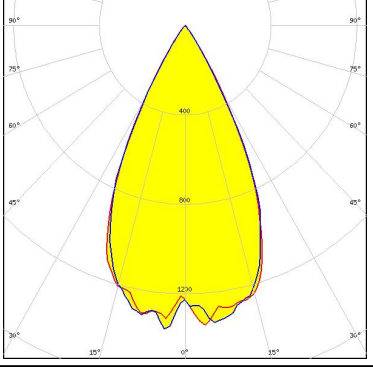
### OPTICAL RESULTS (SIMULATED):

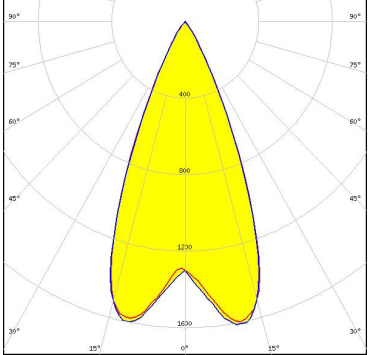
<p></p> <p>LED V13 Gen7            FWHM / FWTM 42.0° / 64.0°            Efficiency 85 %            Peak intensity 1.6 cd/lm            LEDs/each optic 1            Light colour White            Required components:            C11996_LENA-LENS            IDEAL: 50-2103CT + 50-2100LN</p>	
<p></p> <p>LED V22 Gen7            FWHM / FWTM 51.0° / 67.0°            Efficiency 87 %            Peak intensity 1.4 cd/lm            LEDs/each optic 1            Light colour White            Required components:            C13867_LENA-STD-BASE-VERO29            Bender Wirth: 431 Typ L3</p>	
<p></p> <p>LED V22 Gen7            FWHM / FWTM 51.0° / 67.0°            Efficiency 87 %            Peak intensity 1.4 cd/lm            LEDs/each optic 1            Light colour White            Required components:            C13867_LENA-STD-BASE-VERO29            C11996_LENA-LENS            Bender Wirth: 431 Typ L3</p>	
<p></p> <p>LED CXA/B 30xx            FWHM / FWTM 42.0° / 62.0°            Efficiency 86 %            Peak intensity 1.6 cd/lm            LEDs/each optic 1            Light colour White            Required components:            IDEAL: 50-2234C + 50-2100LN</p>	

### OPTICAL RESULTS (SIMULATED):



LED CXA/B 30xx  
FWHM / FWTM 43.0° / 64.0°  
Efficiency 81 %  
Peak intensity 1.5 cd/lm  
LEDs/each optic 1  
Light colour White  
Required components:  
C11996\_LENA-LENS  
IDEAL: 50-2234C + 50-2100LN

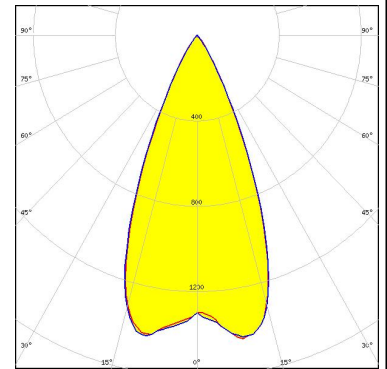

LED CxM-14 (19x19)  
FWHM / FWTM 47.0° / 67.0°  
Efficiency 81 %  
Peak intensity 1.3 cd/lm  
LEDs/each optic 1  
Light colour White  
Required components:  
C13868\_LENA-STD-BASE-VERO13-18  
C11996\_LENA-LENS  
Bender Wirth: 433 Typ L1



LED CxM-14 (19x19)  
FWHM / FWTM 47.0° / 61.0°  
Efficiency 86 %  
Peak intensity 1.6 cd/lm  
LEDs/each optic 1  
Light colour White  
Required components:  
C13868\_LENA-STD-BASE-VERO13-18  
Bender Wirth: 433 Typ L1



LED CxM-22 (28x28)  
FWHM / FWTM 48.0° / 62.0°  
Efficiency 83 %  
Peak intensity 1.5 cd/lm  
LEDs/each optic 1  
Light colour White  
Required components:  
C12692\_LENA-STD-BASE-CLL040

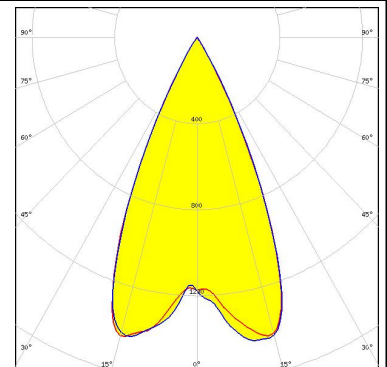

### OPTICAL RESULTS (SIMULATED):



LED CxM-9 (13.5x13.5)  
FWHM / FWTM 44.0° / 59.0°  
Efficiency 86 %  
Peak intensity 1.9 cd/lm  
LEDs/each optic 1  
Light colour White  
Required components:  
C13868\_LENA-STD-BASE-VERO13-18  
Bender Wirth: 434 Typ L1



LED CxM-9 (13.5x13.5)  
FWHM / FWTM 45.0° / 64.0°  
Efficiency 81 %  
Peak intensity 1.5 cd/lm  
LEDs/each optic 1  
Light colour White  
Required components:  
C13868\_LENA-STD-BASE-VERO13-18  
C11996\_LENA-LENS  
Bender Wirth: 434 Typ L1



Opto Semiconductors

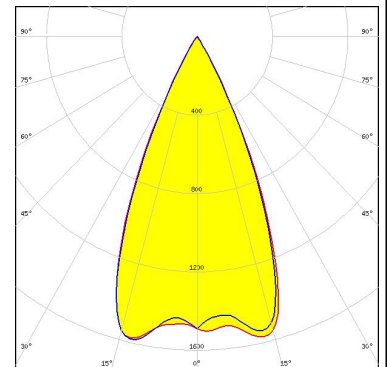

LED Soleriq S15  
FWHM / FWTM 48.0° / 61.0°  
Efficiency 88 %  
Peak intensity 1.6 cd/lm  
LEDs/each optic 1  
Light colour White  
Required components:  
C12691\_LENA-STD-BASE-CLL030



SEOUL SEMICONDUCTOR

LED ZC12/18  
FWHM / FWTM 47.0° / 61.0°  
Efficiency 86 %  
Peak intensity 1.6 cd/lm  
LEDs/each optic 1  
Light colour White  
Required components:  
C13868\_LENA-STD-BASE-VERO13-18  
Bender Wirth: 433 Typ L1

### OPTICAL RESULTS (SIMULATED):

	
SEOL SEMICONDUCTOR	
LED	ZC12/18
FWHM / FWTM	47.0° / 67.0°
Efficiency	81 %
Peak intensity	1.3 cd/lm
LEDs/each optic	1
Light colour	White
Required components:	
C13868_LENA-STD-BASE-VERO13-18	
C11996_LENA-LENS	
Bender Wirth: 433 Typ L1	
<hr/>	
	
SEOL SEMICONDUCTOR	
LED	ZC4/6
FWHM / FWTM	44.0° / 59.0°
Efficiency	86 %
Peak intensity	1.9 cd/lm
LEDs/each optic	1
Light colour	White
Required components:	
C13868_LENA-STD-BASE-VERO13-18	
Bender Wirth: 434 Typ L1	
<hr/>	
	
SEOL SEMICONDUCTOR	
LED	ZC4/6
FWHM / FWTM	45.0° / 64.0°
Efficiency	81 %
Peak intensity	1.5 cd/lm
LEDs/each optic	1
Light colour	White
Required components:	
C13868_LENA-STD-BASE-VERO13-18	
C11996_LENA-LENS	
Bender Wirth: 434 Typ L1	

### GENERAL INFORMATION:

NOTE: The typical beam angle will be changed by different color, chip size and chip position tolerance. The typical total beam angle is the full angle measured where the luminous intensity is half of the peak value.

Due to use of high power COB's with this product, special attention to proper thermal design is highly recommended. LEDiL has no liability for direct, indirect or consecutive damages arising from the LEDiL products being used outside of the recommended temperature range.

### MATERIALS:

As part of our continuous research and improvement processes, and to ensure the best possible quality and availability of our products, LEDiL reserves the right to change material grades without notice.

### PRODUCT DATA USER AGREEMENT AND DISCLAIMER:

The measured data in the provided downloadable LEDiL Product Datasheets and Mechanical 2D-Drawings is rounded and provided as reference for planning. LEDiL Oy's optical specifications have been verified by conducting performance testing of the products in accordance with the company's quality system. The reported data are averaged results of multiple measurements with typical variation. LEDiL Oy reserves the right to without prior notification make changes and improvements to its products.

LEDiL Oy assumes neither warranty, nor guarantee nor any other liability of any kind for the contents and correctness of the provided data. The provided data has been generated with highest diligence but the provided data may in reality not represent the complete possible variation range of all intrinsic parameters. Therefore, in certain cases a deviation from the provided data could occur.

LEDiL Oy reserves the right to undertake technical changes of its products without further notification which could lead to changes in the provided data. LEDiL Oy assumes no liability of any kind for the possible deviation from any provided data or any other damage resulting from the usage of the provided data.

The user agrees to this disclaimer and user agreement with the download or usage of the provided files.

#### LEDiL Oy

Joensuunkatu 13  
FI-24240 SALO  
Finland

#### LEDiL Inc.

228 West Page Street  
Suite D  
Sycamore IL 60178  
USA

#### Ledil Optics Technology (Shenzhen) Co., Ltd.

# 405 , Block B  
Casic Motor Building  
Shenzhen 518057  
P.R.CHINA

#### Local sales and technical support

[www.ledil.com/  
where\\_to\\_buy](http://www.ledil.com/where_to_buy)

#### Shipping locations

Salo, Finland  
Hong Kong, China

#### Distribution Partners

[www.ledil.com/  
where\\_to\\_buy](http://www.ledil.com/where_to_buy)