

## TINA3-W

~40° wide beam optimized for CREE XP-E.  
Assembly with holder, installation tape and  
location pins.

### SPECIFICATION:

Dimensions	Ø 16.1 mm
Height	7.3 mm
Fastening	tape, pin
ROHS compliant	yes ⓘ



### MATERIALS:

Component	Type	Material	Colour	Finish
TINA3-W	Single lens	PMMA	clear	
TINA3-HLD-PIN-TAPE-XP	Holder	PC	white	
TINA-TAPE3	Tape	Acrylic foam	black	

### ORDERING INFORMATION:

Component		Qty in box	MOQ	MPQ	Box weight (kg)
FA11902_TINA3-W	Single lens	2016	288	288	3.5
» Box size: 470 x 240 x 105 mm					

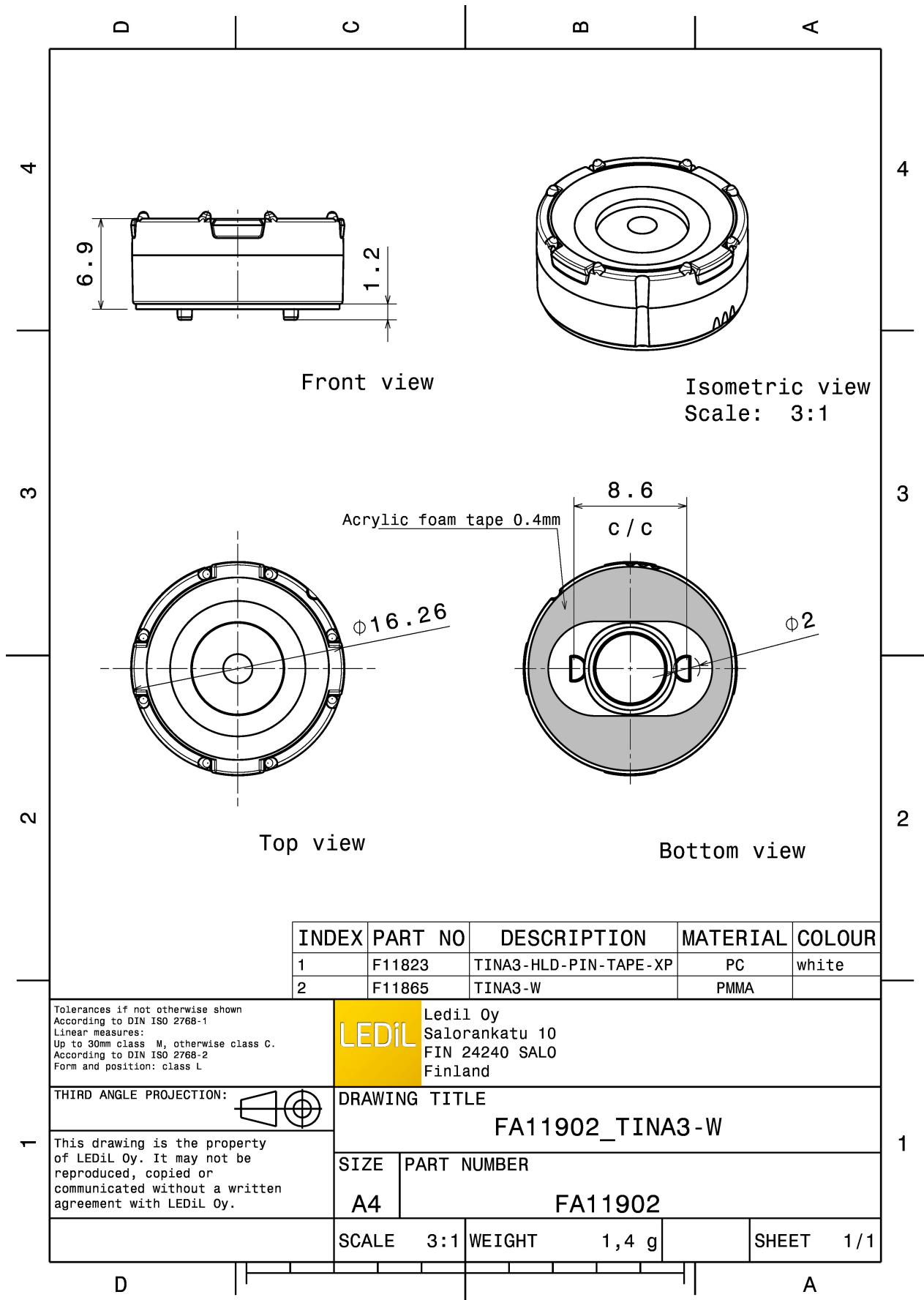

See also our general installation guide: [www.ledil.com/installation\\_guide](http://www.ledil.com/installation_guide)

#### OPTICAL RESULTS (MEASURED):



LED XM-L  
 FWHM / FWTM 43.0° / 82.0°  
 Efficiency 94 %  
 Peak intensity 1 cd/lm  
 LEDs/each optic 1  
 Light colour White  
 Required components:

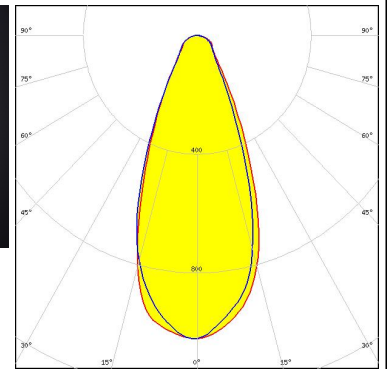
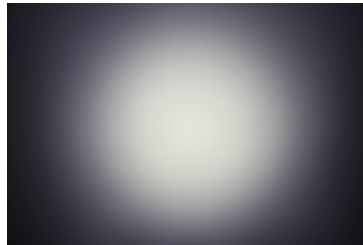

LED XM-L2  
 FWHM / FWTM 38.0° / 70.0°  
 Efficiency 91 %  
 LEDs/each optic 1  
 Light colour White  
 Required components:

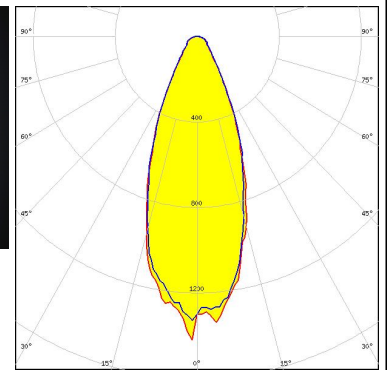
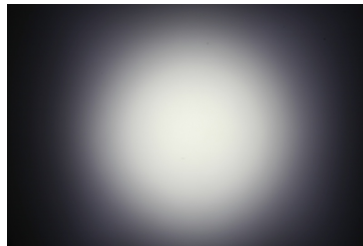

LED XP-G2  
 FWHM / FWTM 32.0° / 58.0°  
 Efficiency 89 %  
 Peak intensity 2 cd/lm  
 LEDs/each optic 1  
 Light colour White  
 Required components:

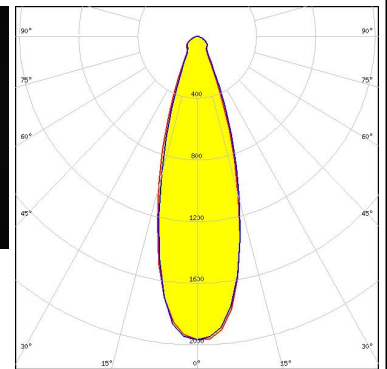
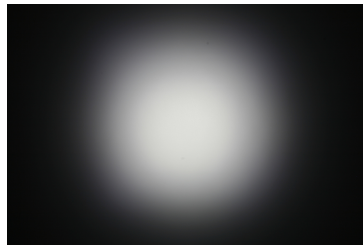

LED XP-L HD  
 FWHM / FWTM 34.0° / 68.0°  
 Efficiency 89 %  
 Peak intensity 1.6 cd/lm  
 LEDs/each optic 1  
 Light colour White  
 Required components:

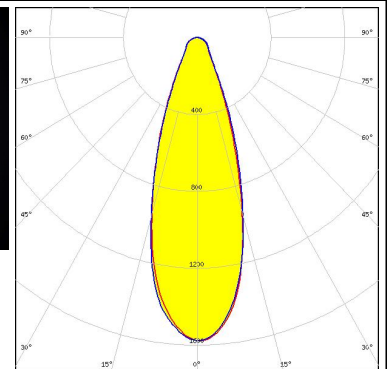
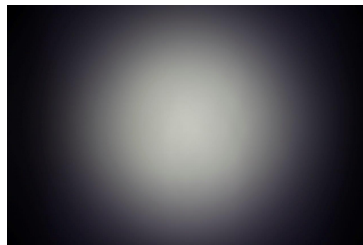

#### OPTICAL RESULTS (MEASURED):



LED XP-L HI  
 FWHM / FWTM 31.0° / 57.0°  
 Efficiency 91 %  
 Peak intensity 2 cd/lm  
 LEDs/each optic 1  
 Light colour White  
 Required components:

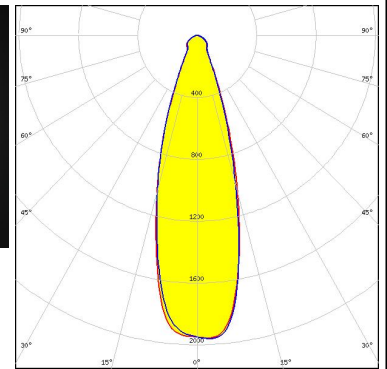
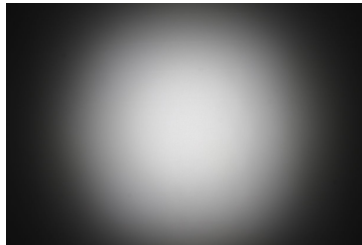

LED XT-E  
 FWHM / FWTM 30.0° / 57.0°  
 Efficiency 92 %  
 Peak intensity 2.3 cd/lm  
 LEDs/each optic 1  
 Light colour White  
 Required components:

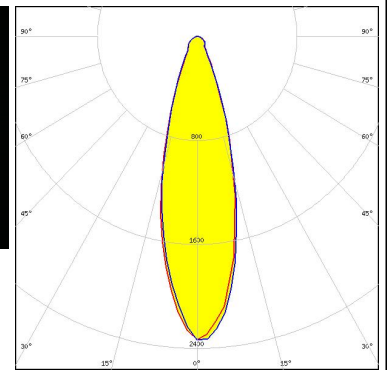
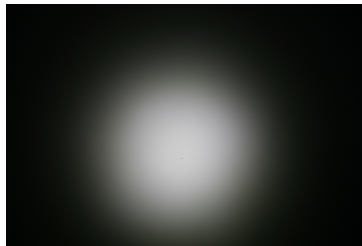

LED NS9x383  
 FWHM / FWTM 48.0° / 85.0°  
 Efficiency 90 %  
 Peak intensity 1.1 cd/lm  
 LEDs/each optic 1  
 Light colour White  
 Required components:

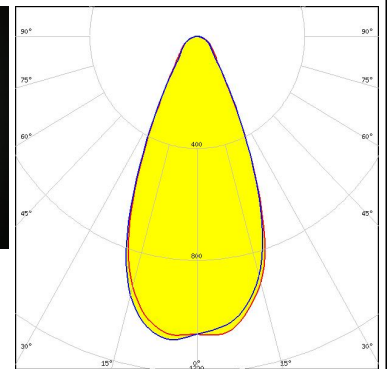
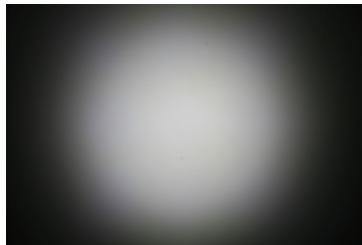

LED NVSU333A  
 FWHM / FWTM 30.0° / 60.0°  
 Efficiency 94 %  
 Peak intensity 1.9 cd/lm  
 LEDs/each optic 1  
 Light colour White  
 Required components:

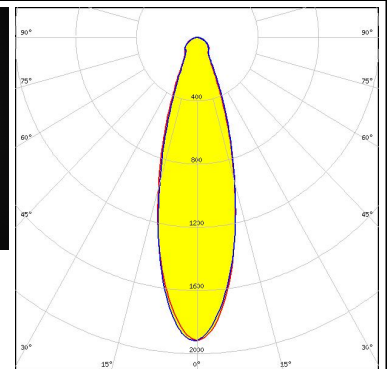
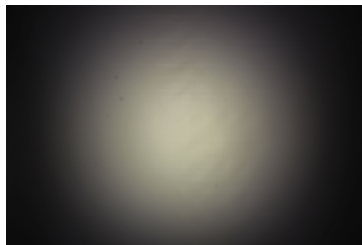

#### OPTICAL RESULTS (SIMULATED):



LED XD16  
 FWHM / FWTM 52.0° / 86.0°  
 Efficiency 90 %  
 Peak intensity 1 cd/lm  
 LEDs/each optic 4  
 Light colour White  
 Required components:

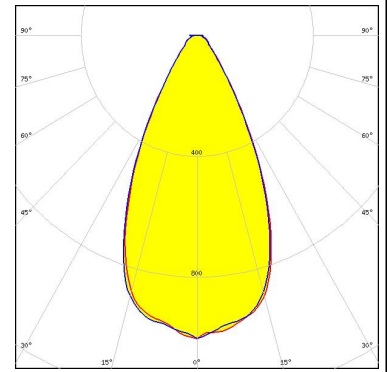

LED XHP35 HD  
 FWHM / FWTM 38.0° / 89.0°  
 Efficiency 90 %  
 Peak intensity 1.2 cd/lm  
 LEDs/each optic 1  
 Light colour White  
 Required components:

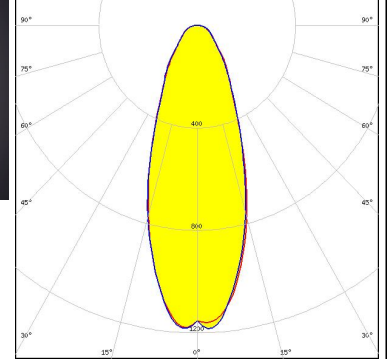
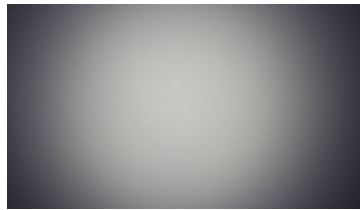

LED XHP35.2 HD  
 FWHM / FWTM 46.0° / 89.0°  
 Efficiency 86 %  
 Peak intensity 1.1 cd/lm  
 LEDs/each optic 1  
 Light colour White  
 Required components:

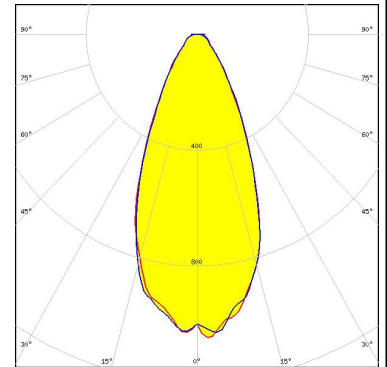

LED XM-L HVW  
 FWHM / FWTM 50.0°  
 Efficiency %  
 LEDs/each optic 1  
 Light colour White  
 Required components:

#### OPTICAL RESULTS (SIMULATED):



LED XP-E2  
 FWHM / FWTM 22.0° / 50.0°  
 Efficiency 96 %  
 Peak intensity 3 cd/lm  
 LEDs/each optic 1  
 Light colour White  
 Required components:

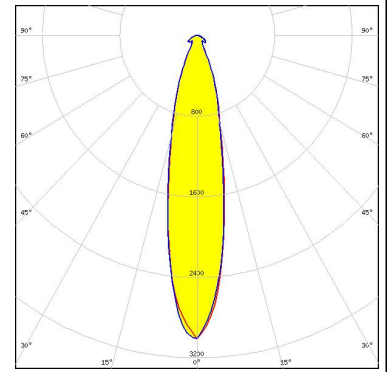

LED XP-G3  
 FWHM / FWTM 33.0° / 77.0°  
 Efficiency 90 %  
 Peak intensity 1.5 cd/lm  
 LEDs/each optic 1  
 Light colour White  
 Required components:

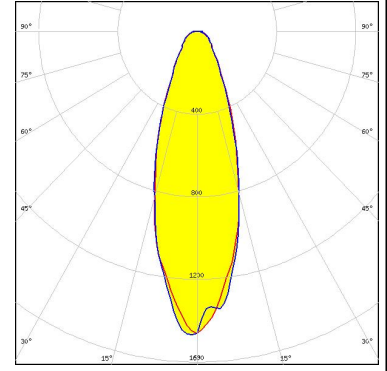

LED LUXEON HL2X  
 FWHM / FWTM 38.0° / 67.0°  
 Efficiency 92 %  
 Peak intensity 1.5 cd/lm  
 LEDs/each optic 1  
 Light colour White  
 Required components:

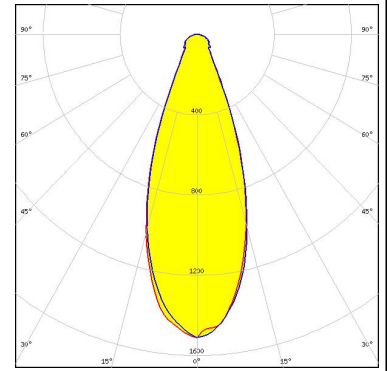

LED NVSW3x9A  
 FWHM / FWTM 40.0° / 70.0°  
 Efficiency 91 %  
 Peak intensity 1.4 cd/lm  
 LEDs/each optic 1  
 Light colour White  
 Required components:

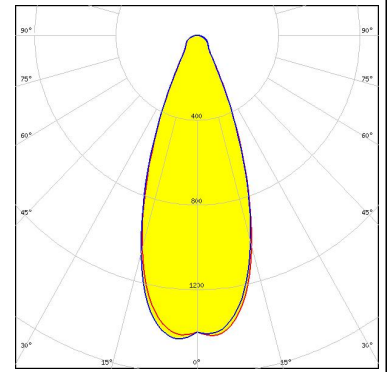

#### OPTICAL RESULTS (SIMULATED):

##### OSRAM

Opto Semiconductors

LED OSLON Signal  
 FWHM / FWTM 24.0° / 52.0°  
 Efficiency 90 %  
 Peak intensity 2.9 cd/lm  
 LEDs/each optic 1  
 Light colour Blue  
 Required components:

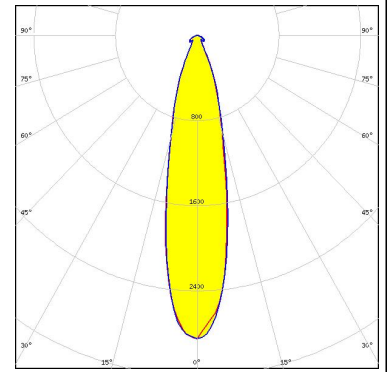

##### OSRAM

Opto Semiconductors

LED OSLON SSL 80  
 FWHM / FWTM 31.0° / 56.0°  
 Efficiency 90 %  
 Peak intensity 1.9 cd/lm  
 LEDs/each optic 1  
 Light colour Far Red  
 Required components:

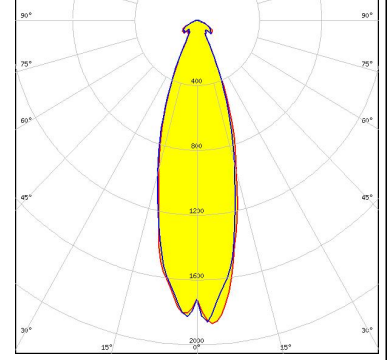

##### OSRAM

Opto Semiconductors

LED OSLON SSL 80  
 FWHM / FWTM 30.0° / 57.0°  
 Efficiency 94 %  
 Peak intensity 2 cd/lm  
 LEDs/each optic 1  
 Light colour White  
 Required components:

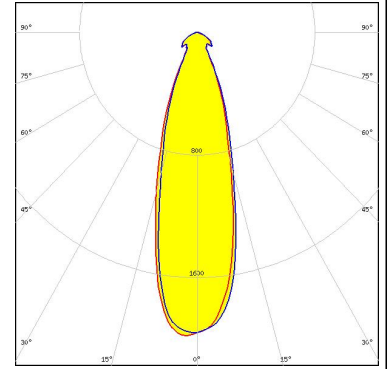

### GENERAL INFORMATION:

NOTE: The typical beam angle will be changed by different color, chip size and chip position tolerance. The typical total beam angle is the full angle measured where the luminous intensity is half of the peak value.

### MATERIALS:

As part of our continuous research and improvement processes, and to ensure the best possible quality and availability of our products, LEDiL reserves the right to change material grades without notice.

### PRODUCT DATA USER AGREEMENT AND DISCLAIMER:

The measured data in the provided downloadable LEDiL Product Datasheets and Mechanical 2D-Drawings is rounded and provided as reference for planning. LEDiL Oy's optical specifications have been verified by conducting performance testing of the products in accordance with the company's quality system. The reported data are averaged results of multiple measurements with typical variation. LEDiL Oy reserves the right to without prior notification make changes and improvements to its products.

LEDiL Oy assumes neither warranty, nor guarantee nor any other liability of any kind for the contents and correctness of the provided data. The provided data has been generated with highest diligence but the provided data may in reality not represent the complete possible variation range of all intrinsic parameters. Therefore, in certain cases a deviation from the provided data could occur.

LEDiL Oy reserves the right to undertake technical changes of its products without further notification which could lead to changes in the provided data. LEDiL Oy assumes no liability of any kind for the possible deviation from any provided data or any other damage resulting from the usage of the provided data.

The user agrees to this disclaimer and user agreement with the download or usage of the provided files.

#### LEDiL Oy

Joensuunkatu 13  
FI-24240 SALO  
Finland

#### LEDiL Inc.

228 West Page Street  
Suite D  
Sycamore IL 60178  
USA

#### Ledil Optics Technology (Shenzhen) Co., Ltd.

# 405 , Block B  
Casic Motor Building  
Shenzhen 518057  
P.R.CHINA

#### Local sales and technical support

[www.ledil.com/  
where\\_to\\_buy](http://www.ledil.com/where_to_buy)

#### Shipping locations

Salo, Finland  
Hong Kong, China

#### Distribution Partners

[www.ledil.com/  
where\\_to\\_buy](http://www.ledil.com/where_to_buy)