



**Pb-free  
HEAT**



# 1154LDS Series

PLCC-2 Type White LED  
(High Reliability type, White V-Series)

## Features

Package	PLCC-2 Type, Diffused pale yellow resin
Product features	<ul style="list-style-type: none"> <li>• Outer Dimension 3.5 x 2.8 x 1.9mm( L x W x H )</li> <li>• Wide operation temperature range. Storage Temperature : -40°C~120°C Operating Temperature : -40°C~100°C Operation Guarantee</li> <li>• Spatial distribution characteristics. (2θ 1/2 : 120deg)</li> <li>• Corresponding to a use requiring high reliability in cars etc...</li> <li>• Lead-free soldering compatible</li> <li>• RoHS compliant</li> </ul>
Chromaticity coordinates	TYP. x = 0.285, y = 0.299
Color temperature	TYP. 9,000K
Spatial distribution	120 deg.
Die materials	InGaN
Optical efficiency	VSEW : 64lm/W VCMW : 23lm/W VCPW : 20lm/W
Rank grouping parameter	Sorted by luminous intensity and chromaticity per rank taping
Assembly method	Auto pick & place machine (Auto Mounter)
Soldering methods	Reflow soldering / Manual Soldering
Taping and reel	2,000pcs per reel in a 8mm width tape. (Standard) Reel diameter: 180mm
ESD	Up to 1kV (HBM)

## Recommended Applications

SW lighting for car indicators, meter panel, car audio and heater control, etc...



# 1154LDS Series

PLCC-2 Type White LED  
(High Reliability type, White V-Series)

## Color and Luminous Intensity

(Ta=25°C)

Part No.	Material	Emitted Color	Lens Color	Luminous Intensity			Luminous Flux	
				I <sub>v</sub> (mcd)			φ <sub>v</sub> (lm)	
				MIN.	TYP.	I <sub>F</sub> (mA)	TYP.	I <sub>F</sub> (mA)
VSEW1154LDS-E	InGaN	White	Pale Yellow	1,800	2,300	30	6.5	30
VCMW1154LDS			Pale Yellow	560	820	30	2.3	30
VCPW1154LDS			Pale Yellow	120	220	10	0.62	10

※Note : The above luminous intensity(I<sub>v</sub>) is the setup values of the sorting machine.  
(Tolerance : I<sub>v</sub>... ±10%)

## Absolute Maximum Ratings

(Ta=25°C)

Item	Symbol	Absolute Maximum Ratings			Unit
		VSEW	VCMW	VCPW	
Power Dissipation	$P_d$	117	120	76	mW
Continuous Forward Current	$I_F$	30	30	20	mA
Repetitive Peak Forward Current <sup>※1</sup>	$I_{FRM}$	100	100	100	mA
Derating (Ta=85°C or higher)	$\Delta I_F$	0.86	0.86	0.57	mA/°C
	$\Delta I_{FRM}$	2.86	2.86	2.86	mA/°C
Reverse Voltage	$V_R$	-	5	5	V
Allowable Reverse Current	$I_R$	85	-	-	mA
Operating Temperature	$T_{opr}$	-40~+100			°C
Storage Temperature	$T_{stg}$	-40~+120			°C

※1  $I_{FRM}$  Measurement condition / VSEW : Pulse Width  $\leq 10ms$ , Duty  $\leq 1/10$   
VCMW, VCPW : Pulse Width  $\leq 0.1ms$ , Duty  $\leq 1/10$

## Thermal Characteristics

Item	Symbol	Ratings			Unit
		VSEW	VCMW	VCPW	
Junction Temperature (MAX.)	$T_j$	120	120	120	°C
Thermal Resistance (TYP.) (Junction/ ambient)	$R_{(th\ j-a)}$	250	270	300	°C/W
Thermal Resistance (TYP.) (Junction/ Solder Point)	$R_{(th\ j-s)}$	100	120	150	°C/W

※Rth(j-a) Measurement Condition / Substrate: FR4(t=1.6mm) Pattern Size: 16mm<sup>2</sup>.



# 1154LDS Series

PLCC-2 Type White LED  
(High Reliability type, White V-Series)

## Electro-Optical Characteristics (VSEW/VCMW)

(Ta=25°C)

Item	Condition	Symbol	Characteristics		Unit	
			VSEW	VCMW		
Forward Voltage	I <sub>F</sub> =30mA	V <sub>F</sub>	TYP.	3.4	3.3	V
			MAX.	3.9	4.0	
Reverse Current	V <sub>R</sub> =5V	I <sub>R</sub>	MAX.	-	10	μA
Reverse Voltage	I <sub>R</sub> =85mA	V <sub>R</sub>	MAX.	1.7	-	V
Half Intensity Angle	I <sub>F</sub> =30mA	2θ <sub>1/2</sub>	TYP.	120		deg.
Chromaticity Coordinates	I <sub>F</sub> =30mA	x	TYP.	0.285		-
		y	TYP.	0.299		-

## Electro-Optical Characteristics (VCPW)

(Ta=25°C)

Item	Condition	Symbol	Characteristics		Unit
			VCPW		
Forward Voltage	I <sub>F</sub> =10mA	V <sub>F</sub>	TYP.	3.1	V
			MAX.	3.7	
Reverse Current	V <sub>R</sub> =5V	I <sub>R</sub>	MAX.	10	μA
Half Intensity Angle	I <sub>F</sub> =10mA	2θ <sub>1/2</sub>	TYP.	120	deg.
Chromaticity Coordinates	I <sub>F</sub> =10mA	x	TYP.	0.285	-
		y	TYP.	0.299	-

## Luminous Intensity Rank

(Ta=25°C)

Intensity Tolerance each Rank : +/-10%

Rank	I <sub>v</sub> (mcd)											
	VSEW		VCMW		VCPW							
	I <sub>F</sub> =30mA		I <sub>F</sub> =30mA		I <sub>F</sub> =10mA							
	MIN.	MAX.	MIN.	MAX.	MIN.	MAX.						
C2	/	/	/	/	120	150						
C3					150	180						
C4					180	220						
C5					220	270						
C6					270	330						
C7					/	/	/	/	/	/		
C8												
C9												
CX											560	680
CY											680	820
CZ											820	1,000
D1					1,000	1,200						
D2					/	/	/	/	/	/		
D3												
D4	1,800	2,200										
D5	2,200	2,700										
D6	2,700	3,300										

※ Please contact our sales staff concerning rank designation.

## Sorting Chart for Chromaticity Coordinates

(Ta=25°C)

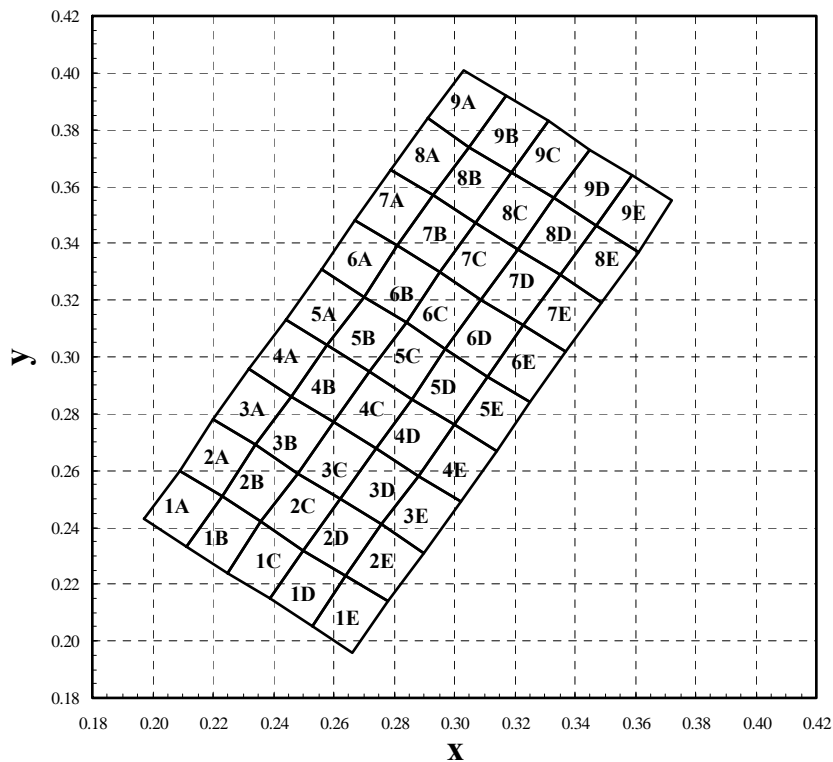
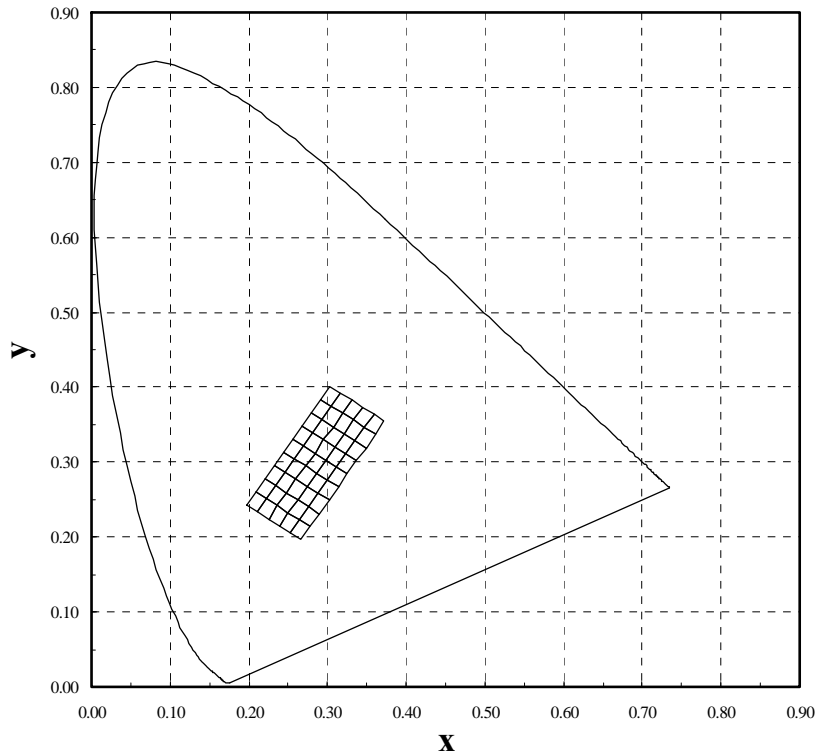

## Sorting Chart for Chromaticity Coordinates

(Ta=25°C)

Chromaticity Coordinates Tolerance Each Rank : +/-0.01

Rank	Left Down Point		Left Upper Point		Right Upper Point		Right Down Point	
	x	y	x	y	x	y	x	y
1A	0.197	0.243	0.209	0.260	0.223	0.251	0.211	0.233
1B	0.211	0.233	0.223	0.251	0.236	0.242	0.225	0.224
1C	0.225	0.224	0.236	0.242	0.250	0.232	0.239	0.215
1D	0.239	0.215	0.250	0.232	0.264	0.223	0.253	0.205
1E	0.253	0.205	0.264	0.223	0.278	0.214	0.266	0.196
2A	0.209	0.260	0.220	0.278	0.234	0.269	0.223	0.251
2B	0.223	0.251	0.234	0.269	0.248	0.259	0.236	0.242
2C	0.236	0.242	0.248	0.259	0.262	0.250	0.250	0.232
2D	0.250	0.232	0.262	0.250	0.276	0.241	0.264	0.223
2E	0.264	0.223	0.276	0.241	0.290	0.231	0.278	0.214
3A	0.220	0.278	0.232	0.296	0.246	0.286	0.234	0.269
3B	0.234	0.269	0.246	0.286	0.260	0.277	0.248	0.259
3C	0.248	0.259	0.260	0.277	0.274	0.268	0.262	0.250
3D	0.262	0.250	0.274	0.268	0.288	0.258	0.276	0.241
3E	0.276	0.241	0.288	0.258	0.302	0.249	0.290	0.231
4A	0.232	0.296	0.244	0.313	0.258	0.304	0.246	0.286
4B	0.246	0.286	0.258	0.304	0.272	0.295	0.260	0.277
4C	0.260	0.277	0.272	0.295	0.286	0.285	0.274	0.268
4D	0.274	0.268	0.286	0.285	0.300	0.276	0.288	0.258
4E	0.288	0.258	0.300	0.276	0.314	0.267	0.302	0.249
5A	0.244	0.313	0.256	0.331	0.270	0.321	0.258	0.304
5B	0.258	0.304	0.270	0.321	0.284	0.312	0.272	0.295
5C	0.272	0.295	0.284	0.312	0.297	0.303	0.286	0.285
5D	0.286	0.285	0.297	0.303	0.311	0.293	0.300	0.276
5E	0.300	0.276	0.311	0.293	0.325	0.284	0.314	0.267
6A	0.256	0.331	0.267	0.348	0.281	0.339	0.270	0.321
6B	0.270	0.321	0.281	0.339	0.295	0.330	0.284	0.312
6C	0.284	0.312	0.295	0.330	0.309	0.320	0.297	0.303
6D	0.297	0.303	0.309	0.320	0.323	0.311	0.311	0.293
6E	0.311	0.293	0.323	0.311	0.337	0.302	0.325	0.284
7A	0.267	0.348	0.279	0.366	0.293	0.357	0.281	0.339
7B	0.281	0.339	0.293	0.357	0.307	0.347	0.295	0.330
7C	0.295	0.330	0.307	0.347	0.321	0.338	0.309	0.320
7D	0.309	0.320	0.321	0.338	0.335	0.329	0.323	0.311
7E	0.323	0.311	0.335	0.329	0.349	0.319	0.337	0.302
8A	0.279	0.366	0.291	0.384	0.305	0.374	0.293	0.357
8B	0.293	0.357	0.305	0.374	0.319	0.365	0.307	0.347
8C	0.307	0.347	0.319	0.365	0.333	0.356	0.321	0.338
8D	0.321	0.338	0.333	0.356	0.347	0.346	0.335	0.329
8E	0.335	0.329	0.347	0.346	0.361	0.337	0.349	0.319
9A	0.291	0.384	0.303	0.401	0.317	0.392	0.305	0.374
9B	0.305	0.374	0.317	0.392	0.331	0.383	0.319	0.365
9C	0.319	0.365	0.331	0.383	0.345	0.373	0.333	0.356
9D	0.333	0.356	0.345	0.373	0.359	0.364	0.347	0.346
9E	0.347	0.346	0.359	0.364	0.372	0.355	0.361	0.337

※Please contact our sales staff concerning rank designation.

## Technical Data (VSEW)

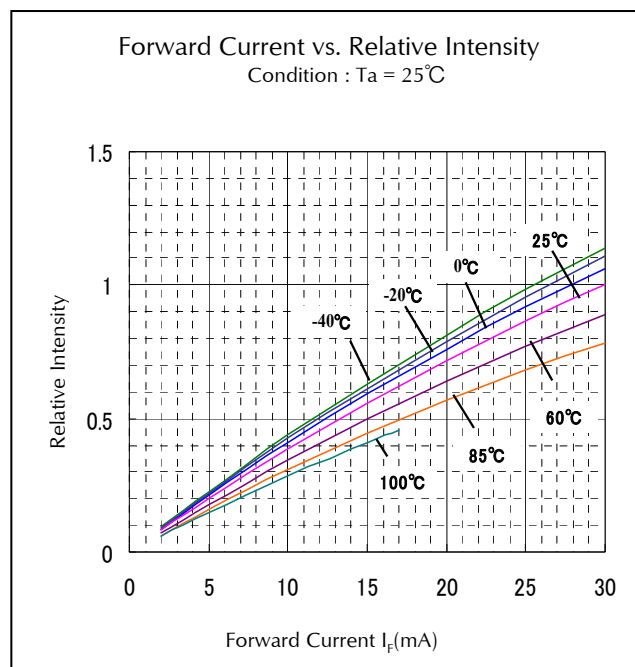
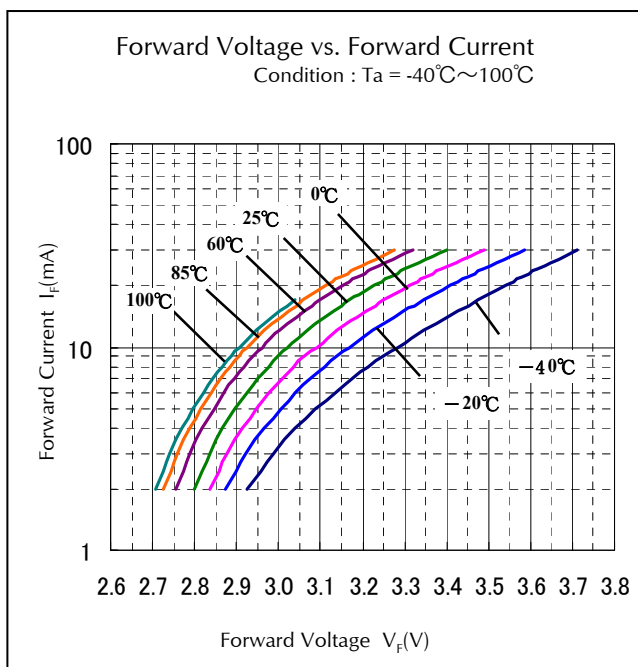
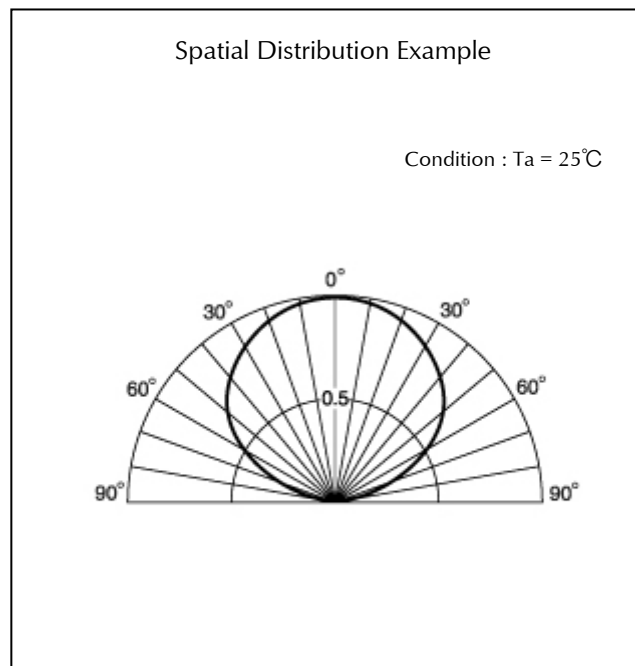
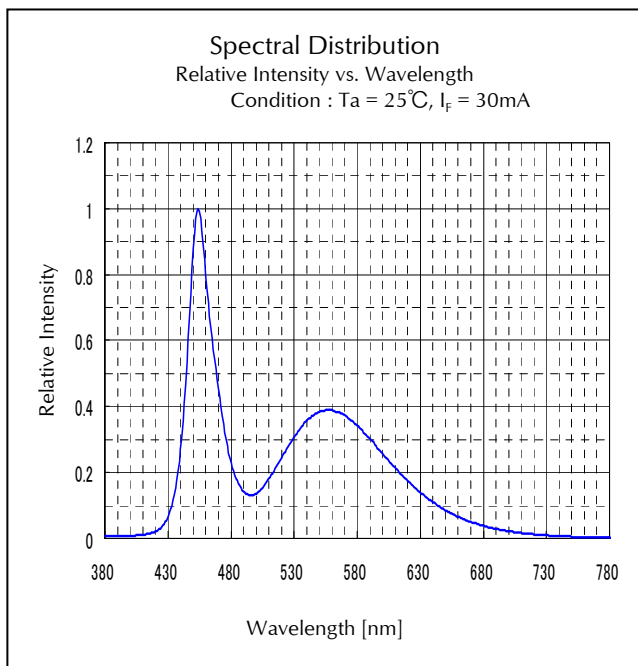



## Technical Data (VSEW)

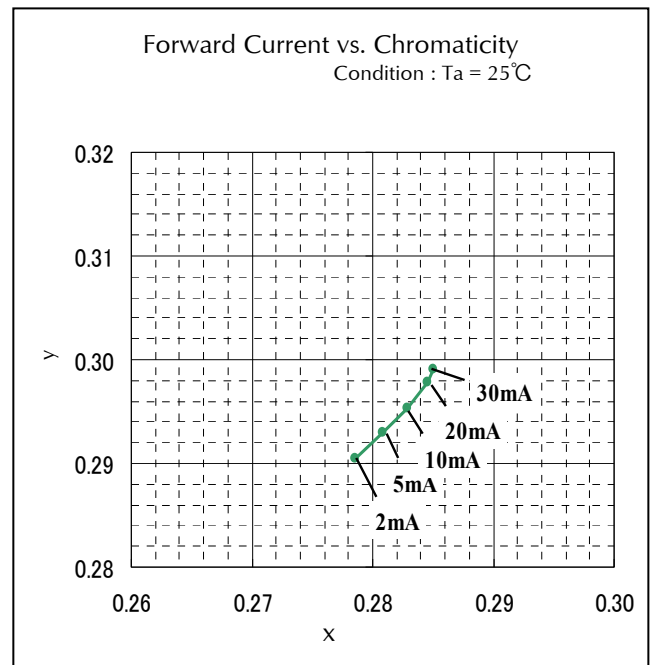
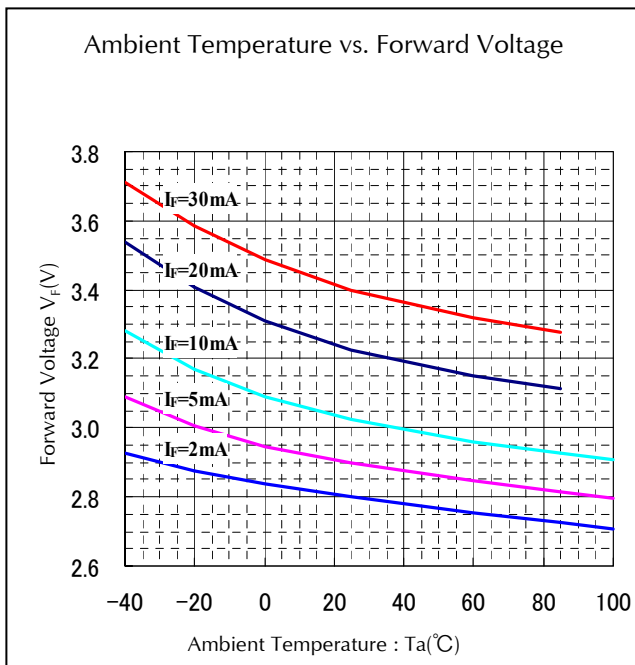
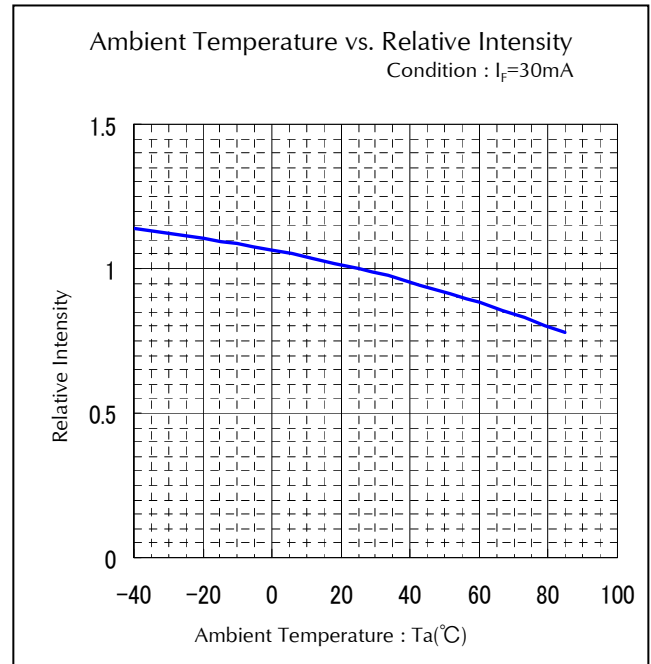
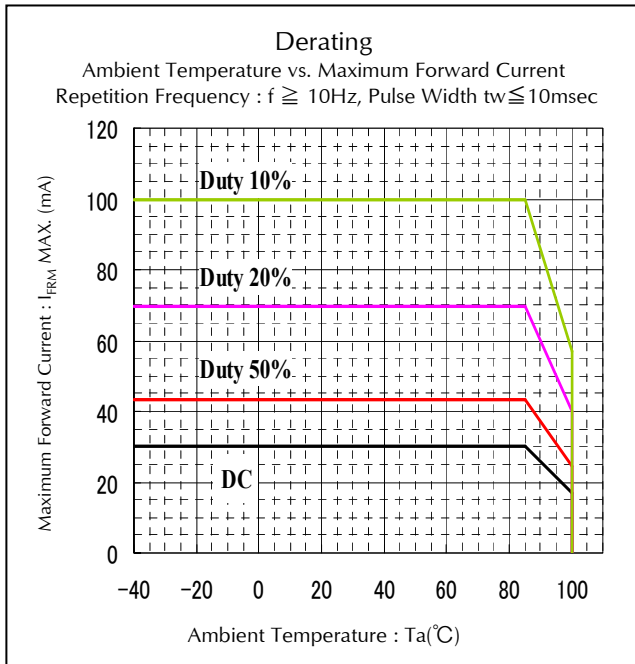

## Technical Data (VSEW)

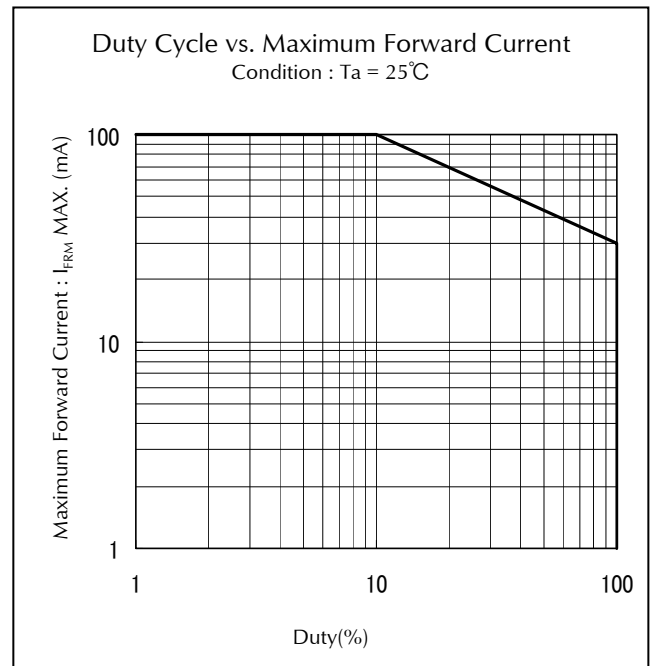
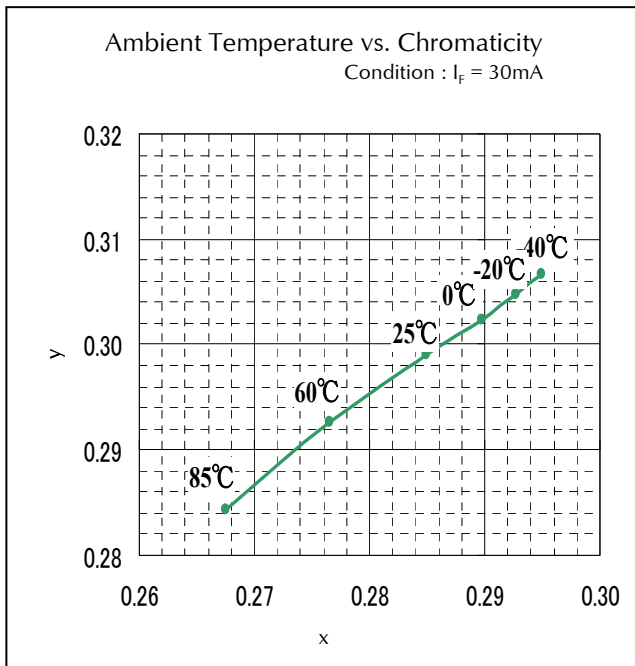

## Technical Data (VCMW)

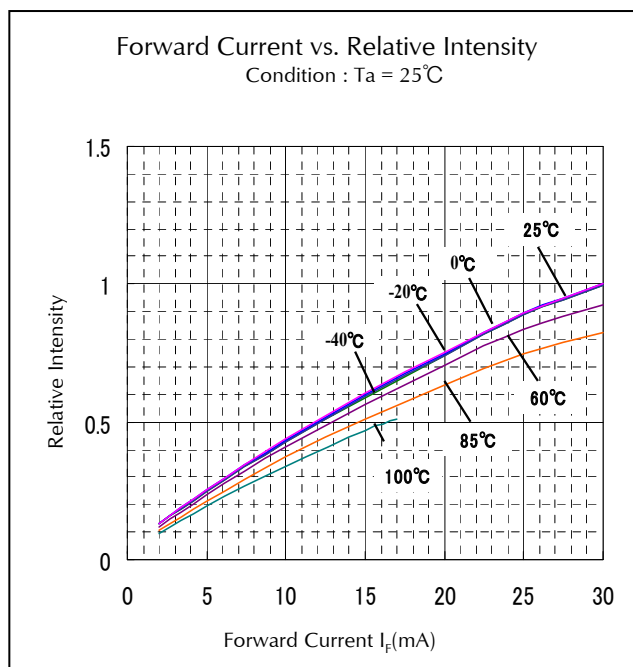
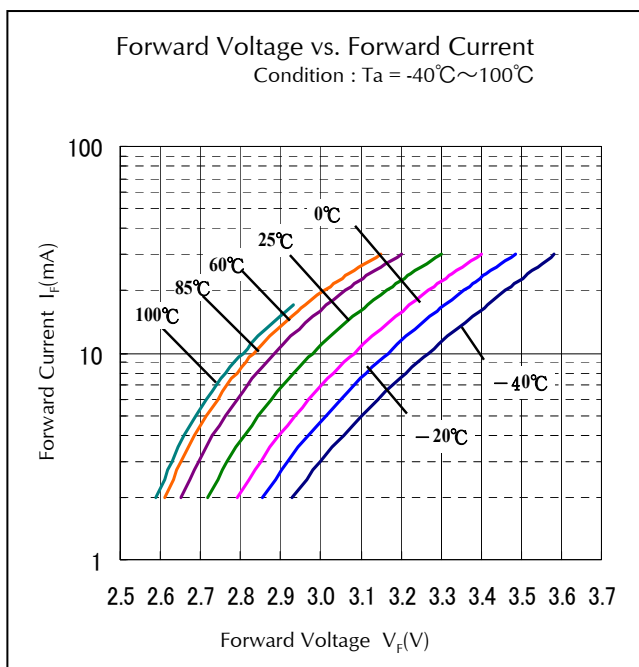
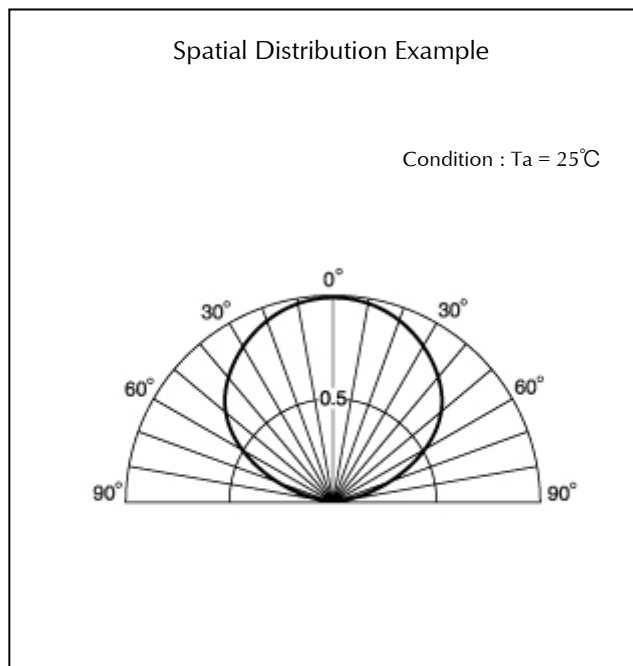
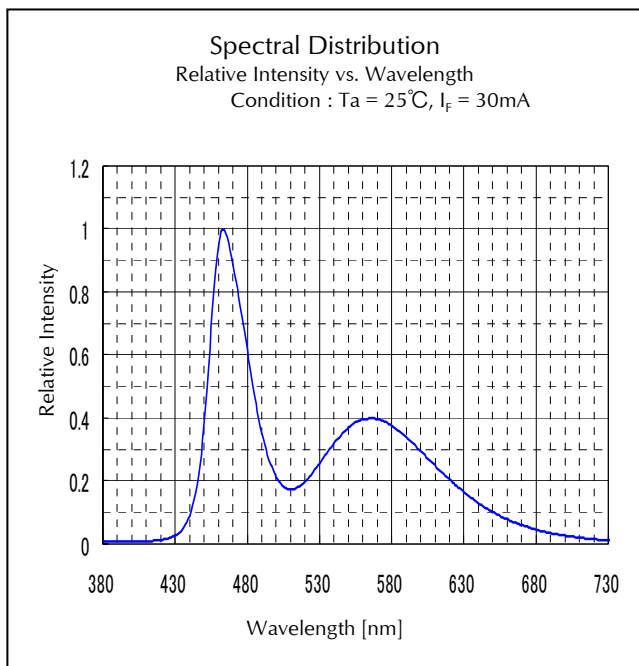

## Technical Data (VCMW)

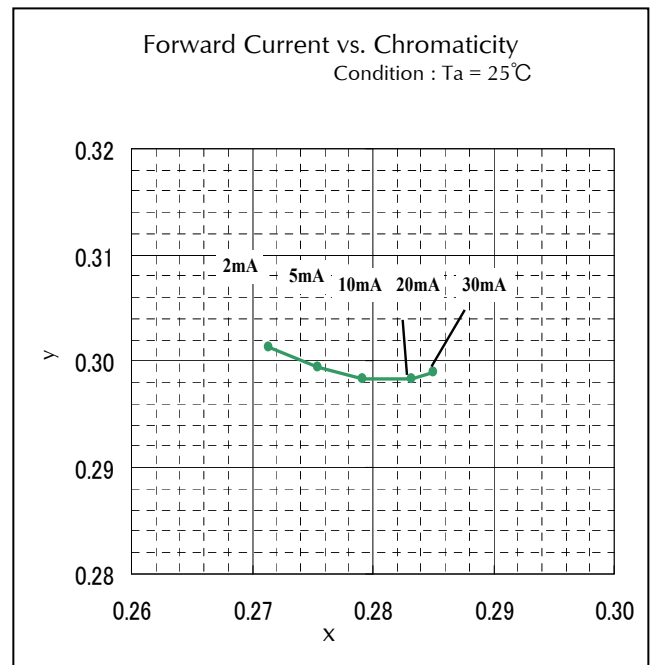
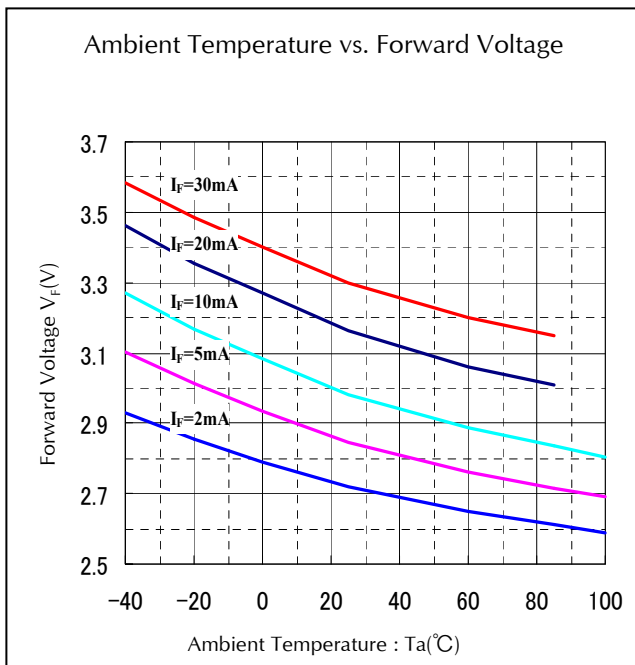
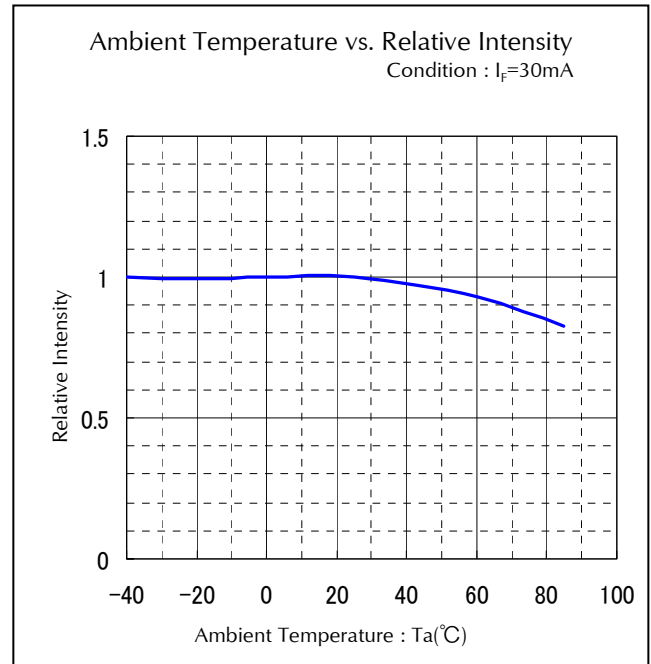
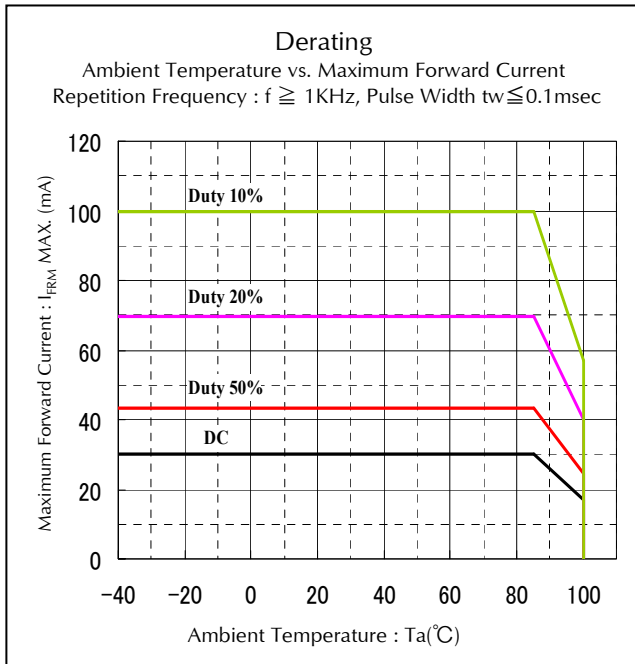

## Technical Data (VCMW)

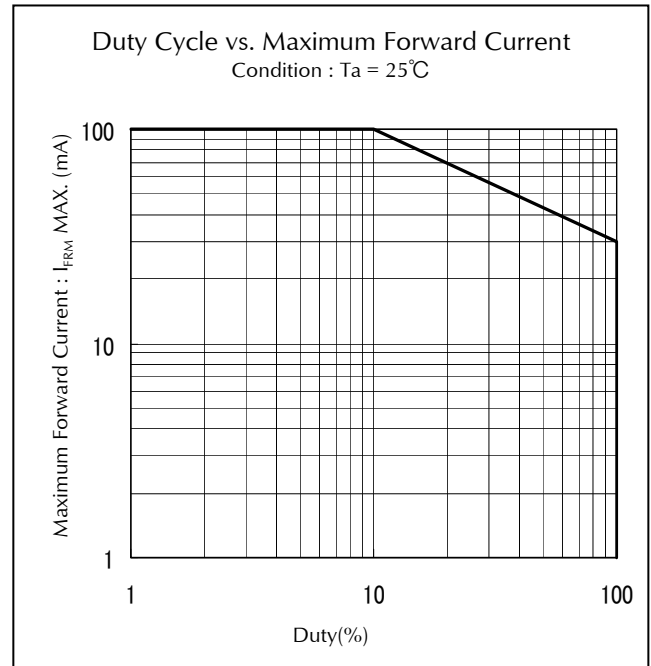
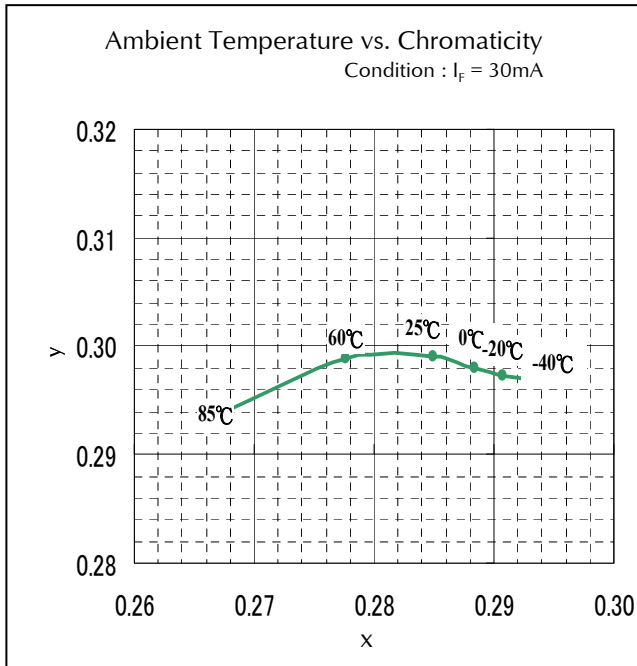

## Technical Data (VCPW)

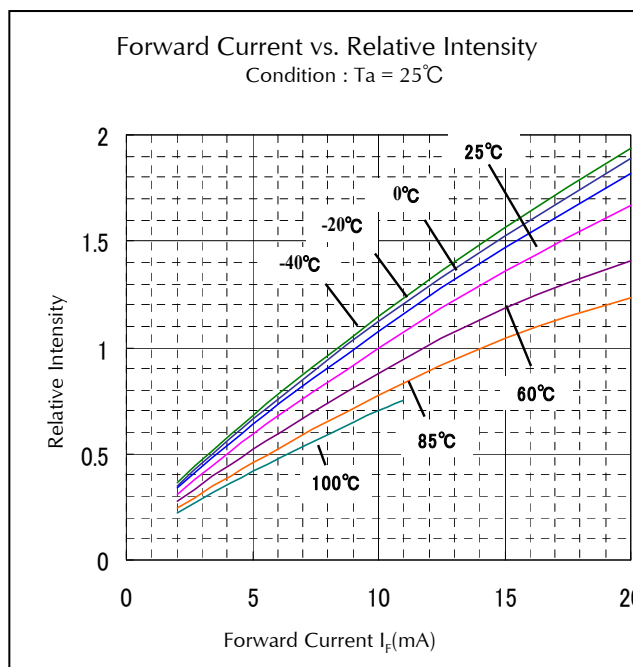
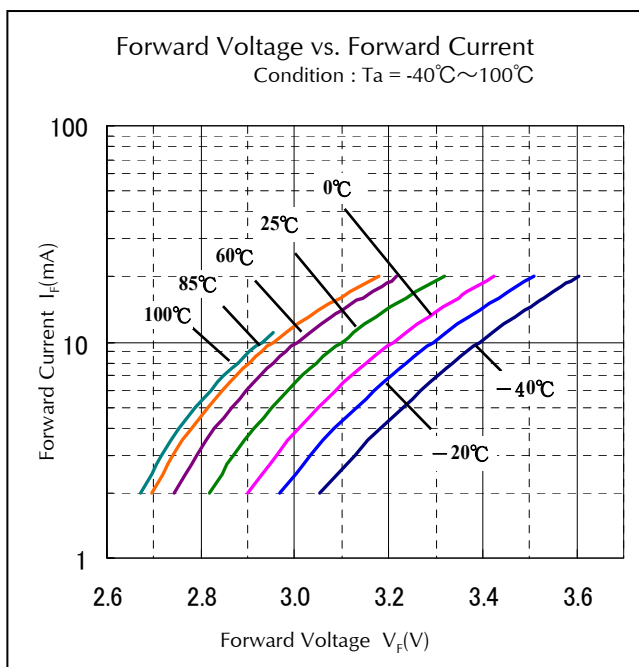
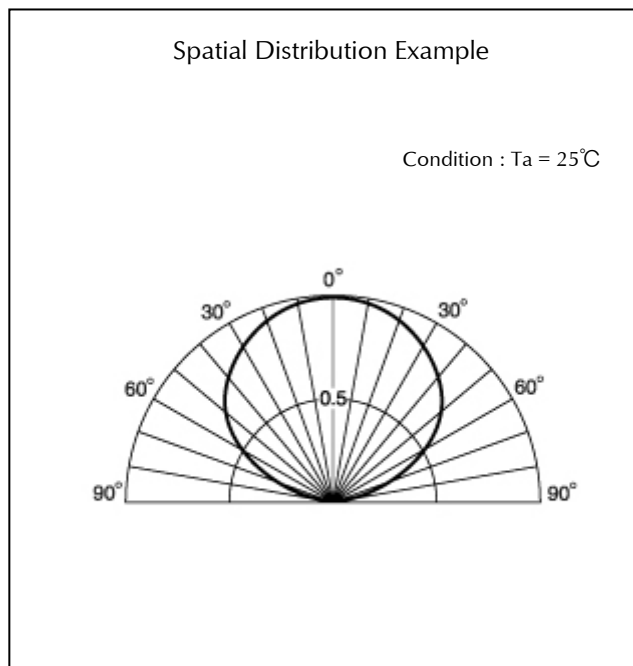
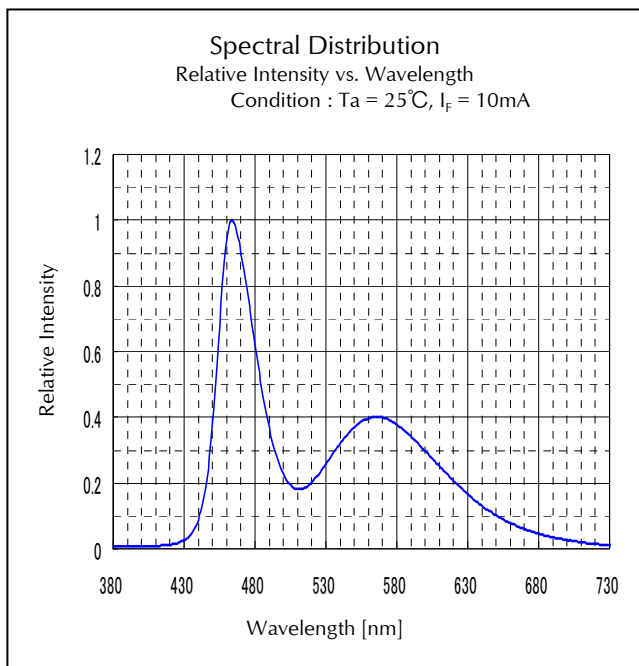

## Technical Data (VCPW)

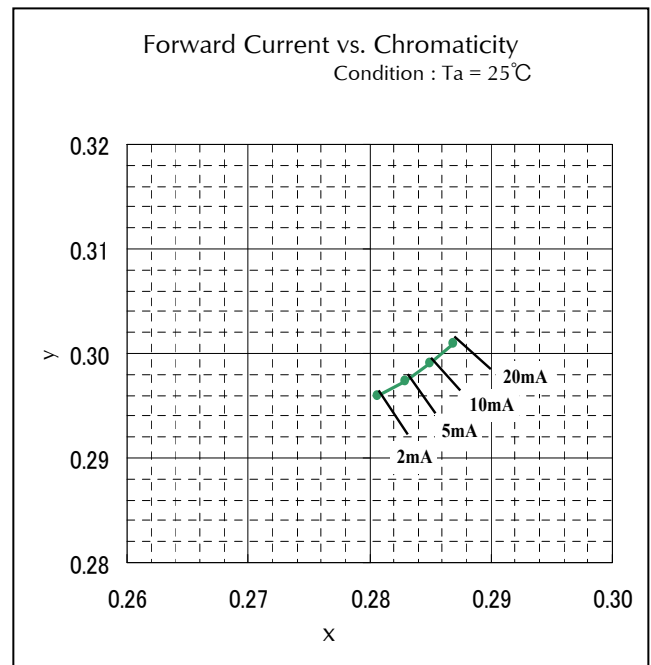
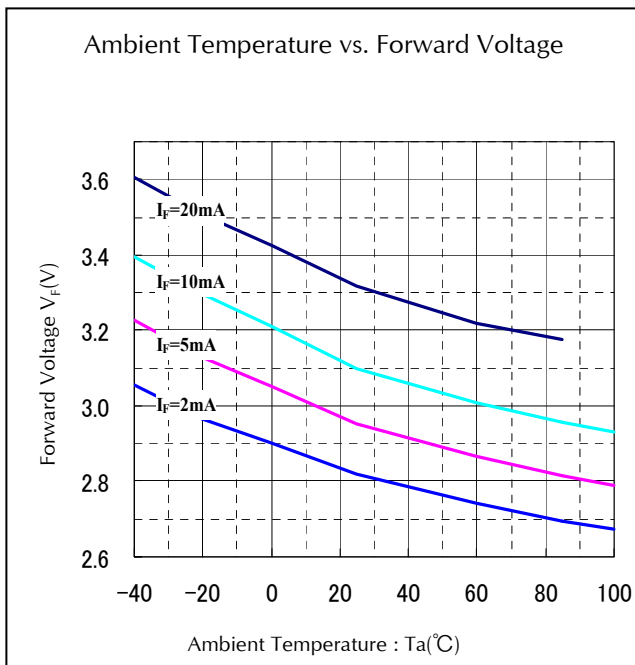
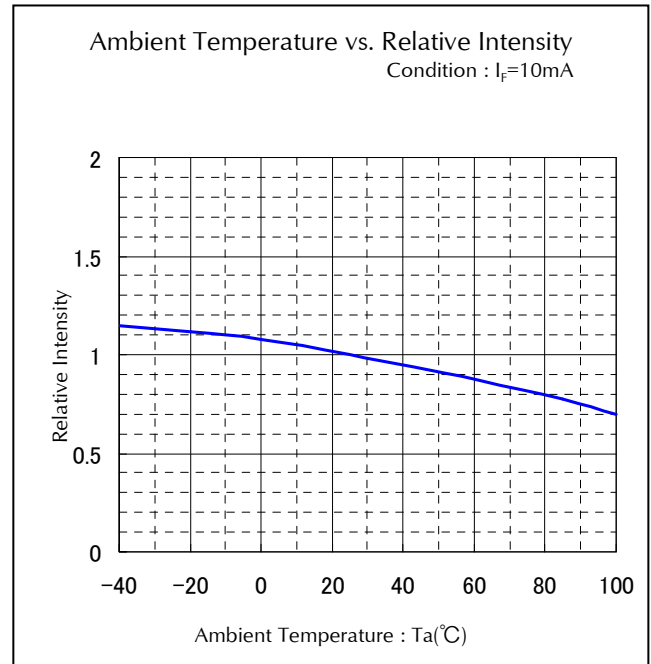
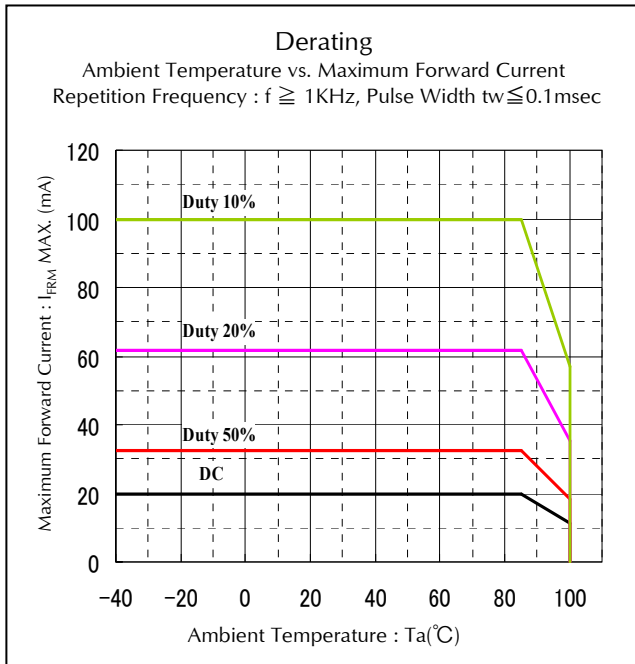

## Technical Data (VCPW)

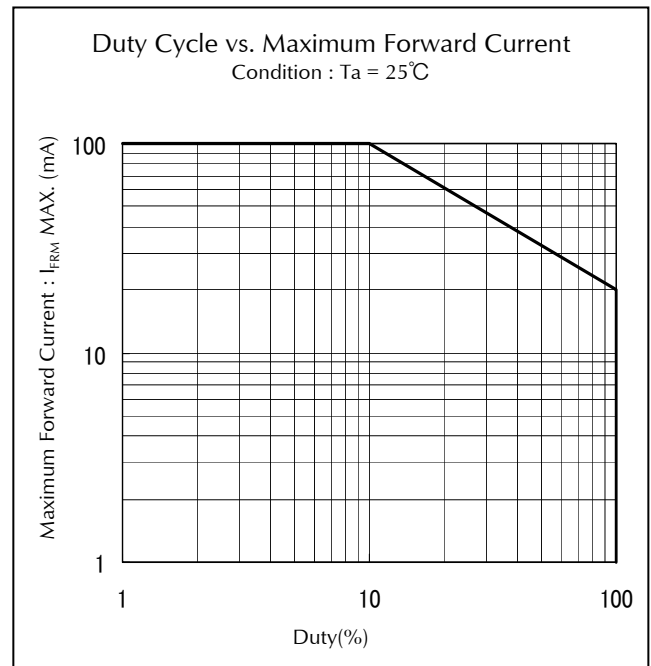
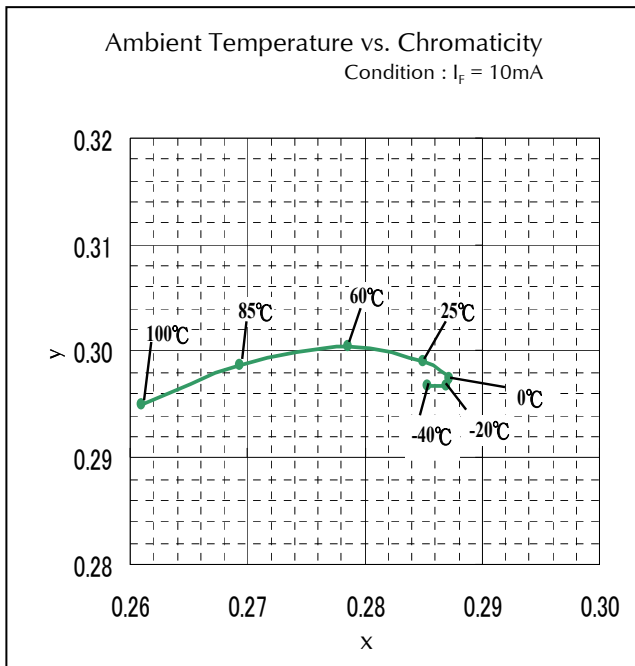





## Reflow Soldering Conditions

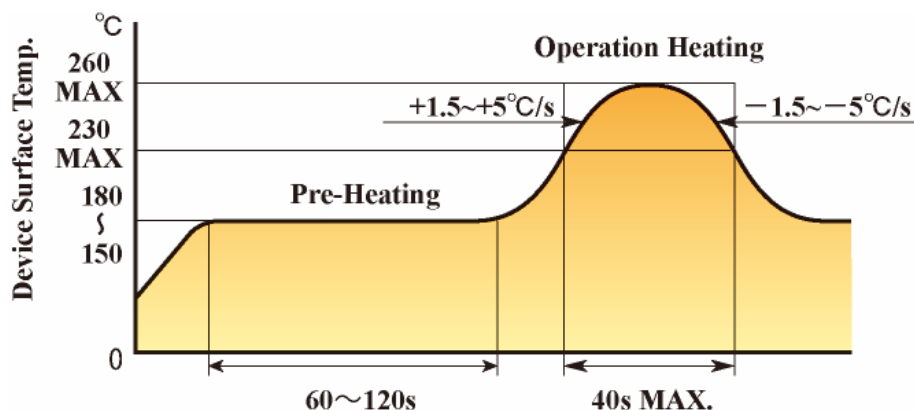

- 1) The above profile temperature gives the maximum temperature of the LED resin surface. Please set the temperature so as to avoid exceeding this range.
- 2) Total times of reflow soldering process shall be no more than 2 times. When the second reflow soldering process is performed, intervals between the first and second reflow should be short as possible (while allowing some time for the component to return to room temperature after the first reflow) in order to prevent the LED resin from absorbing moisture.
- 3) Temperature fluctuation to the LED during the pre-heating process shall be minimized.

## Manual Soldering Conditions

Iron tip temp.	350 °C	(MAX.)
Soldering time and frequency	3 s	(MAX.)
	1 time	(MAX.)

## Reliability Testing Result

Reliability Testing Result	Applicable Standard	Testing Conditions	Duration	Failure
Room Temp. Operating Life	EIAJ ED-4701/100(101)	Ta = 25°C, I <sub>F</sub> = Maximum Rated Current	1,000 h	0/20
High Temp. Operating Life	EIAJ ED-4701/100(101)	Ta = 85°C, I <sub>F</sub> = Maximum Rated Current	1,000 h	0/20
Low Temp. Operating Life	EIAJ ED-4701/100(101)	Ta = -40°C, I <sub>F</sub> = Maximum Rated Current	1,000 h	0/20
Wet High Temp. Operating Life	EIAJ ED-4701/100(102)	Ta = 60°C, 90%, I <sub>F</sub> = Maximum Rated Current	1,000 h	0/20
Wet High Temp. Storage Life	EIAJ ED-4701/100(103)	Ta = 60°C, 90%	1,000 h	0/20
Thermal Shock	EIAJ ED-4701/100(105)	Ta = -40°C ~ 120°C (each 15min.)	1,000 cycles	0/20
Thermal Shock Operating	EIAJ ED-4701/100(105)	Ta = -40°C(OFF) ~ 85°C (I <sub>F</sub> = Maximum Rated Current ON) (each 15min.)	1,000 cycles	0/20
High Temp. Storage Life	EIAJ ED-4701/200(201)	Ta = 120°C	1,000 h	0/20
Low Temp. Storage Life	EIAJ ED-4701/200(202)	Ta = -40°C	1,000 h	0/20
Cycled Temp. Humidity Operating Life	EIAJ ED-4701/200(203)	Ta = -30°C(2h) ~ 80°C, 95%(2h), 8h/cycle I <sub>F</sub> = Maximum Rated Current 5min on-off	30 cycles	0/20
Resistance to Reflow Soldering	EIAJ ED-4701/300(301)	Moisture Soak : 30°C, 70%, 672h Preheat : 150°C~180°C (120s Max.) Soldering Temp. : 260°C (5s)	Twice	0/20
Electric Static Dis charge (ESD) <sup>※1</sup>	EIAJ ED-4701/300(304)	C = 100pF, R <sub>2</sub> = 1.5KΩ, ±2,000V	once each polarity	0/10
Vibration, Variable Frequency	EIAJ ED-4701/400(403)	98.1m/s <sup>2</sup> (10G), 100 ~ 2KHz, 20min. XYZ each direction	2 h	0/10

※1 Reference test

## Failure Criteria

Items	Symbols	Conditions	Failure criteria
Luminous Intensity	I <sub>v</sub>	I <sub>F</sub> Value of each product Luminous Intensity	Testing Min. Value < Spec. Min. Value x 0.5
Forward Voltage	V <sub>F</sub>	I <sub>F</sub> Value of each product Forward Voltage	Testing Max. Value ≥ Spec. Max. Value x 1.2
Reverse Current (VCLW,VCMW,VCPW)	I <sub>R</sub>	V <sub>R</sub> = Maximum Rated Reverse Voltage V	Testing Max. Value ≥ Spec. Max. Value x 2.5
Cosmetic Appearance	-	-	Occurrence of notable decoloration, deformation and cracking

## Special Notice to Customers Using the Products and Technical Information Shown in This Data Sheet

- 1) The technical information shown in the data sheets are limited to the typical characteristics and circuit examples of the referenced products. It does not constitute the warranting of industrial property nor the granting of any license.
- 2) For the purpose of product improvement, the specifications, characteristics and technical data described in the data sheets are subject to change without prior notice. Therefore it is recommended that the most updated specifications be used in your design.
- 3) When using the products described in the data sheets, please adhere to the maximum ratings for operating voltage, heat dissipation characteristics, and other precautions for use. We are not responsible for any damage which may occur if these specifications are exceeded.
- 4) The products that have been described to this catalog are manufactured so that they will be used for the electrical instrument of the benchmark (OA equipment, telecommunications equipment, AV machine, home appliance and measuring instrument).  
The application of aircrafts, space borne application, transportation equipment, medical equipment and nuclear power control equipment, etc. needs a high reliability and safety, and the breakdown and the wrong operation might influence the life or the human body. Please consult us beforehand if you plan to use our product for the usages of aircrafts, space borne application, transportation equipment, medical equipment and nuclear power control equipment, etc. except OA equipment, telecommunications equipment, AV machine, home appliance and measuring instrument.
- 5) In order to export the products or technologies described in this data sheet which are under the "Foreign Exchange and Foreign Trade Control Law," it is necessary to first obtain an export permit from the Japanese government.
- 6) No part of this data sheet may be reprinted or reproduced without prior written permission from Stanley Electric Co., Ltd.
- 7) The most updated edition of this data sheet can be obtained from the address below:  
<http://www.stanley-components.com>