

TINA-D

~16° diffused spot beam. Assembly with holder, installation tape and location pins.

SPECIFICATION:

Dimensions	Ø 16.1 mm
Height	9.5 mm
Fastening	tape, pin
ROHS compliant	yes ⓘ



MATERIALS:

Component	Type	Material	Colour	Finish
TINA-D	Single lens	PMMA	clear	
TINA-HLD-PIN-BLK	Holder	PC	black	
TINA-TAPE3	Tape	Acrylic foam	black	

ORDERING INFORMATION:

Component		Qty in box	MOQ	MPQ	Box weight (kg)
FA11205_TINA-D	Single lens	2016	288	144	4.1
» Box size:					

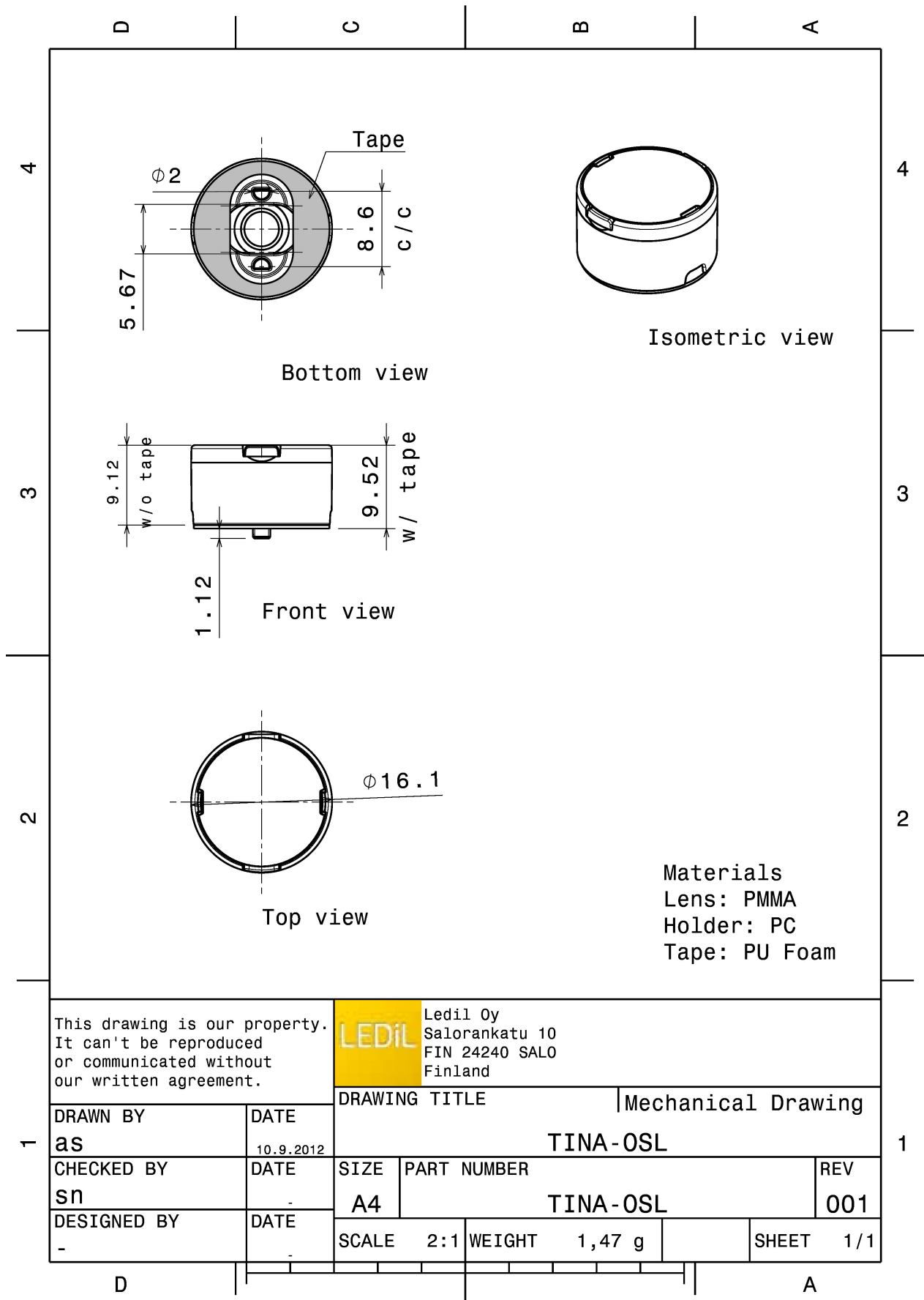

This drawing is our property. It can't be reproduced or communicated without our written agreement.		LEDiL LediL Oy Salorankatu 10 FIN 24240 SALO Finland	
DRAWN BY as		DRAWING TITLE Mechanical Drawing TINA-OSL	
CHECKED BY sn	DATE 10.9.2012	SIZE A4	PART NUMBER TINA-OSL REV 001
DESIGNED BY -	DATE -	SCALE 2:1	WEIGHT 1,47 g SHEET 1/1

See also our general installation guide: www.ledil.com/installation_guide

OPTICAL RESULTS (MEASURED):



LED XB-H
 FWHM / FWTM 17.0° / 35.0°
 Efficiency 87 %
 Peak intensity 7.3 cd/lm
 LEDs/each optic 1
 Light colour White
 Required components:

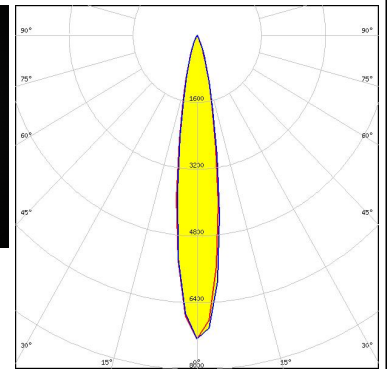
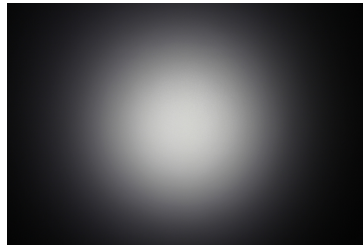

LED NVSW3x9A
 FWHM / FWTM 21.0° / 42.0°
 Efficiency 87 %
 Peak intensity 4.8 cd/lm
 LEDs/each optic 1
 Light colour White
 Required components:

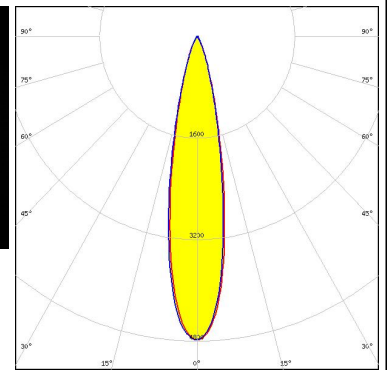

LED OSLOM SSL 150
 FWHM / FWTM 14.0° / 32.0°
 Efficiency 89 %
 Peak intensity 6.7 cd/lm
 LEDs/each optic 1
 Light colour White
 Required components:



LED OSLOM SSL 80
 FWHM / FWTM 12.0° / 28.0°
 Efficiency 89 %
 Peak intensity 10.1 cd/lm
 LEDs/each optic 1
 Light colour White
 Required components:

OPTICAL RESULTS (MEASURED):

SAMSUNG

LED LH351A
 FWHM / FWTM 18.0° / 37.0°
 Efficiency 93 %
 Peak intensity 4.1 cd/lm
 LEDs/each optic 1
 Light colour White
 Required components:



SEOUL SEMICONDUCTOR
 LED Z5M1/Z5M2
 FWHM / FWTM 16.0° / 33.0°
 Efficiency 90 %
 Peak intensity 7.9 cd/lm
 LEDs/each optic 1
 Light colour White
 Required components:

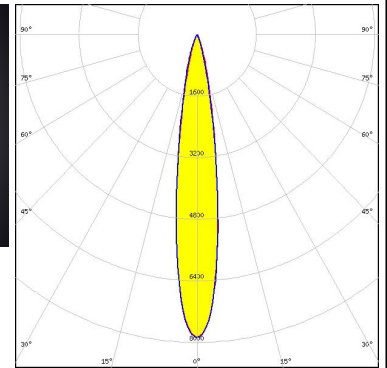
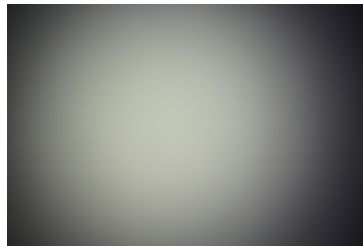

SEOUL SEMICONDUCTOR
 LED Z8Y22P
 FWHM / FWTM 19.0° / 40.0°
 Efficiency 85 %
 Peak intensity 5 cd/lm
 LEDs/each optic 1
 Light colour White
 Required components:

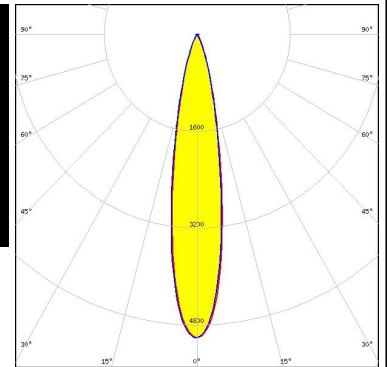
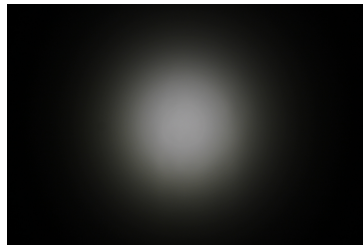

OPTICAL RESULTS (SIMULATED):

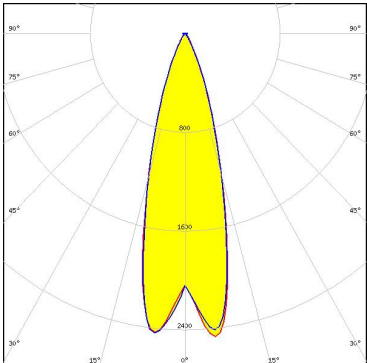
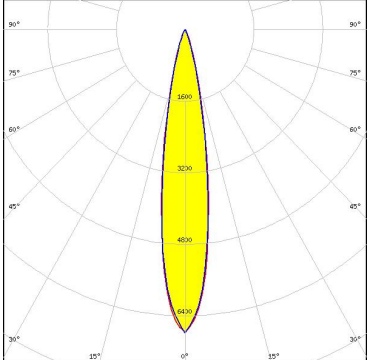
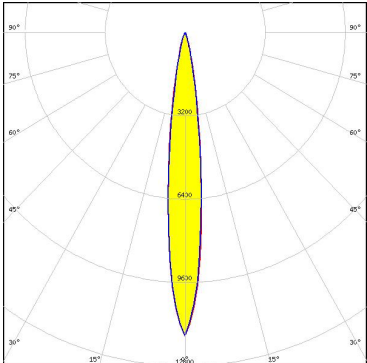
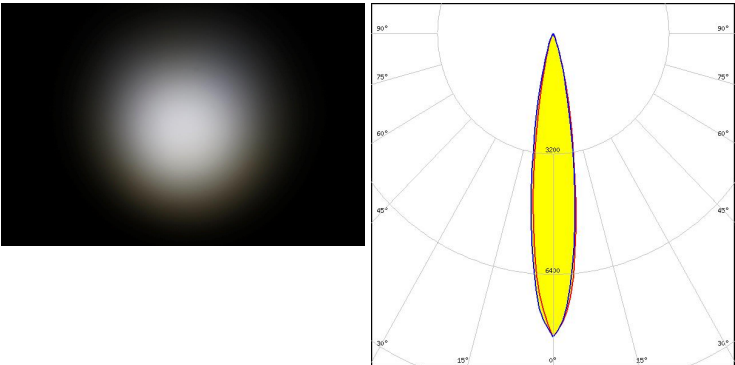
<p>NICHIA</p> <p>LED: NCSxE17A FWHM / FWTM: 30.0° / 52.0° Efficiency: 85 % Peak intensity: 2.5 cd/lm LEDs/each optic: 4 Light colour: White Required components:</p>	
<p>NICHIA</p> <p>LED: NVSxx19B/NVSxx19C FWHM / FWTM: 18.0° Efficiency: 88 % Peak intensity: 7 cd/lm LEDs/each optic: 1 Light colour: White Required components:</p>	
<p>OSRAM Opto Semiconductors</p> <p>LED: Duris E 2835 FWHM / FWTM: 13.0° / 28.0° Efficiency: 92 % Peak intensity: 11.7 cd/lm LEDs/each optic: 1 Light colour: White Required components:</p>	
<p>OSRAM Opto Semiconductors</p> <p>LED: Duris S5 (2 chip) FWHM / FWTM: 17.0° / 33.0° Efficiency: 92 % Peak intensity: 8.1 cd/lm LEDs/each optic: 1 Light colour: White Required components:</p>	

OPTICAL RESULTS (SIMULATED):

OSRAM
Opto Semiconductors

LED	SYNIOS S2222
FWHM / FWTM	12.0 + 11.0° / 22.0°
Efficiency	97 %
Peak intensity	17.9 cd/lm
LEDs/each optic	1
Light colour	White
Required components:	

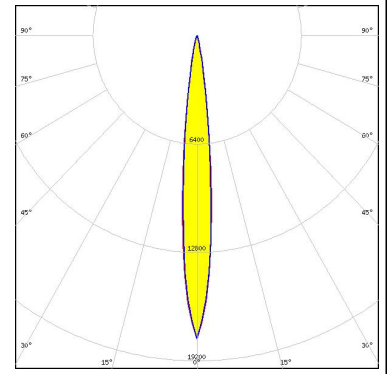

GENERAL INFORMATION:

NOTE: The typical beam angle will be changed by different color, chip size and chip position tolerance. The typical total beam angle is the full angle measured where the luminous intensity is half of the peak value.

MATERIALS:

As part of our continuous research and improvement processes, and to ensure the best possible quality and availability of our products, LEDiL reserves the right to change material grades without notice.

PRODUCT DATA USER AGREEMENT AND DISCLAIMER:

The measured data in the provided downloadable LEDiL Product Datasheets and Mechanical 2D-Drawings is rounded and provided as reference for planning. LEDiL Oy's optical specifications have been verified by conducting performance testing of the products in accordance with the company's quality system. The reported data are averaged results of multiple measurements with typical variation. LEDiL Oy reserves the right to without prior notification make changes and improvements to its products.

LEDiL Oy assumes neither warranty, nor guarantee nor any other liability of any kind for the contents and correctness of the provided data. The provided data has been generated with highest diligence but the provided data may in reality not represent the complete possible variation range of all intrinsic parameters. Therefore, in certain cases a deviation from the provided data could occur.

LEDiL Oy reserves the right to undertake technical changes of its products without further notification which could lead to changes in the provided data. LEDiL Oy assumes no liability of any kind for the possible deviation from any provided data or any other damage resulting from the usage of the provided data.

The user agrees to this disclaimer and user agreement with the download or usage of the provided files.

LEDiL Oy

Joensuunkatu 13
FI-24240 SALO
Finland

LEDiL Inc.

228 West Page Street
Suite D
Sycamore IL 60178
USA

Ledil Optics Technology (Shenzhen) Co., Ltd.

405 , Block B
Casic Motor Building
Shenzhen 518057
P.R.CHINA

Local sales and technical support

[www.ledil.com/
where_to_buy](http://www.ledil.com/where_to_buy)

Shipping locations

Salo, Finland
Hong Kong, China

Distribution Partners

[www.ledil.com/
where_to_buy](http://www.ledil.com/where_to_buy)