

TINA2-M

~30° medium beam optimized for Nichia NCSxx19. Assembly with holder, installation tape and location pins.

SPECIFICATION:

Dimensions	Ø 16.1 mm
Height	9.3 mm
Fastening	tape, pin
ROHS compliant	yes ⓘ



MATERIALS:

Component	Type	Material	Colour	Finish
TINA2-XP-M	Single lens	PMMA	clear	
TINA2-HLD-NCS19-BLK	Holder	PC	black	
TINA-TAPE3	Tape	Acrylic foam	black	

ORDERING INFORMATION:

Component		Qty in box	MOQ	MPQ	Box weight (kg)
CA11021_TINA2-M	Single lens	4140	0	230	0.0
» Box size: 451 x 241 x 298 mm					

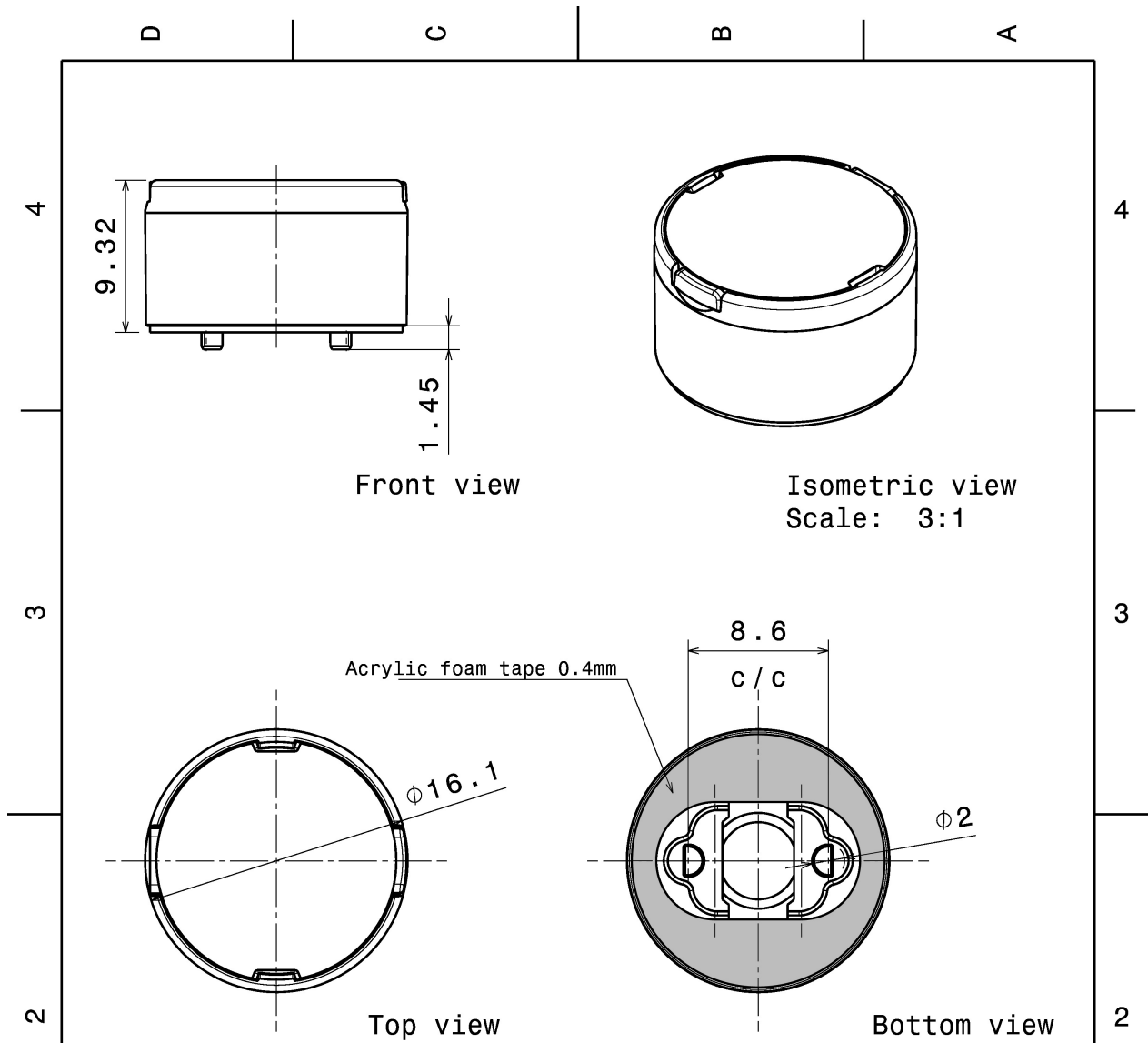

INDEX	PART NO	DESCRIPTION	MATERIAL	COLOUR
1	-	TINA2-lens	PMMA	clear
2	C11010	TINA2-HLD-NCS19-BLK	PC	black

Tolerances if not otherwise shown
According to DIN ISO 2768-1
Linear measures:
Up to 30mm class M, otherwise class C.
According to DIN ISO 2768-2
Form and position: class L

LEDiL Ledil Oy
Salorankatu 10
FIN 24240 SALO
Finland

THIRD ANGLE PROJECTION:

DRAWING TITLE
TINA2-NCS19 series

This drawing is the property of LEDiL Oy. It may not be reproduced, copied or communicated without a written agreement with LEDiL Oy.

SIZE	PART NUMBER
A4	-

SCALE	3:1	WEIGHT	1 g	SHEET	1/1
-------	-----	--------	-----	-------	-----

See also our general installation guide: www.ledil.com/installation_guide

OPTICAL RESULTS (MEASURED):



LED NCSxx19A
FWHM / FWTM 25.0° / 51.0°
Efficiency 89 %
Peak intensity 2.8 cd/lm
LEDs/each optic 1
Light colour White
Required components:

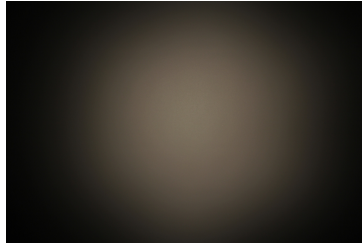

SAMSUNG

LED LH181A
FWHM / FWTM 28.0° / 54.0°
Efficiency 80 %
Peak intensity 2.6 cd/lm
LEDs/each optic 1
Light colour White
Required components:

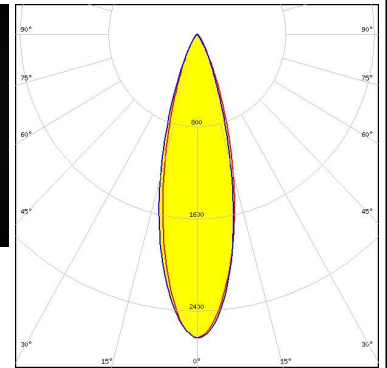
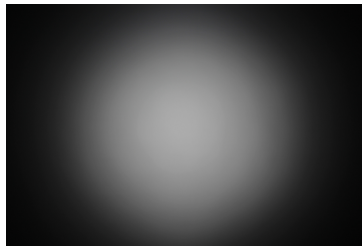

SAMSUNG

LED LH181B
FWHM / FWTM 28.0° / 52.0°
Efficiency 86 %
Peak intensity 3 cd/lm
LEDs/each optic 1
Light colour White
Required components:

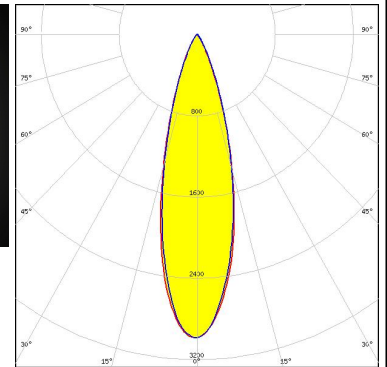
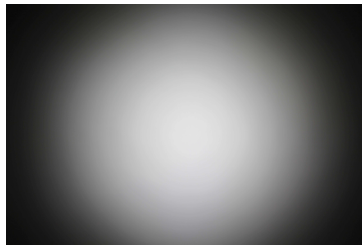

OPTICAL RESULTS (SIMULATED):



LED XP-G3
 FWHM / FWTM 32.0° / 59.0°
 Efficiency 84 %
 Peak intensity 2.3 cd/lm
 LEDs/each optic 1
 Light colour White
 Required components:

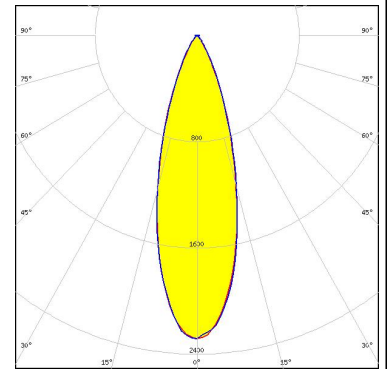

LED LUXEON HL1Z
 FWHM / FWTM 28.0 + 29.0° / 48.0 + 52.0°
 Efficiency 90 %
 Peak intensity 3.3 cd/lm
 LEDs/each optic 1
 Light colour White
 Required components:

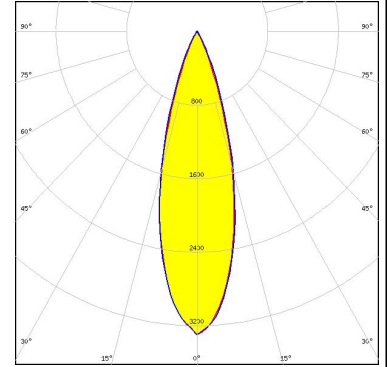

LED LUXEON SunPlus 20 Line (150 deg)
 FWHM / FWTM 30.0° / 54.0°
 Efficiency 88 %
 Peak intensity 3 cd/lm
 LEDs/each optic 1
 Light colour White
 Required components:

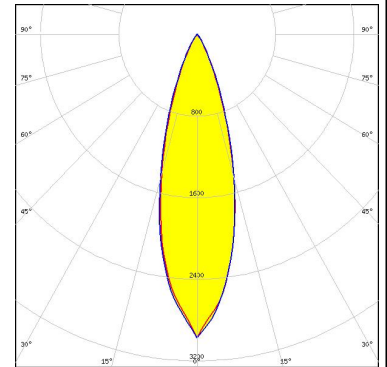

LED NCSxE17A
 FWHM / FWTM 35.0° / 70.0°
 Efficiency 79 %
 Peak intensity 1.6 cd/lm
 LEDs/each optic 4
 Light colour White
 Required components:

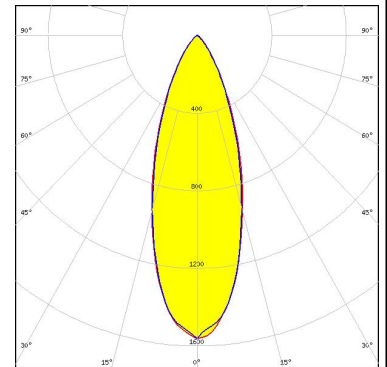

OPTICAL RESULTS (SIMULATED):



LED NVSxE21A
FWHM / FWTM 28.0° / 53.0°
Efficiency 88 %
Peak intensity 3.1 cd/lm
LEDs/each optic 1
Light colour White
Required components:

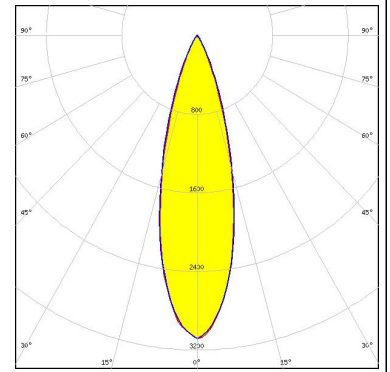

LED NVSxx19A
FWHM / FWTM 32.0° / 59.0°
Efficiency 84 %
Peak intensity 2.4 cd/lm
LEDs/each optic 1
Light colour White
Required components:

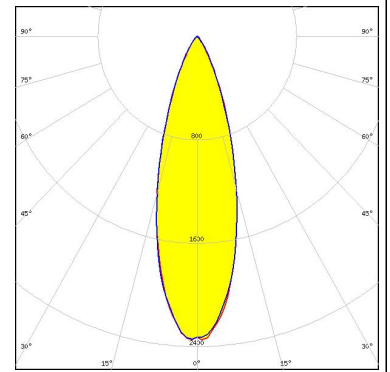

GENERAL INFORMATION:

NOTE: The typical beam angle will be changed by different color, chip size and chip position tolerance. The typical total beam angle is the full angle measured where the luminous intensity is half of the peak value.

MATERIALS:

As part of our continuous research and improvement processes, and to ensure the best possible quality and availability of our products, LEDiL reserves the right to change material grades without notice.

PRODUCT DATA USER AGREEMENT AND DISCLAIMER:

The measured data in the provided downloadable LEDiL Product Datasheets and Mechanical 2D-Drawings is rounded and provided as reference for planning. LEDiL Oy's optical specifications have been verified by conducting performance testing of the products in accordance with the company's quality system. The reported data are averaged results of multiple measurements with typical variation. LEDiL Oy reserves the right to without prior notification make changes and improvements to its products.

LEDiL Oy assumes neither warranty, nor guarantee nor any other liability of any kind for the contents and correctness of the provided data. The provided data has been generated with highest diligence but the provided data may in reality not represent the complete possible variation range of all intrinsic parameters. Therefore, in certain cases a deviation from the provided data could occur.

LEDiL Oy reserves the right to undertake technical changes of its products without further notification which could lead to changes in the provided data. LEDiL Oy assumes no liability of any kind for the possible deviation from any provided data or any other damage resulting from the usage of the provided data.

The user agrees to this disclaimer and user agreement with the download or usage of the provided files.

LEDiL Oy

Joensuunkatu 13
FI-24240 SALO
Finland

LEDiL Inc.

228 West Page Street
Suite D
Sycamore IL 60178
USA

Ledil Optics Technology (Shenzhen) Co., Ltd.

405 , Block B
Casic Motor Building
Shenzhen 518057
P.R.CHINA

Local sales and technical support

[www.ledil.com/
where_to_buy](http://www.ledil.com/where_to_buy)

Shipping locations

Salo, Finland
Hong Kong, China

Distribution Partners

[www.ledil.com/
where_to_buy](http://www.ledil.com/where_to_buy)