

## BOOM-W

~55° wide beam. Assembly with 0.2 mm thick installation tape.

### SPECIFICATION:

Dimensions	Ø 22.2 mm
Height	14.3 mm
Fastening	glue, tape
ROHS compliant	yes ⓘ

### MATERIALS:

Component	Type	Material	Colour	Finish
BOOM-W	Reflector	PC	metal	
BOOM-TAPE	Tape	PET tape	clear	

### ORDERING INFORMATION:

Component		Qty in box	MOQ	MPQ	Box weight (kg)
CA10931_BOOM-W	Reflector	1680	336	112	5.2
» Box size: 480 x 280 x 300 mm					



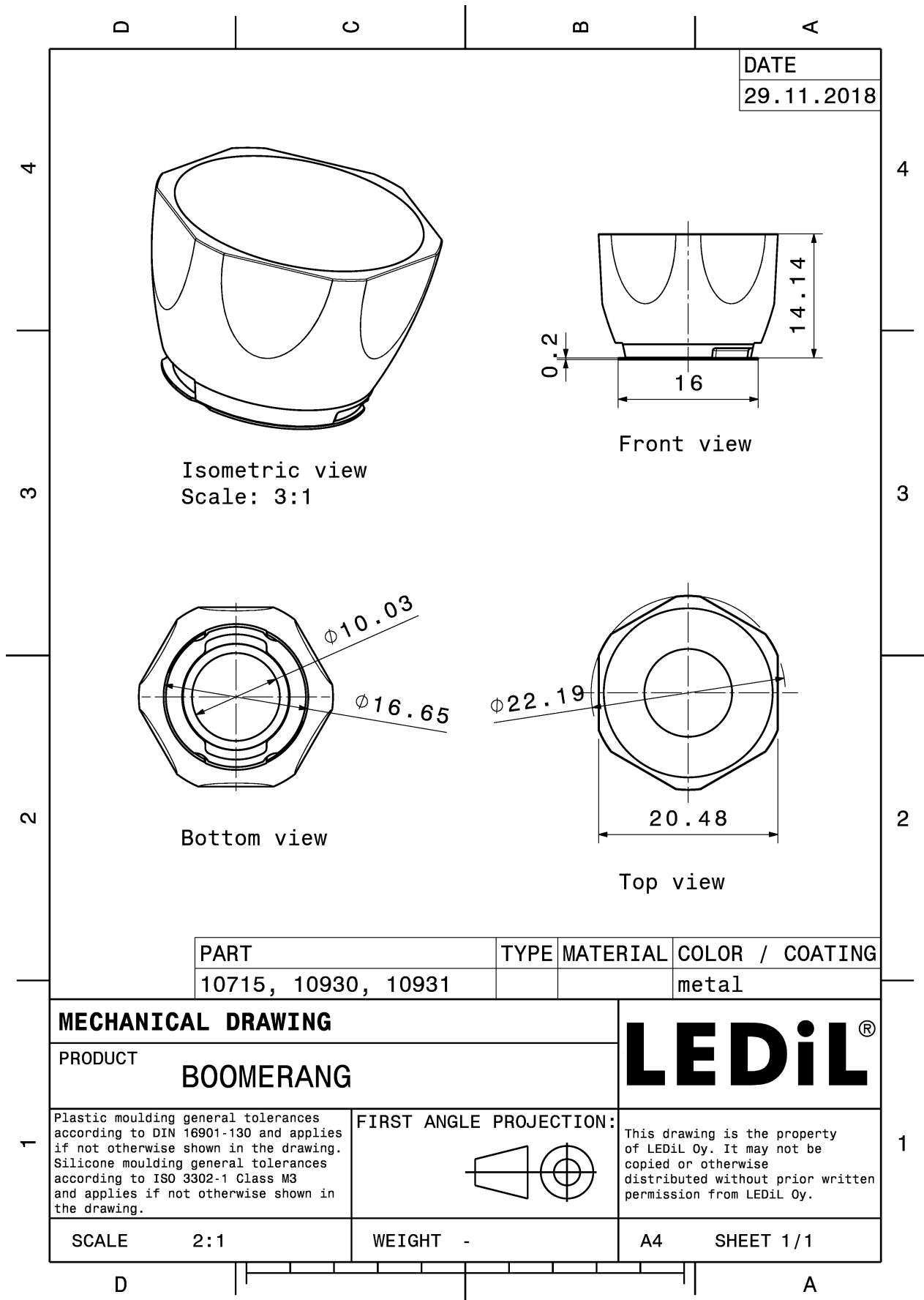

DATE
29.11.2018

Isometric view  
Scale: 3:1

Front view

Bottom view

Top view

PART	TYPE	MATERIAL	COLOR / COATING
10715, 10930, 10931			metal

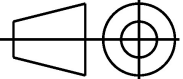
<b>MECHANICAL DRAWING</b>		<b>LEDiL®</b>
PRODUCT <b>BOOMERANG</b>		
Plastic moulding general tolerances according to DIN 16901-130 and applies if not otherwise shown in the drawing. Silicone moulding general tolerances according to ISO 3302-1 Class M3 and applies if not otherwise shown in the drawing.	FIRST ANGLE PROJECTION: 	This drawing is the property of LEDiL Oy. It may not be copied or otherwise distributed without prior written permission from LEDiL Oy.
SCALE 2:1	WEIGHT -	

See also our general installation guide: [www.ledil.com/installation\\_guide](http://www.ledil.com/installation_guide)

### OPTICAL RESULTS (MEASURED):



LED MHB-A/B  
 FWHM / FWTM 49.0° / 80.0°  
 Efficiency 84 %  
 Peak intensity 1.3 cd/m  
 LEDs/each optic 1  
 Light colour White  
 Required components:

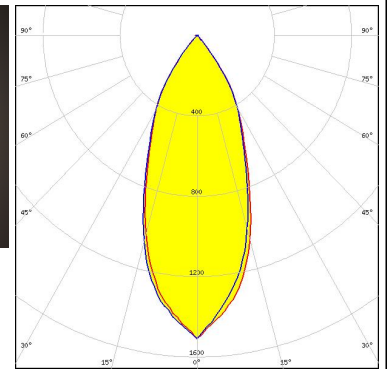
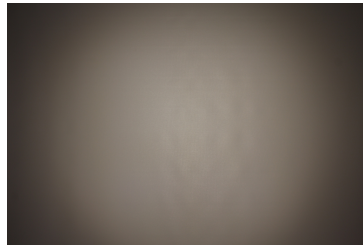

LED LUXEON M/MX  
 FWHM / FWTM 43.0° / 78.0°  
 Efficiency 84 %  
 Peak intensity 1.3 cd/m  
 LEDs/each optic 1  
 Light colour White  
 Required components:

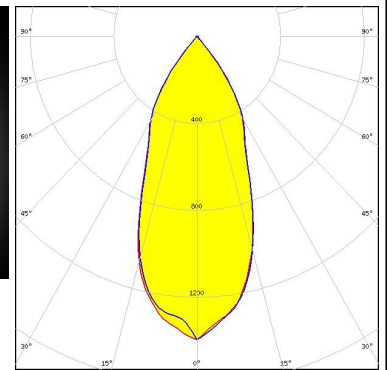

LED LUXEON MZ  
 FWHM / FWTM 33.0° / 72.0°  
 Efficiency 82 %  
 Peak intensity 1.9 cd/m  
 LEDs/each optic 1  
 Light colour White  
 Required components:

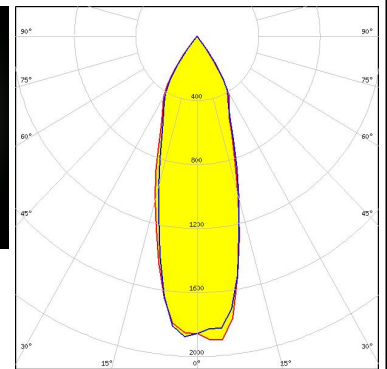
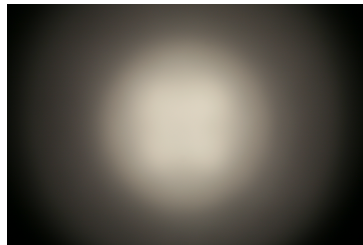

LED NFMW48xA  
 FWHM / FWTM 38.0° / 74.0°  
 Efficiency 84 %  
 Peak intensity 1.6 cd/m  
 LEDs/each optic 1  
 Light colour White  
 Required components:

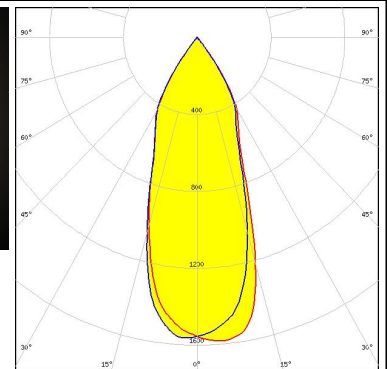
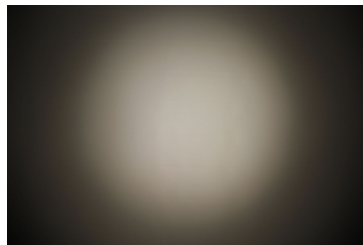

### OPTICAL RESULTS (MEASURED):

#### OSRAM Opto Semiconductors

LED Duris S10  
FWHM / FWTM 41.0° / 75.0°  
Efficiency 80 %  
Peak intensity 1.5 cd/lm  
LEDs/each optic 1  
Light colour White  
Required components:

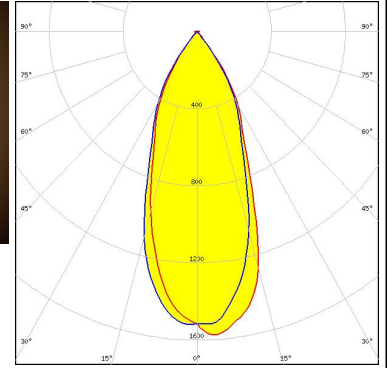

#### SEOUL SEMICONDUCTOR

LED P7  
FWHM / FWTM 70.0° / 88.0°  
Efficiency %  
Peak intensity 0.7 cd/lm  
LEDs/each optic 1  
Light colour White  
Required components:

### OPTICAL RESULTS (SIMULATED):



LED MC-E  
 FWHM / FWTM 37.0° / 76.0°  
 Efficiency 90 %  
 Peak intensity 1.7 cd/lm  
 LEDs/each optic 1  
 Light colour White  
 Required components:

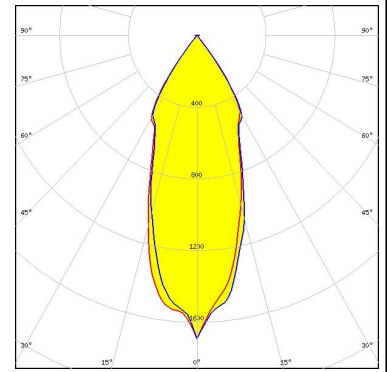

LED XHP35.2 HD  
 FWHM / FWTM 34.0° / 74.0°  
 Efficiency 84 %  
 Peak intensity 1.8 cd/lm  
 LEDs/each optic 1  
 Light colour White  
 Required components:

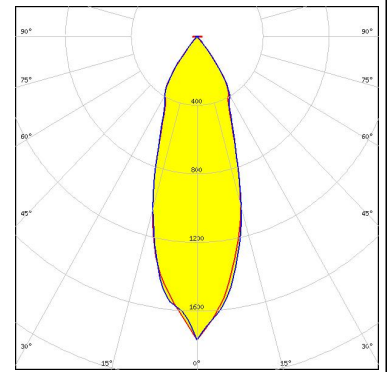

LED LUXEON 5050 Round LES  
 FWHM / FWTM 34.0° / 72.0°  
 Efficiency 86 %  
 Peak intensity 1.9 cd/lm  
 LEDs/each optic 1  
 Light colour White  
 Required components:

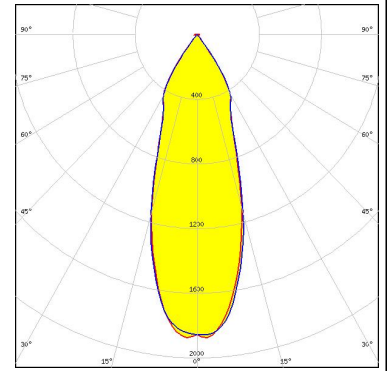

LED Duris S8  
 FWHM / FWTM 36.8° / 74.3°  
 Efficiency 87 %  
 Peak intensity 1.7 cd/lm  
 LEDs/each optic 1  
 Light colour White  
 Required components:

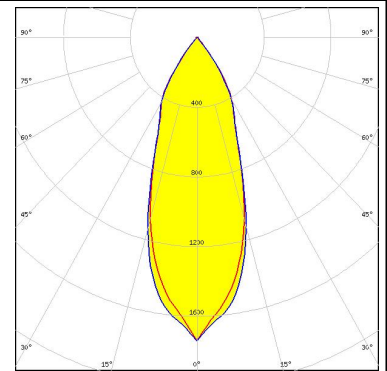

## OPTICAL RESULTS (SIMULATED):

**OSRAM**  
Opto Semiconductors

LED	OSCONIQ P 7070
FWHM / FWTM	40.0° / 76.0°
Efficiency	86 %
Peak intensity	1.6 cd/lm
LEDs/each optic	1
Light colour	White
Required components:	

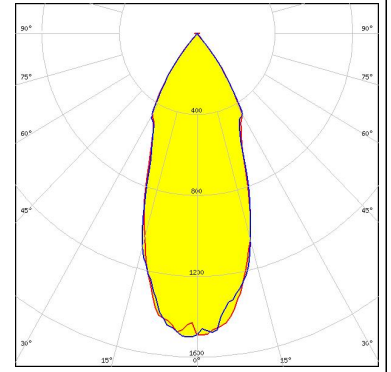

### GENERAL INFORMATION:

NOTE: The typical beam angle will be changed by different color, chip size and chip position tolerance. The typical total beam angle is the full angle measured where the luminous intensity is half of the peak value.

### MATERIALS:

As part of our continuous research and improvement processes, and to ensure the best possible quality and availability of our products, LEDiL reserves the right to change material grades without notice.

### PRODUCT DATA USER AGREEMENT AND DISCLAIMER:

The measured data in the provided downloadable LEDiL Product Datasheets and Mechanical 2D-Drawings is rounded and provided as reference for planning. LEDiL Oy's optical specifications have been verified by conducting performance testing of the products in accordance with the company's quality system. The reported data are averaged results of multiple measurements with typical variation. LEDiL Oy reserves the right to without prior notification make changes and improvements to its products.

LEDiL Oy assumes neither warranty, nor guarantee nor any other liability of any kind for the contents and correctness of the provided data. The provided data has been generated with highest diligence but the provided data may in reality not represent the complete possible variation range of all intrinsic parameters. Therefore, in certain cases a deviation from the provided data could occur.

LEDiL Oy reserves the right to undertake technical changes of its products without further notification which could lead to changes in the provided data. LEDiL Oy assumes no liability of any kind for the possible deviation from any provided data or any other damage resulting from the usage of the provided data.

The user agrees to this disclaimer and user agreement with the download or usage of the provided files.

#### LEDiL Oy

Joensuunkatu 13  
FI-24240 SALO  
Finland

#### LEDiL Inc.

228 West Page Street  
Suite D  
Sycamore IL 60178  
USA

#### Ledil Optics Technology (Shenzhen) Co., Ltd.

# 405 , Block B  
Casic Motor Building  
Shenzhen 518057  
P.R.CHINA

#### Local sales and technical support

[www.ledil.com/  
where\\_to\\_buy](http://www.ledil.com/where_to_buy)

#### Shipping locations

Salo, Finland  
Hong Kong, China

#### Distribution Partners

[www.ledil.com/  
where\\_to\\_buy](http://www.ledil.com/where_to_buy)