

TINA-RS

~13° spot beam optimized for Osram Golden Dragon+. Assembly with holder and installation tape.

SPECIFICATION:

Dimensions	Ø 16.1 mm
Height	10.1 mm
Fastening	tape
ROHS compliant	yes ⓘ



MATERIALS:

Component	Type	Material	Colour	Finish
TINA-O-PLUS-RS	Single lens	PMMA	clear	
TINA-O-PLUS-H-TAPE-WHT	Holder	PC	white	
TINA-TAPE3	Tape	Acrylic foam	black	

ORDERING INFORMATION:

Component		Qty in box	MOQ	MPQ	Box weight (kg)
FA10886_TINA-RS	Single lens	2016	288	144	4.1
» Box size:					

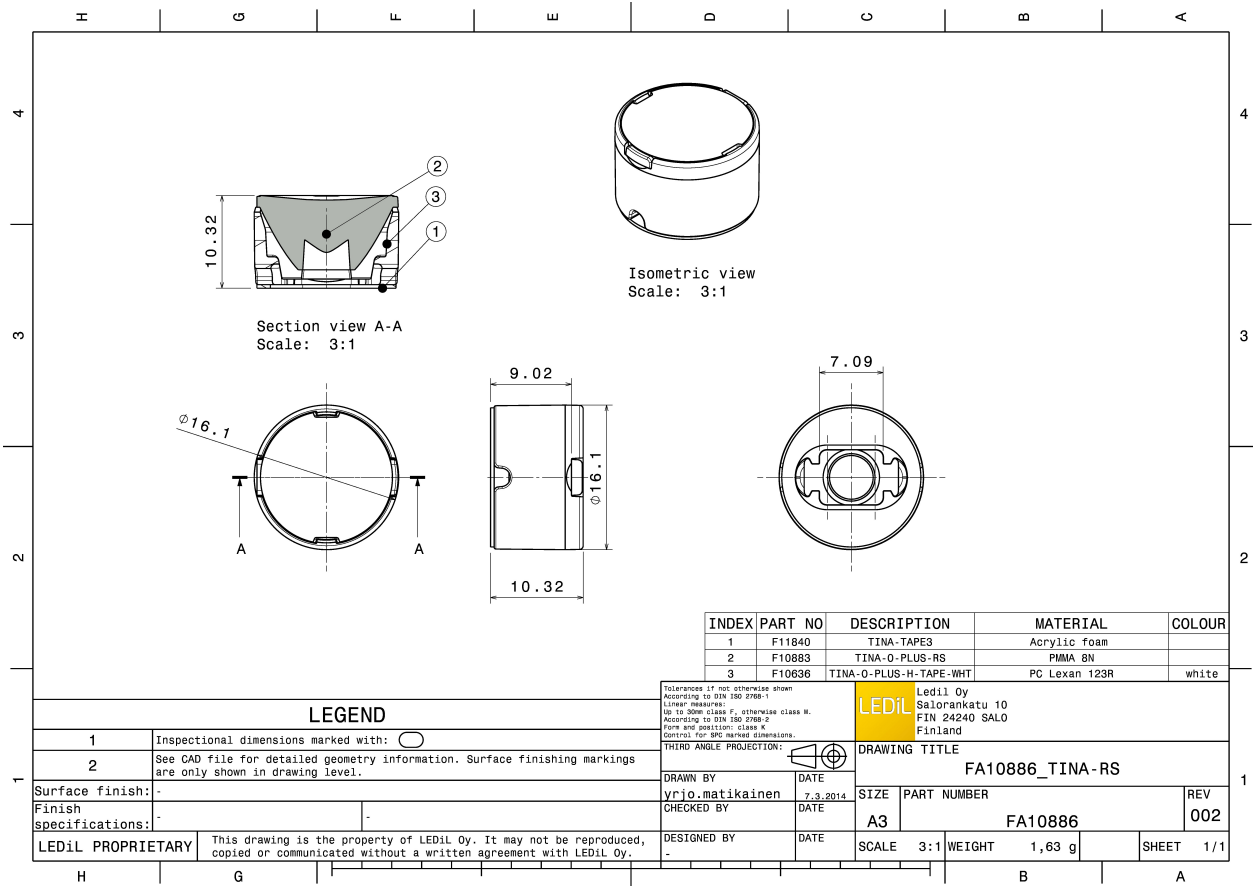

See also our general installation guide: www.ledil.com/installation_guide

OPTICAL RESULTS (MEASURED):

OSRAM
Opto Semiconductors

LED	Golden Dragon+
FWHM / FWTM	10.0° / 19.0°
Efficiency	93 %
Peak intensity	20.1 cd/lm
LEDs/each optic	1
Light colour	White
Required components:	

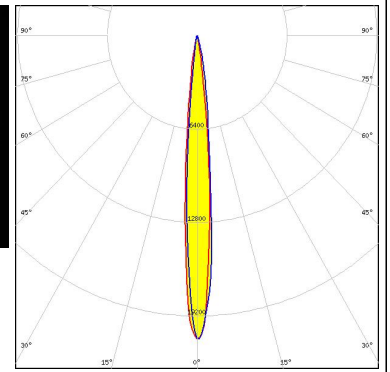

OPTICAL RESULTS (SIMULATED):

CREE LED

LED XP-E2
 FWHM / FWTM 10.0° / 25.0°
 Efficiency 88 %
 Peak intensity 13.1 cd/lm
 LEDs/each optic 1
 Light colour White
 Required components:

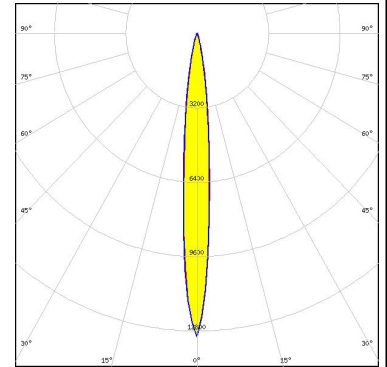

CREE LED

LED XP-G3
 FWHM / FWTM 16.0° / 36.0°
 Efficiency 85 %
 Peak intensity 6.1 cd/lm
 LEDs/each optic 1
 Light colour White
 Required components:

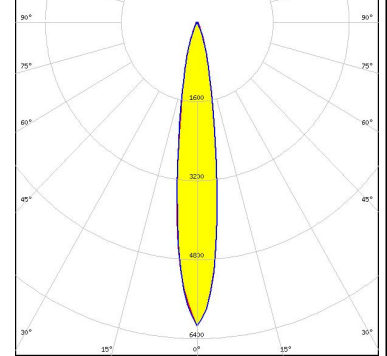

CREE LED

LED XP-L HI
 FWHM / FWTM 12.0° / 32.0°
 Efficiency 89 %
 Peak intensity 8.6 cd/lm
 LEDs/each optic 1
 Light colour White
 Required components:

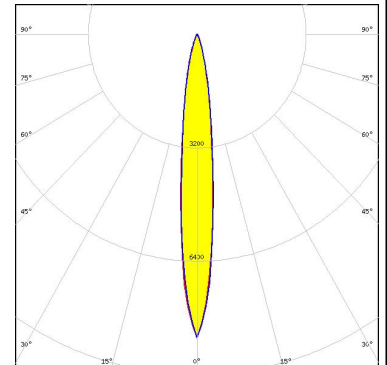

CREE LED

LED XT-E
 FWHM / FWTM 12.0° / 32.0°
 Efficiency 81 %
 Peak intensity 6.8 cd/lm
 LEDs/each optic 1
 Light colour White
 Required components:

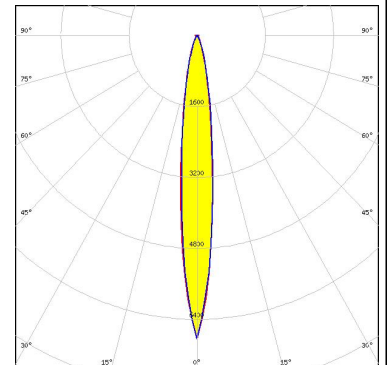

OPTICAL RESULTS (SIMULATED):

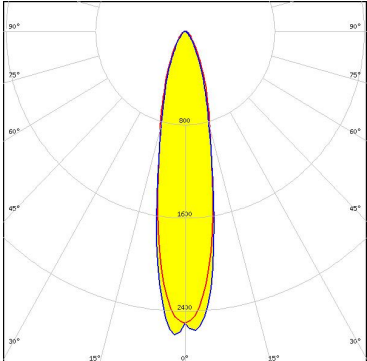
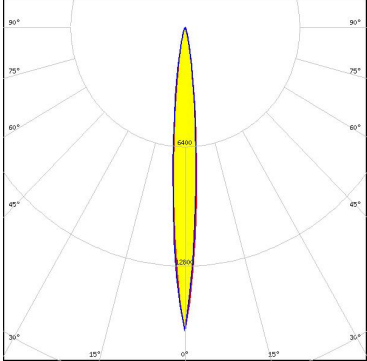
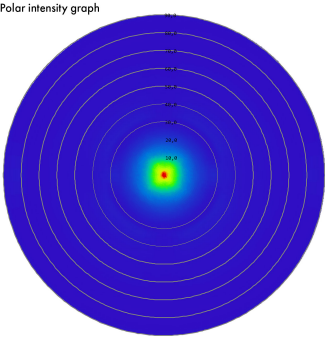
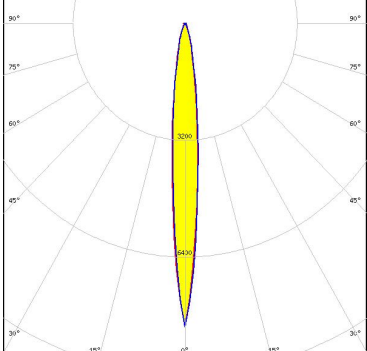
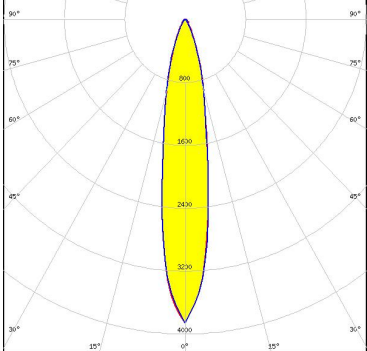
<p>LUMILEDS</p> <p>LED: LUXEON 5050 Square LES</p> <p>FWHM / FWTM: 22.0° / 56.0°</p> <p>Efficiency: 84 %</p> <p>Peak intensity: 2.6 cd/lm</p> <p>LEDs/each optic: 1</p> <p>Light colour: White</p> <p>Required components:</p>		
<p>LUMILEDS</p> <p>LED: LUXEON CZ</p> <p>FWHM / FWTM: 10.0° / 22.0°</p> <p>Efficiency: 88 %</p> <p>Peak intensity: 16.3 cd/lm</p> <p>LEDs/each optic: 1</p> <p>Light colour: Red</p> <p>Required components:</p>		
<p>LUMILEDS</p> <p>LED: LUXEON IR Domed 150 (L110-0xxx150000000)</p> <p>FWHM / FWTM: 10.0° / 28.0°</p> <p>Efficiency: 80 %</p> <p>LEDs/each optic: 1</p> <p>Light colour: IR</p> <p>Required components:</p>	<p>Polar intensity graph</p> 	
<p>NICHIA</p> <p>LED: NV4WB35AM</p> <p>FWHM / FWTM: 18.0° / 46.0°</p> <p>Efficiency: 85 %</p> <p>Peak intensity: 3.7 cd/lm</p> <p>LEDs/each optic: 1</p> <p>Light colour: White</p> <p>Required components:</p>		

OPTICAL RESULTS (SIMULATED):

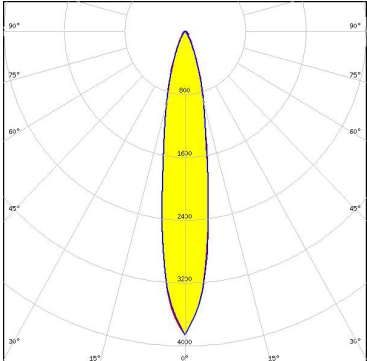
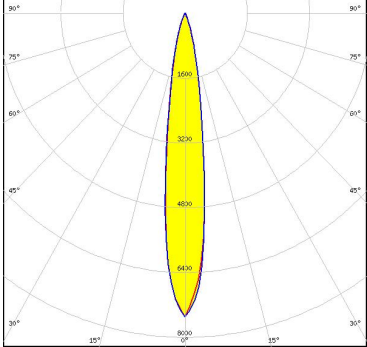
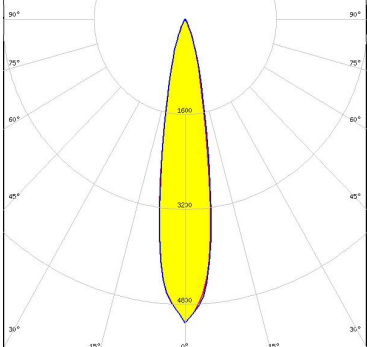
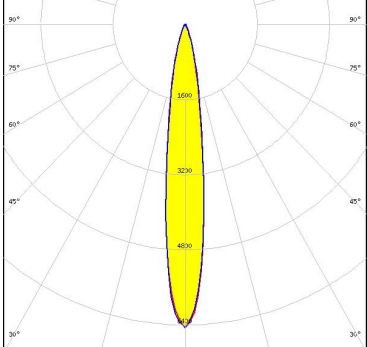
<p>NICHIA</p> <p>LED: NV4WB35AM FWHM / FWTM: 18.0° / 45.0° Efficiency: 85 % Peak intensity: 3.9 cd/lm LEDs/each optic: 1 Light colour: White Required components:</p>	
<p>NICHIA</p> <p>LED: NVSW219F FWHM / FWTM: 14.0° / 34.0° Efficiency: 88 % Peak intensity: 7.5 cd/lm LEDs/each optic: 1 Light colour: White Required components:</p>	
<p>NICHIA</p> <p>LED: NVSW519A FWHM / FWTM: 19.0° / 40.0° Efficiency: 85 % Peak intensity: 5.1 cd/lm LEDs/each optic: 1 Light colour: White Required components:</p>	
<p>NICHIA</p> <p>LED: NVSxx19B/NVSxx19C FWHM / FWTM: 14.0° / 34.0° Efficiency: 84 % Peak intensity: 6.5 cd/lm LEDs/each optic: 1 Light colour: White Required components:</p>	

OPTICAL RESULTS (SIMULATED):

OSRAM

Opto Semiconductors

LED OSLON Boost HX (KW CULPM1.TG)
FWHM / FWTM 11.0° / 27.0°
Efficiency 88 %
Peak intensity 11.1 cd/lm
LEDs/each optic 1
Light colour White
Required components:

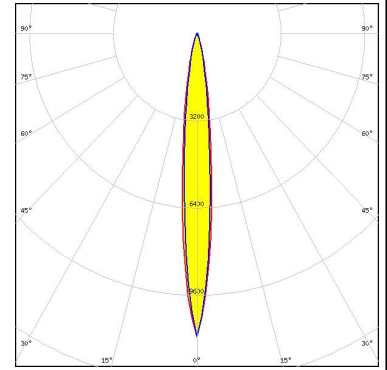

OSRAM

Opto Semiconductors

LED SFH 4716AS
FWHM / FWTM 8.0° / 26.0°
Efficiency 83 %
LEDs/each optic 1
Light colour IR
Required components:

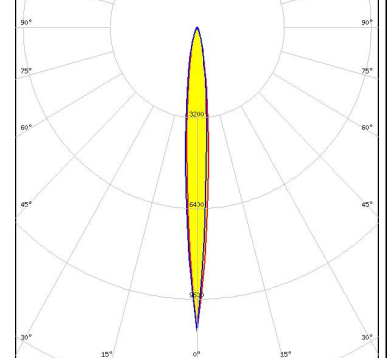
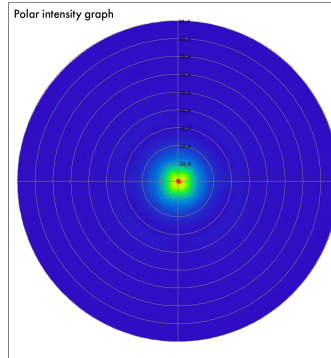

SAMSUNG

LED LH351C
FWHM / FWTM 16.0° / 37.0°
Efficiency 91 %
Peak intensity 6.4 cd/lm
LEDs/each optic 1
Light colour White
Required components:

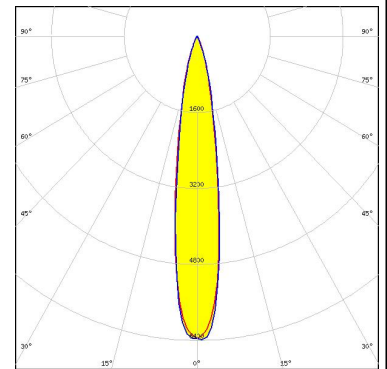

GENERAL INFORMATION:

NOTE: The typical beam angle will be changed by different color, chip size and chip position tolerance. The typical total beam angle is the full angle measured where the luminous intensity is half of the peak value.

MATERIALS:

As part of our continuous research and improvement processes, and to ensure the best possible quality and availability of our products, LEDiL reserves the right to change material grades without notice.

PRODUCT DATA USER AGREEMENT AND DISCLAIMER:

The measured data in the provided downloadable LEDiL Product Datasheets and Mechanical 2D-Drawings is rounded and provided as reference for planning. LEDiL Oy's optical specifications have been verified by conducting performance testing of the products in accordance with the company's quality system. The reported data are averaged results of multiple measurements with typical variation. LEDiL Oy reserves the right to without prior notification make changes and improvements to its products.

LEDiL Oy assumes neither warranty, nor guarantee nor any other liability of any kind for the contents and correctness of the provided data. The provided data has been generated with highest diligence but the provided data may in reality not represent the complete possible variation range of all intrinsic parameters. Therefore, in certain cases a deviation from the provided data could occur.

LEDiL Oy reserves the right to undertake technical changes of its products without further notification which could lead to changes in the provided data. LEDiL Oy assumes no liability of any kind for the possible deviation from any provided data or any other damage resulting from the usage of the provided data.

The user agrees to this disclaimer and user agreement with the download or usage of the provided files.

LEDiL Oy

Joensuunkatu 13
FI-24240 SALO
Finland

LEDiL Inc.

228 West Page Street
Suite D
Sycamore IL 60178
USA

Ledil Optics Technology (Shenzhen) Co., Ltd.

405 , Block B
Casic Motor Building
Shenzhen 518057
P.R.CHINA

Local sales and technical support

[www.ledil.com/
where_to_buy](http://www.ledil.com/where_to_buy)

Shipping locations

Salo, Finland
Hong Kong, China

Distribution Partners

[www.ledil.com/
where_to_buy](http://www.ledil.com/where_to_buy)