

CUTE-3-M

~25° medium beam with 3 mm high location pins

SPECIFICATION:

Dimensions	Ø 35.0 mm
Height	15 mm
Fastening	glue, pin
ROHS compliant	yes ⓘ



MATERIALS:

Component	Type	Material	Colour	Finish
CUTE-3-M	Multi-lens	PMMA	clear	





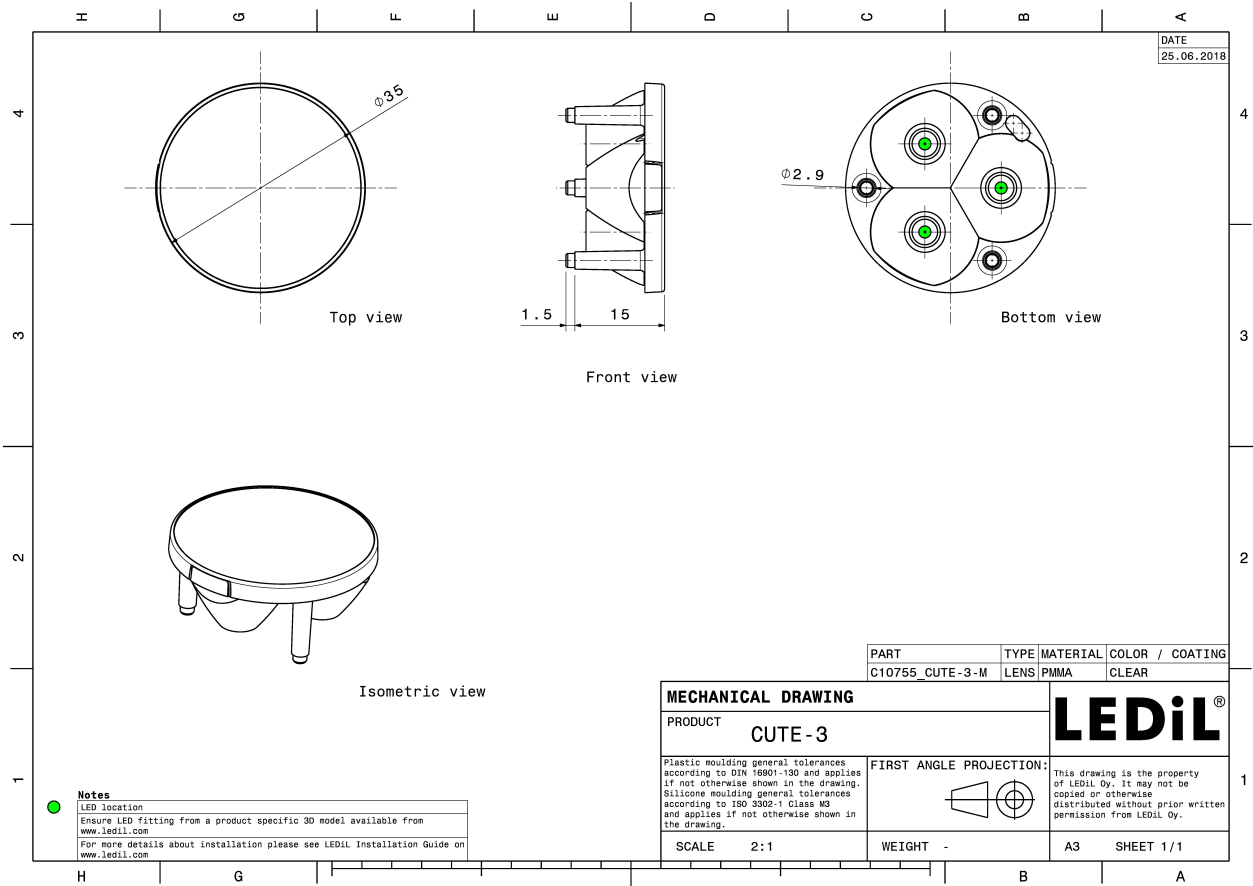

ORDERING INFORMATION:

Component	Qty in box	MOQ	MPQ	Box weight (kg)
C10755_CUTE-3-M » Box size: 480 x 280 x 300 mm	630	90	45	7.0

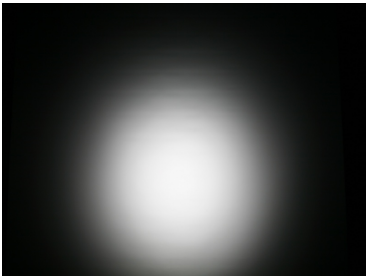
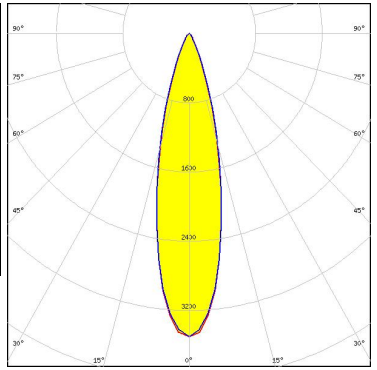

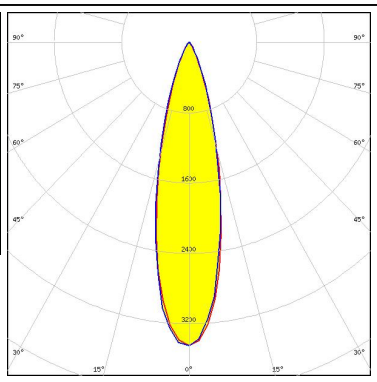
See also our general installation guide: www.ledil.com/installation_guide

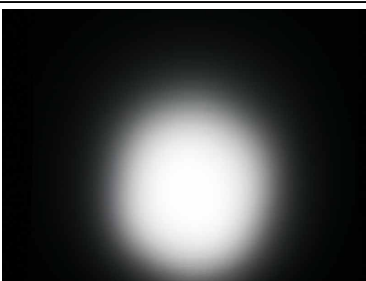
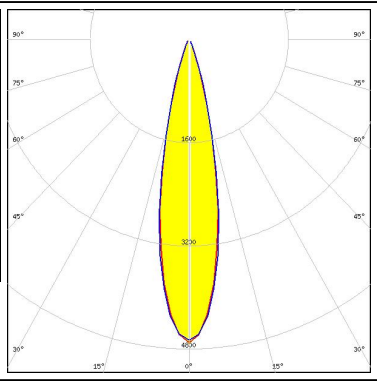
OPTICAL RESULTS (MEASURED):

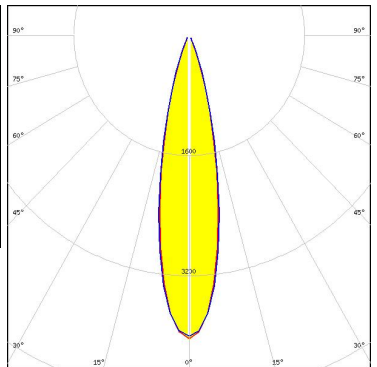
<p>CREE  LED</p> <p>LED XM-L FWHM / FWTM 25.0° / 48.0° Efficiency 90 % Peak intensity 3.5 cd/lm LEDs/each optic 1 Light colour White Required components:</p>		
<p>CREE  LED</p> <p>LED XM-L2 FWHM / FWTM 26.0° / 50.0° Efficiency 89 % Peak intensity 3.5 cd/lm LEDs/each optic 1 Light colour White Required components:</p>		
<p>CREE  LED</p> <p>LED XP-E FWHM / FWTM 22.0° / 40.0° Efficiency 92 % Peak intensity 4.7 cd/lm LEDs/each optic 1 Light colour White Required components:</p>		
<p>CREE  LED</p> <p>LED XP-G FWHM / FWTM 23.0° / 42.0° Efficiency 92 % Peak intensity 4 cd/lm LEDs/each optic 1 Light colour White Required components:</p>		

OPTICAL RESULTS (MEASURED):

CREE LED

LED XP-G2
 FWHM / FWTM 22.0° / 43.0°
 Efficiency 88 %
 Peak intensity 4.4 cd/m
 LEDs/each optic 1
 Light colour White
 Required components:

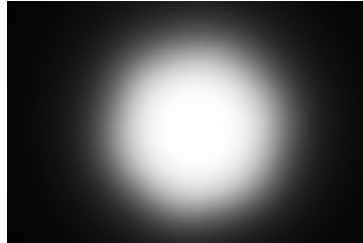

CREE LED

LED XT-E
 FWHM / FWTM 23.0° / 45.0°
 Efficiency 85 %
 Peak intensity 3.9 cd/m
 LEDs/each optic 1
 Light colour White
 Required components:

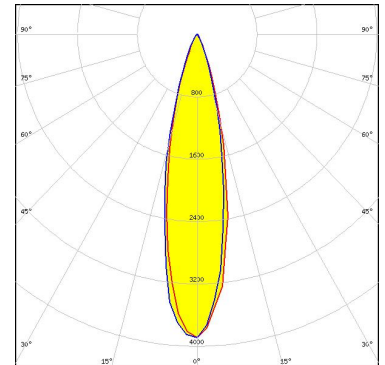

LUMILEDS

LED LUXEON A
 FWHM / FWTM 24.0°
 Efficiency 88 %
 LEDs/each optic 1
 Light colour White
 Required components:

LUMILEDS

LED LUXEON Rebel
 FWHM / FWTM 23.0° / 40.0°
 Efficiency 88 %
 Peak intensity 4.3 cd/m
 LEDs/each optic 1
 Light colour White
 Required components:

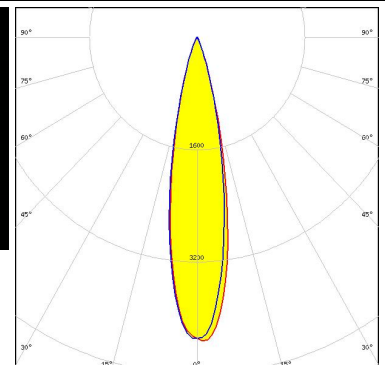
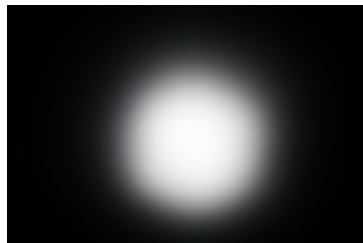

OPTICAL RESULTS (MEASURED):



LED LUXEON Rebel ES
FWHM / FWTM 24.0°
Efficiency 88 %
LEDs/each optic 1
Light colour White
Required components:



LED NCSxx19A
FWHM / FWTM 25.0°
Efficiency 89 %
LEDs/each optic 1
Light colour White
Required components:



LED NVSxx19A
FWHM / FWTM 24.0° / 48.0°
Efficiency 93 %
Peak intensity 3.3 cd/lm
LEDs/each optic 1
Light colour White
Required components:

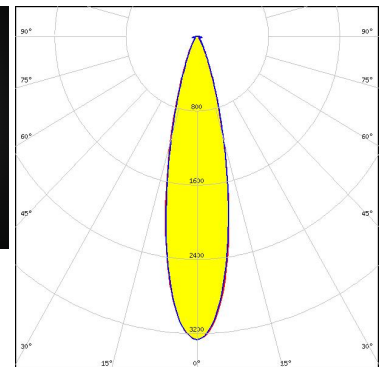
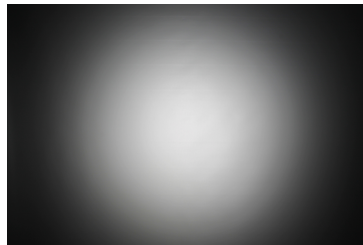

Opto Semiconductors
LED OSLOM Square EC
FWHM / FWTM 28.0° / 60.0°
Efficiency %
Peak intensity 2.2 cd/lm
LEDs/each optic 1
Light colour White
Required components:

OPTICAL RESULTS (MEASURED):

OSRAM

Opto Semiconductors

LED OSLON SSL 150
 FWHM / FWTM 31.0° / 58.0°
 Efficiency %
 Peak intensity 1.6 cd/lm
 LEDs/each optic 1
 Light colour White
 Required components:

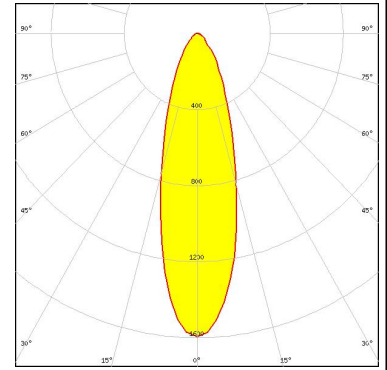

OSRAM

Opto Semiconductors

LED OSLON SSL 80
 FWHM / FWTM 23.0° / 38.0°
 Efficiency 89 %
 Peak intensity 4.1 cd/lm
 LEDs/each optic 1
 Light colour White
 Required components:

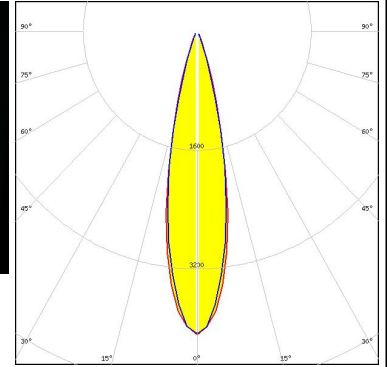
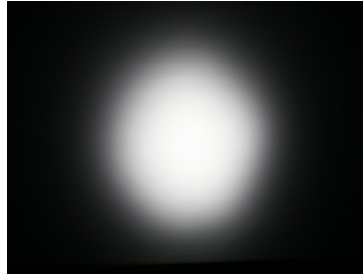

SEOUL SEMICONDUCTOR

LED Z5
 FWHM / FWTM 22.0°
 Efficiency %
 LEDs/each optic 1
 Light colour White
 Required components:



SEOUL SEMICONDUCTOR

LED Z5M1/Z5M2
 FWHM / FWTM 24.0° / 45.0°
 Efficiency 87 %
 Peak intensity 4 cd/lm
 LEDs/each optic 1
 Light colour White
 Required components:

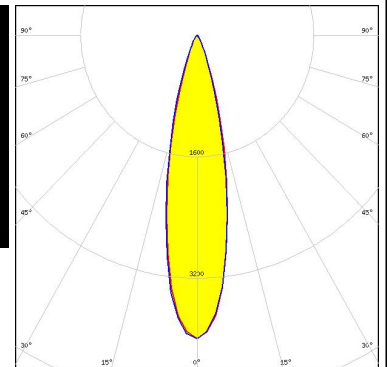
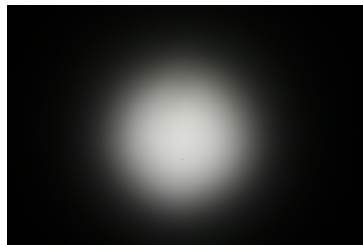

OPTICAL RESULTS (SIMULATED):



LED XM-L HVW
FWHM / FWTM 33.0°
Efficiency %
LEDs/each optic 1
Light colour White
Required components:



LED XP-G3
FWHM / FWTM 31.0° / 60.0°
Efficiency 91 %
Peak intensity 2.4 cd/lm
LEDs/each optic 1
Light colour White
Required components:

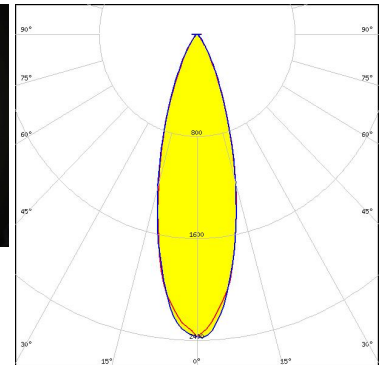
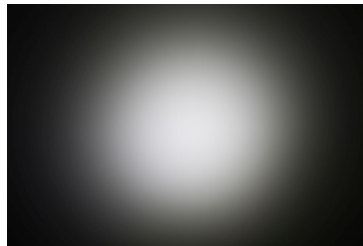

LED XT-E HVW
FWHM / FWTM 30.0°
Efficiency %
LEDs/each optic 1
Light colour White
Required components:

SAMSUNG

LED LH351B
FWHM / FWTM 30.0° / 57.0°
Efficiency 93 %
Peak intensity 2.6 cd/lm
LEDs/each optic 1
Light colour White
Required components:

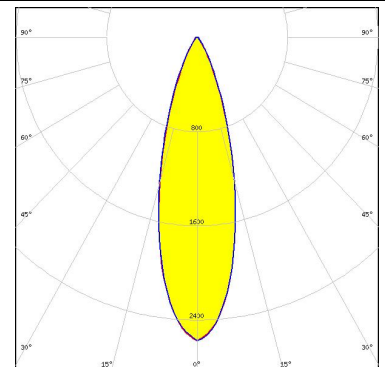

GENERAL INFORMATION:

NOTE: The typical beam angle will be changed by different color, chip size and chip position tolerance. The typical total beam angle is the full angle measured where the luminous intensity is half of the peak value.

MATERIALS:

As part of our continuous research and improvement processes, and to ensure the best possible quality and availability of our products, LEDiL reserves the right to change material grades without notice.

PRODUCT DATA USER AGREEMENT AND DISCLAIMER:

The measured data in the provided downloadable LEDiL Product Datasheets and Mechanical 2D-Drawings is rounded and provided as reference for planning. LEDiL Oy's optical specifications have been verified by conducting performance testing of the products in accordance with the company's quality system. The reported data are averaged results of multiple measurements with typical variation. LEDiL Oy reserves the right to without prior notification make changes and improvements to its products.

LEDiL Oy assumes neither warranty, nor guarantee nor any other liability of any kind for the contents and correctness of the provided data. The provided data has been generated with highest diligence but the provided data may in reality not represent the complete possible variation range of all intrinsic parameters. Therefore, in certain cases a deviation from the provided data could occur.

LEDiL Oy reserves the right to undertake technical changes of its products without further notification which could lead to changes in the provided data. LEDiL Oy assumes no liability of any kind for the possible deviation from any provided data or any other damage resulting from the usage of the provided data.

The user agrees to this disclaimer and user agreement with the download or usage of the provided files.

LEDiL Oy

Joensuunkatu 13
FI-24240 SALO
Finland

LEDiL Inc.

228 West Page Street
Suite D
Sycamore IL 60178
USA

Ledil Optics Technology (Shenzhen) Co., Ltd.

405 , Block B
Casic Motor Building
Shenzhen 518057
P.R.CHINA

Local sales and technical support

[www.ledil.com/
where_to_buy](http://www.ledil.com/where_to_buy)

Shipping locations

Salo, Finland
Hong Kong, China

Distribution Partners

[www.ledil.com/
where_to_buy](http://www.ledil.com/where_to_buy)