

EVA-D

~16° diffused spot beam

SPECIFICATION:

Dimensions	Ø 35.0 mm
Height	16.4 mm
Fastening	glue
ROHS compliant	yes ⓘ

MATERIALS:

Component	Type	Material	Colour	Finish
EVA-D	Single lens	PMMA	clear	

ORDERING INFORMATION:

Component	Qty in box	MOQ	MPQ	Box weight (kg)
C10684_EVA-D » Box size:	540	90	45	4.0



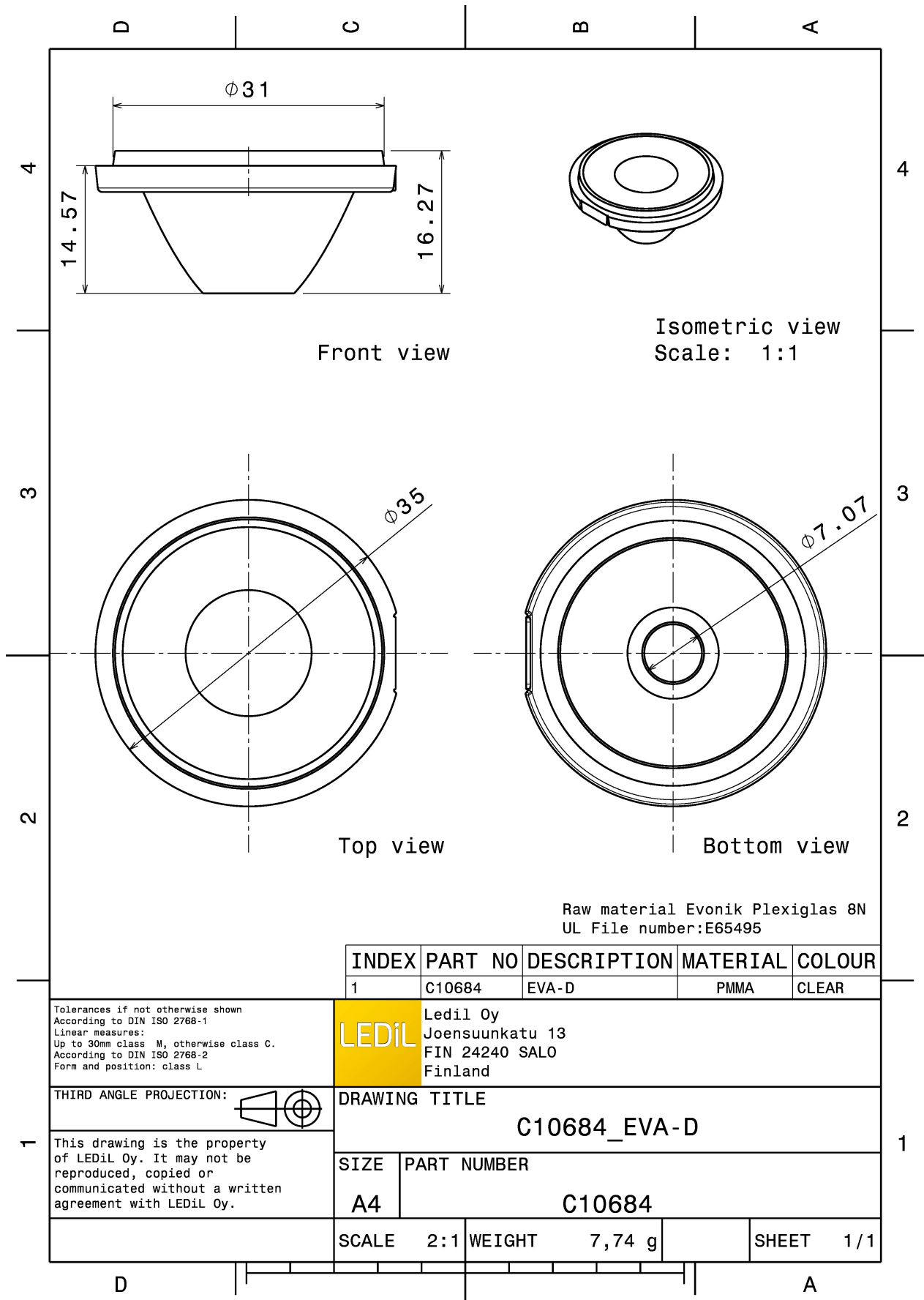

See also our general installation guide: www.ledil.com/installation_guide

OPTICAL RESULTS (MEASURED):

CITIZEN

LED CLU7A2/7A3
 FWHM / FWTM 16.0° / 33.0°
 Efficiency 92 %
 Peak intensity 7.5 cd/lm
 LEDs/each optic 1
 Light colour White
 Required components:

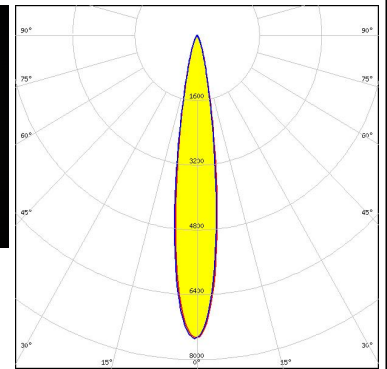

LED MC-E
 FWHM / FWTM 16.0°
 Efficiency 92 %
 Peak intensity 6 cd/lm
 LEDs/each optic 1
 Light colour White
 Required components:



LED MHB-A/B
 FWHM / FWTM 19.0° / 40.0°
 Efficiency 83 %
 Peak intensity 5.4 cd/lm
 LEDs/each optic 1
 Light colour White
 Required components:

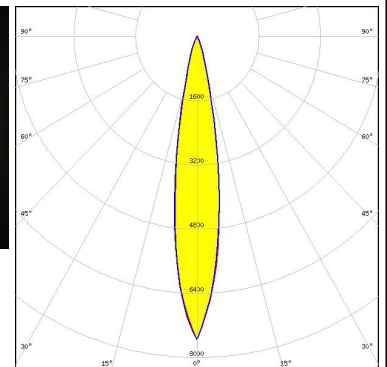
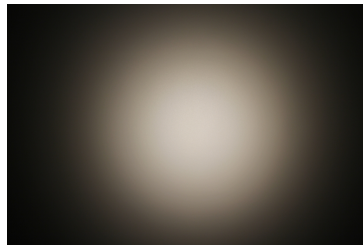

LED XHP35 HI
 FWHM / FWTM 22.0° / 46.0°
 Efficiency 79 %
 Peak intensity 3.9 cd/lm
 LEDs/each optic 1
 Light colour White
 Required components:

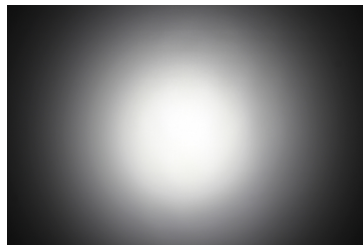

OPTICAL RESULTS (MEASURED):



LED XM-L
 FWHM / FWTM 16.0°
 Efficiency 91 %
 LEDs/each optic 1
 Light colour White
 Required components:



LED XP-G2
 FWHM / FWTM 16.0° / 30.0°
 Efficiency 87 %
 LEDs/each optic 1
 Light colour White
 Required components:



LED XT-E
 FWHM / FWTM 14.0°
 Efficiency %
 Peak intensity 7.5 cd/lm
 LEDs/each optic 1
 Light colour White
 Required components:

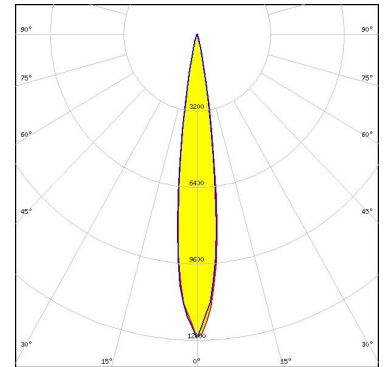

LED LUXEON 5050 Round LES
 FWHM / FWTM 18.0° / 35.0°
 Efficiency 91 %
 Peak intensity 6.4 cd/lm
 LEDs/each optic 1
 Light colour White
 Required components:

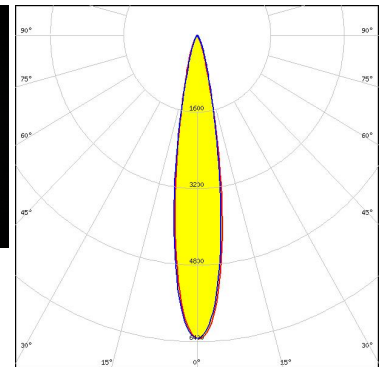
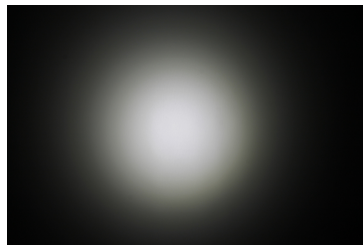

OPTICAL RESULTS (MEASURED):

LUMILEDS

LED LUXEON M/MX
 FWHM / FWTM 21.0°
 Efficiency 90 %
 Peak intensity 4.2 cd/lm
 LEDs/each optic 1
 Light colour White
 Required components:

LUMILEDS

LED LUXEON MZ
 FWHM / FWTM 16.0° / 33.0°
 Efficiency 88 %
 Peak intensity 7.8 cd/lm
 LEDs/each optic 1
 Light colour White
 Required components:

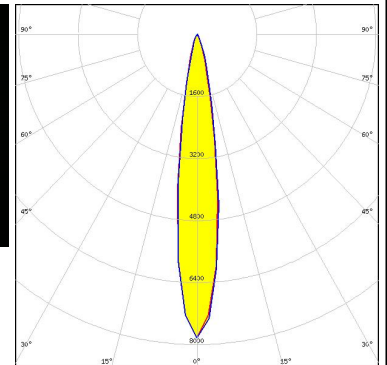

NICHIA

LED NS9x383
 FWHM / FWTM 16.0° / 34.0°
 Efficiency 89 %
 Peak intensity 6.8 cd/lm
 LEDs/each optic 1
 Light colour White
 Required components:

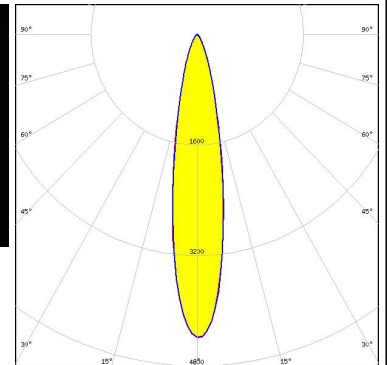

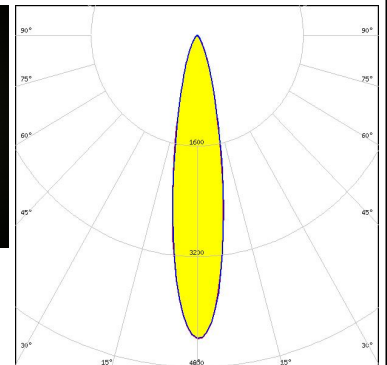

NICHIA

LED NSMx286M
 FWHM / FWTM 20.0° / 44.0°
 Efficiency 91 %
 Peak intensity 4.4 cd/lm
 LEDs/each optic 1
 Light colour White
 Required components:

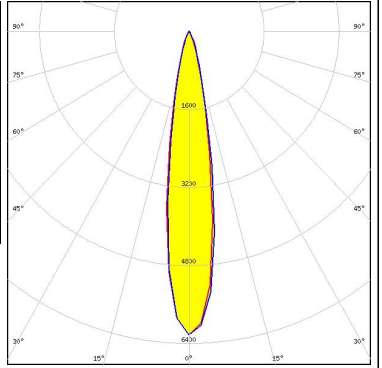

OPTICAL RESULTS (MEASURED):

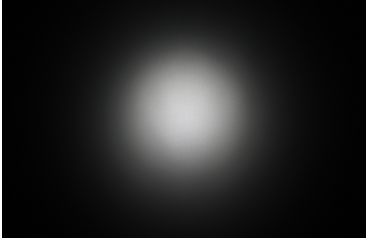
<p>OSRAM Opto Semiconductors</p> <p>LED Duris S8</p> <p>FWHM / FWTM 18.0° / 36.0°</p> <p>Efficiency 84 %</p> <p>Peak intensity 6.2 cd/lm</p> <p>LEDs/each optic 1</p> <p>Light colour White</p> <p>Required components:</p>		
<p>SEOUL SEOUL SEMICONDUCTOR</p> <p>LED Z8Y15</p> <p>FWHM / FWTM 13.0° / 28.0°</p> <p>Efficiency 86 %</p> <p>Peak intensity 11.5 cd/lm</p> <p>LEDs/each optic 1</p> <p>Light colour White</p> <p>Required components:</p>		
<p>SEOUL SEOUL SEMICONDUCTOR</p> <p>LED Z8Y19</p> <p>FWHM / FWTM 13.0° / 28.0°</p> <p>Efficiency 87 %</p> <p>Peak intensity 11 cd/lm</p> <p>LEDs/each optic 1</p> <p>Light colour White</p> <p>Required components:</p>		

OPTICAL RESULTS (SIMULATED):

LUMILEDS

LED LUXEON 5258
 FWHM / FWTM 17.0° / 30.0°
 Efficiency 92 %
 Peak intensity 8.6 cd/lm
 LEDs/each optic 1
 Light colour White
 Required components:

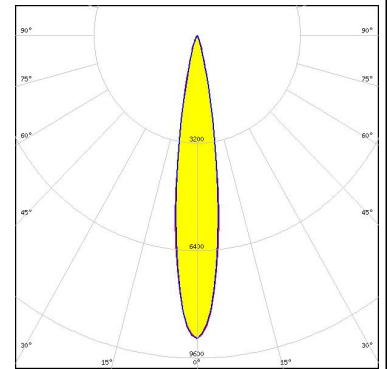

LUMINUS

LED CXM-3
 FWHM / FWTM 14.0° / 26.0°
 Efficiency 95 %
 Peak intensity 11.7 cd/lm
 LEDs/each optic 1
 Light colour White
 Required components:

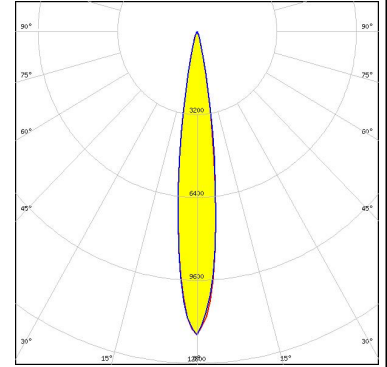

LUMINUS

LED CXM-4
 FWHM / FWTM 18.0° / 34.0°
 Efficiency 95 %
 Peak intensity 7.5 cd/lm
 LEDs/each optic 1
 Light colour White
 Required components:

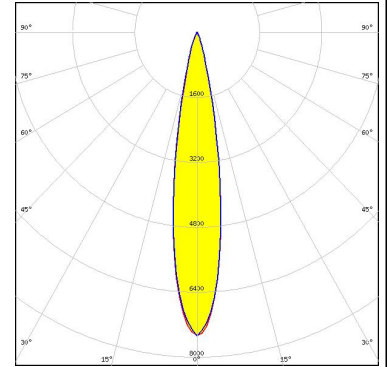

NICHIA

LED NFMW48xA
 FWHM / FWTM 22.0° / 39.0°
 Efficiency 96 %
 Peak intensity 5.6 cd/lm
 LEDs/each optic 1
 Light colour White
 Required components:

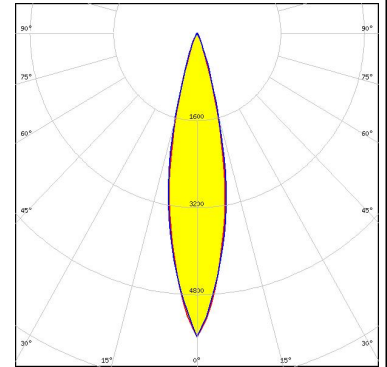

OPTICAL RESULTS (SIMULATED):

OSRAM
Opto Semiconductors

LED	OSCONIQ P 7070
FWHM / FWTM	20.0° / 33.0°
Efficiency	94 %
Peak intensity	6.9 cd/lm
LEDs/each optic	1
Light colour	White
Required components:	

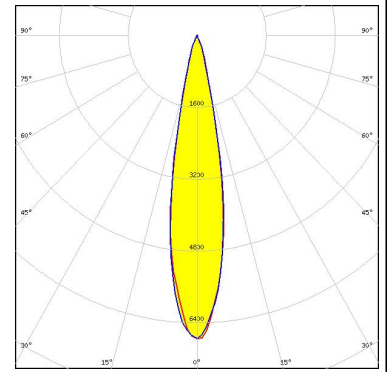

GENERAL INFORMATION:

NOTE: The typical beam angle will be changed by different color, chip size and chip position tolerance. The typical total beam angle is the full angle measured where the luminous intensity is half of the peak value.

Due to use of high power COB's with this product, special attention to proper thermal design is highly recommended. LEDiL has no liability for direct, indirect or consecutive damages arising from the LEDiL products being used outside of the recommended temperature range.

MATERIALS:

As part of our continuous research and improvement processes, and to ensure the best possible quality and availability of our products, LEDiL reserves the right to change material grades without notice.

PRODUCT DATA USER AGREEMENT AND DISCLAIMER:

The measured data in the provided downloadable LEDiL Product Datasheets and Mechanical 2D-Drawings is rounded and provided as reference for planning. LEDiL Oy's optical specifications have been verified by conducting performance testing of the products in accordance with the company's quality system. The reported data are averaged results of multiple measurements with typical variation. LEDiL Oy reserves the right to without prior notification make changes and improvements to its products.

LEDiL Oy assumes neither warranty, nor guarantee nor any other liability of any kind for the contents and correctness of the provided data. The provided data has been generated with highest diligence but the provided data may in reality not represent the complete possible variation range of all intrinsic parameters. Therefore, in certain cases a deviation from the provided data could occur.

LEDiL Oy reserves the right to undertake technical changes of its products without further notification which could lead to changes in the provided data. LEDiL Oy assumes no liability of any kind for the possible deviation from any provided data or any other damage resulting from the usage of the provided data.

The user agrees to this disclaimer and user agreement with the download or usage of the provided files.

LEDiL Oy

Joensuunkatu 13
FI-24240 SALO
Finland

LEDiL Inc.

228 West Page Street
Suite D
Sycamore IL 60178
USA

Ledil Optics Technology (Shenzhen) Co., Ltd.

405 , Block B
Casic Motor Building
Shenzhen 518057
P.R.CHINA

Local sales and technical support

[www.ledil.com/
where_to_buy](http://www.ledil.com/where_to_buy)

Shipping locations

Salo, Finland
Hong Kong, China

Distribution Partners

[www.ledil.com/
where_to_buy](http://www.ledil.com/where_to_buy)