

Order No.: 1061704

Type: FP 0,8/ 80-MV 2,65

SMD male connector, Reflow soldering

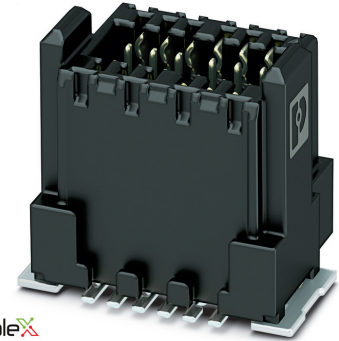

ScaleX

The figure shows a 12-pos. version with 12 contacts

1 Main features

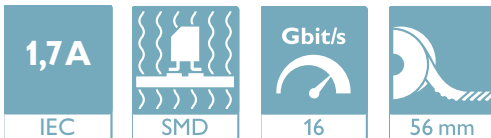

- | | | | |
|----------------|--------------|------------------------|-----------------|
| • No. of pos. | 80 | • Nominal current | 1.7 A |
| • Test voltage | 500 V AC | • Mounting type | SMD soldering |
| • Color | black (9005) | • Connection direction | 90 ° |
| • Pitch | 0.8 mm | • Type of packaging | 56 mm wide tape |

2 Your advantages

- ✓ Gold-plated contacts ensure transfer quality remains stable over the long term
- ✓ Reliable mechanical and electrical connections, thanks to the double-sided ScaleX contact system
- ✓ Robustness: ScaleX technology for high tolerance compensation and protection of contacts
- ✓ Flexible device design: various numbers of positions, designs, and stack heights with high wipe lengths



Make sure you always use the latest documentation.
It can be downloaded at: phoenixcontact.net/product/1061704

3 Table of contents

| | | |
|----|---|----|
| 1 | Main features..... | 1 |
| 2 | Your advantages | 1 |
| 3 | Table of contents | 2 |
| 4 | 3D model in PDF can be activated (Acrobat Reader only)..... | 3 |
| 5 | General Technical Data | 4 |
| | 5.1 item properties | 4 |
| | 5.2 Material data | 4 |
| 6 | Dimensions..... | 5 |
| | 6.1 Dimensions for the product | 5 |
| | 6.2 Dimensions for the application | 5 |
| 7 | Series drawing..... | 6 |
| 8 | Packaging information | 7 |
| 9 | Blister drawing..... | 8 |
| 10 | Application..... | 9 |
| | 10.1 Temperature limit values | 9 |
| 11 | General tests | 10 |
| | 11.1 Specification..... | 10 |
| 12 | Mechanical tests..... | 11 |
| | 12.1 Insertion and withdrawal force per contact | 11 |
| | 12.2 Service life | 11 |
| 13 | Electrical tests | 12 |
| | 13.1 Electrical data | 12 |
| | 13.2 Air and creepage distances | 12 |
| 14 | Current carrying capacity/derating curves | 13 |
| | 14.1 Insulation resistance..... | 13 |
| | 14.2 forward resistance | 13 |
| | 14.3 Vibration test | 13 |
| | 14.4 Shock test..... | 13 |
| 15 | Approvals / Certificates..... | 14 |
| 16 | Commercial Data..... | 15 |
| 17 | Combination tests..... | 16 |

1061704 FP 0,8/ 80-MV 2,65

4 3D model in PDF can be activated (Acrobat Reader only)



1061704 FP 0,8/ 80-MV 2,65**5 General Technical Data****5.1 item properties**

| | |
|--|---------------------|
| Order No. | 1061704 |
| Type | FP 0,8/ 80-MV 2,65 |
| Plug-in system | FINEPITCH 0,8 mm |
| Product type | SMD male connector |
| Type of contact | Male connector |
| Range of articles | FP 0,8/...-MV 2,65 |
| Pitch | 0.8 mm |
| Range of positions | 12...80 |
| Number of positions | 80 |
| Number of levels | 2 |
| Number of potentials | 80 |
| Mounting type | SMD soldering |
| Connection direction of the connector to the PCB | 90 ° |
| Pin layout | Linear pad geometry |

5.2 Material data

| | |
|--|---|
| Material of metal parts | |
| Note | WEEE/RoHS-compliant, whisker-free acc. to IEC 60068-2-82/JEDEC JESD 201 |
| Contact material | Cu alloy |
| Surface contact area | Nickel (Ni), , Gold (Au) |
| Soldering area surface | Nickel (Ni) , Tin (Sn) |
| Surface characteristics | Selective coating |
| Insulating material data | |
| Insulating material | LCP |
| Insulating material group | IIIa |
| CTI according to IEC 60112 | 150 |
| Flammability rating according to UL 94 | V0 |
| Color | black (9005) |

1061704 FP 0,8/ 80-MV 2,65**6 Dimensions****6.1 Dimensions for the product**

| | |
|--------------------------|-------------------------------------|
| Length | 6.1 mm |
| Width | 35.09 mm |
| Total height | 7.75 mm |
| Height | 7.15 mm |
| Positioning pin geometry | , Length of positioning pin: 0.6 mm |
| Coplanarity | ≤ 0.1 mm |

6.2 Dimensions for the application

| | |
|-------------------|---|
| Contact cover | 0.8 mm |
| Overlap length | 1.5 mm |
| Medium offset | ± 0.7 mm in longitudinal and transverse direction |
| Angular tolerance | ± 2 ° in longitudinal direction |
| Angular tolerance | ± 4 ° in transverse direction |
| Stacking height | 7.5 mm Tolerance: +1,5 mm (in combination with Range of articles:FP 0,8/...-FV 4,85) |
| Stacking height | 10.5 mm Tolerance: +1,5 mm (in combination with Range of articles:FP 0,8/...-FV 7,85) |

1061704 FP 0,8/ 80-MV 2,65

7 Series drawing

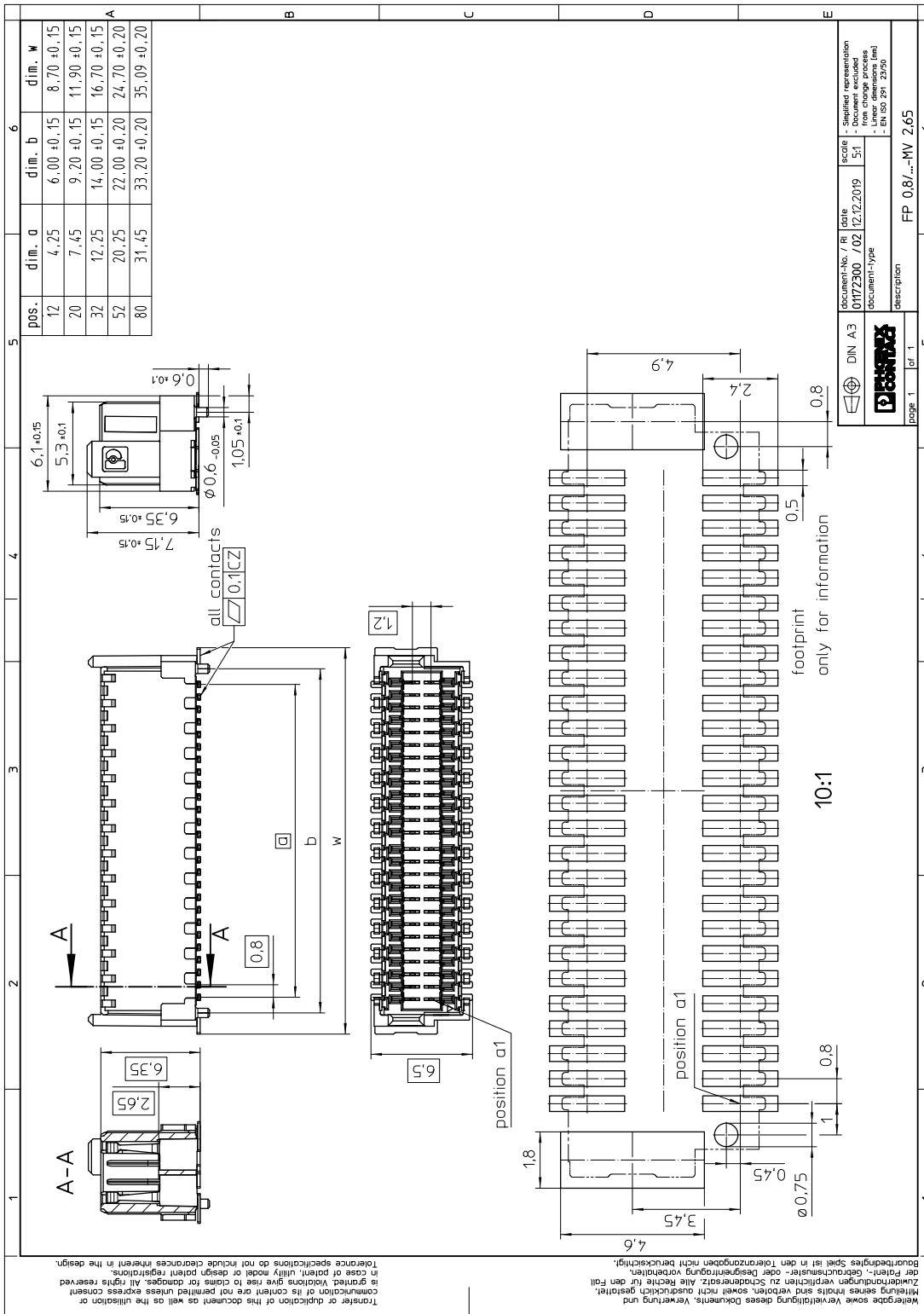

1061704 FP 0,8/ 80-MV 2,65**8 Packaging information**

| | |
|-----------------------------|---|
| Type of packaging | 56 mm wide tape |
| Note on packaging | Tape-on-reel packaging in accordance with standard DIN EN 60286-3 and EIA-481 |
| Pieces per package | 250 |
| Outer packaging type | Transparent-Bag |
| ESD level | (D) electrostatically conductive |
| Specification | DIN EN 61340-5-1 (VDE 0300-5-1): 2008-07 |
| [W] tape width | 56.4 mm |
| [A] coil diameter | 330 mm |
| [W2] coil overall dimension | 60.4 mm |
| Number of products per coil | 250 |

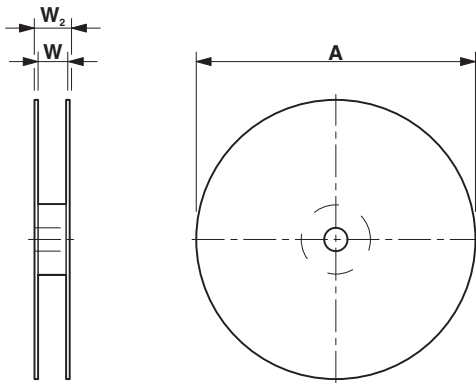

1061704 FP 0,8/ 80-MV 2,65

9 Blister drawing

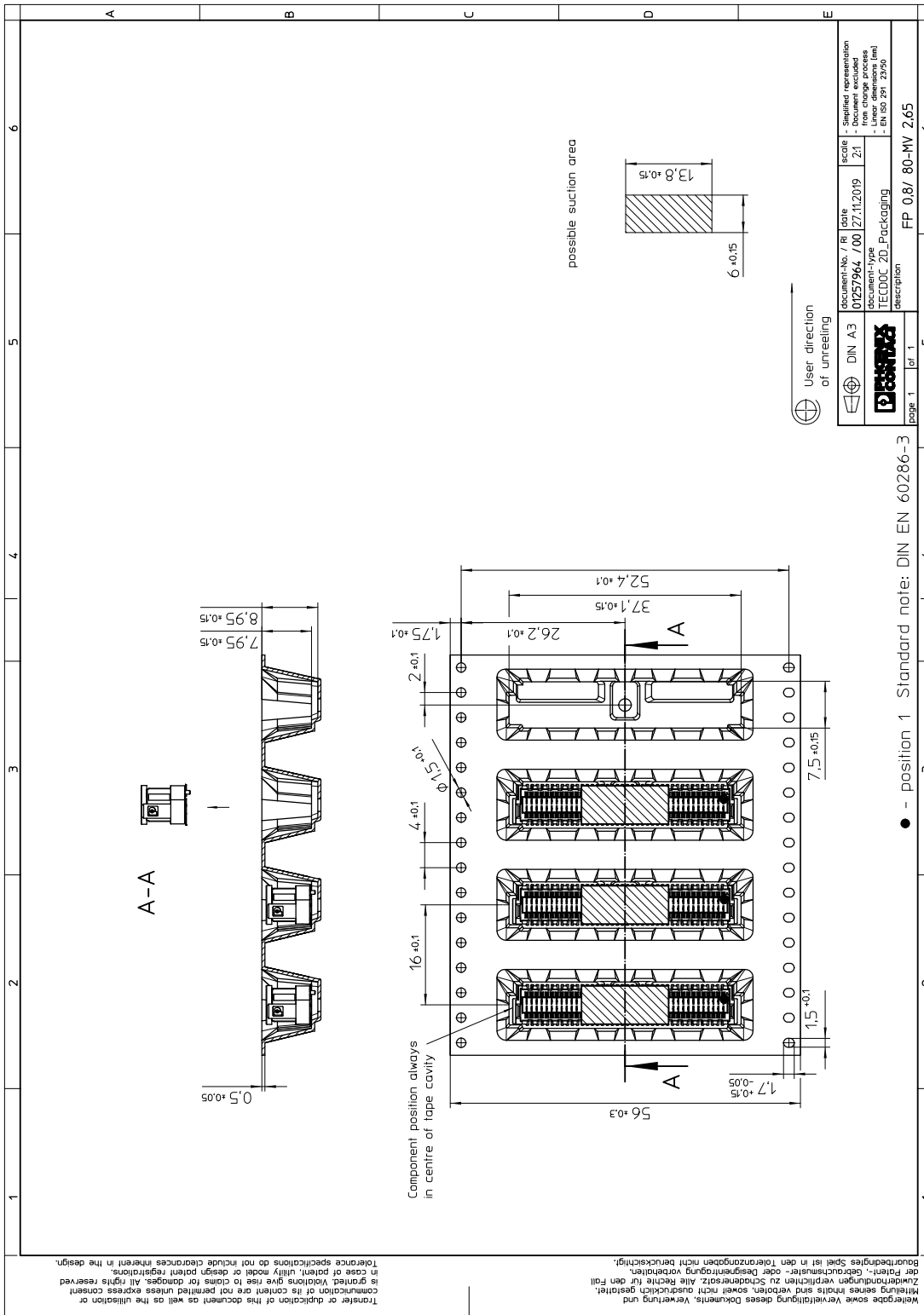

10 Application

10.1 Temperature limit values

| | |
|---|-------------------|
| Ambient temperature (storage/transport) | -40 °C ... 70 °C |
| Ambient temperature (assembly) | -5 °C ... 100 °C |
| Ambient temperature (operation) | -55 °C ... 125 °C |

11 General tests

11.1 Specification

| | |
|--|---------------------------|
|  | |
| Brief description | Board-to-board connectors |

1061704 FP 0,8/ 80-MV 2,65**12 Mechanical tests****12.1 Insertion and withdrawal force per contact**

Insertion and withdrawal force per contact $\leq 0.6 \text{ N}$

12.2 Service life

Specification IEC 60512-9-1:2010-03 (following)

Service life 500 Insertion/withdrawal cycles, Performance level 1

1061704 FP 0,8/ 80-MV 2,65**13 Electrical tests****13.1 Electrical data**

| | |
|--------------------------|-----------------------------|
| Nominal current at 20 °C | 1.7 A (52-pos.) |
| Test voltage | 500 V AC IEC 60512-4-1:2003 |

13.2 Air and creepage distances

| | |
|---|---------|
| Minimum value for clearance and creepage distance | 0.25 mm |
|---|---------|

1061704 FP 0,8/ 80-MV 2,65**14 Current carrying capacity/derating curves****14.1 Insulation resistance**

| | |
|-----------------------|---------------------------------|
| Insulation resistance | ≥ 5 GΩ, (IEC 60512-3-1:2002-02) |
|-----------------------|---------------------------------|

14.2 forward resistance

| | |
|--------------------|---------------------------------|
| Contact resistance | ≤20 mΩ, (IEC 60512-2-1:2002-02) |
|--------------------|---------------------------------|

14.3 Vibration test

| | |
|------------------------|-------------------------------------|
| Specification | IEC 60068-2-6:2007-12 |
| Result | Test passed |
| Frequency | 10 - 2000 - 10 Hz |
| Sweep speed | 1 octave/min |
| Amplitude | 1.5 mm (10 - 60.1 Hz) |
| Acceleration | 200 m/s ² (58 - 2000 Hz) |
| Test duration per axis | 2.5 h |
| Test directions | X-, Y- and Z-axis |

Note

14.4 Shock test

| | |
|--------------------------------|-----------------------------------|
| Specification | IEC 60068-2-27:2008-02 |
| Result | Test passed |
| Pulse shape | Semi-sinusoidal |
| Peak acceleration | 490 m/s ² |
| Shock duration | 11 ms |
| Number of shocks per direction | 3 |
| Test directions | X-, Y- and Z-axis (pos. and neg.) |

1061704 FP 0,8/ 80-MV 2,65

15 Approvals / Certificates

1061704 FP 0,8/ 80-MV 2,65**16 Commercial Data**

| | |
|--------------------|--|
| Order No. | 1061704 |
| Type | FP 0,8/ 80-MV 2,65 |
| Pieces per package | 250 |
| Net weight | 5.2 g |
| GTIN | 4055626715889 |
| | Information that applies locally, see link on page 1 |
| Country of origin | Information that applies locally, see link on page 1 |

1061704 FP 0,8/ 80-MV 2,65

17 Combination tests

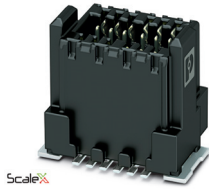

Scale%
FP 0,8/...-MV 2,65

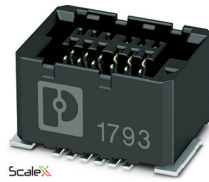

Scale%
FP 0,8/...-FV 4,85



Scale%
FP 0,8/...-FV 7,85

| Mechanical tests | | | | |
|-----------------------------------|-------|-------|--|--|
| Durability tests | | | | |
| Contact resistance R ₁ | 20 mΩ | 20 mΩ | | |
| Insertion/withdrawal cycles | 500 | 500 | | |
| Contact resistance R ₂ | 20 mΩ | 20 mΩ | | |
| Thermal tests | | | | |