

SEZIONE A-A

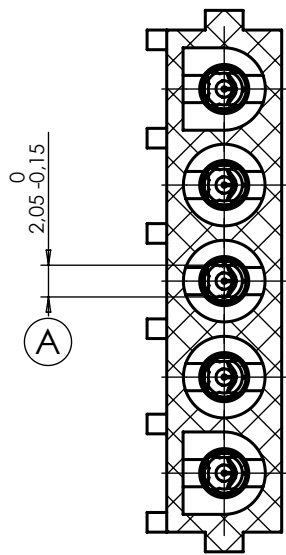

SEZIONE B-B

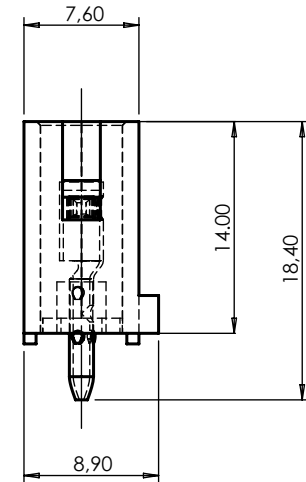
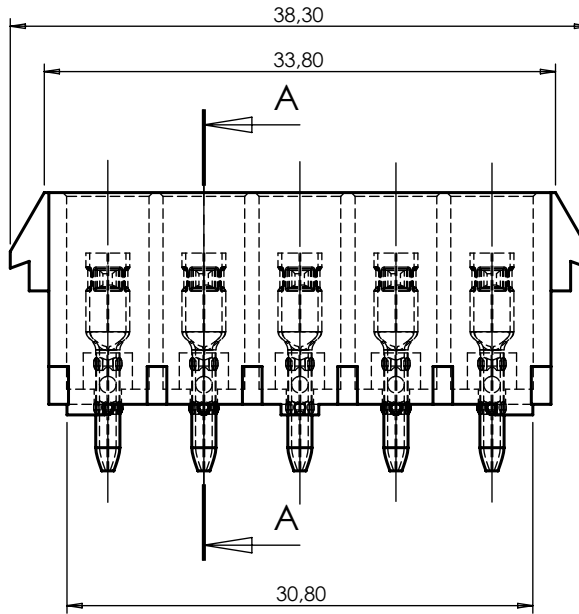
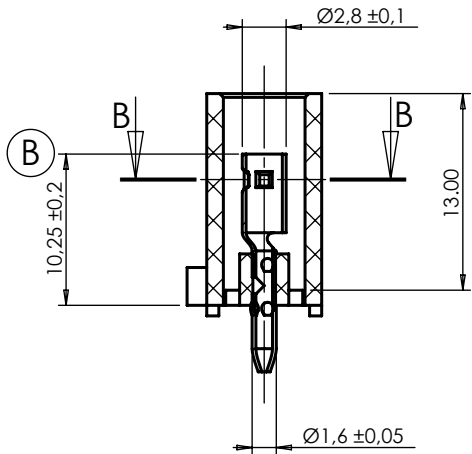
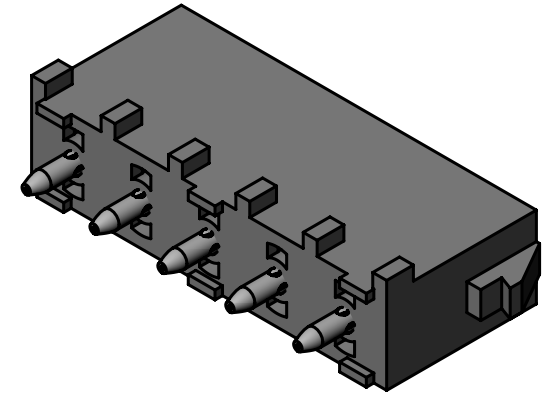
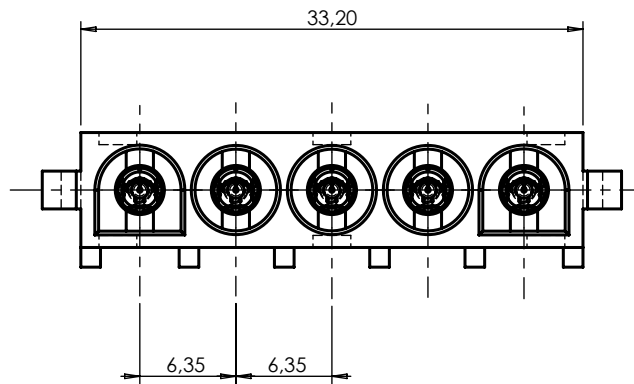

DIMENSIONS WITHOUT TOLERANCES			CS-LK05PCB/F	PA66 UL94 V-2
A ±2°	0 - 6	±0.1	CS-LK05PCB/FV0	PA6/66 UL94 V-0
	6 - 30	±0.2	CS-LK05PCB/FSTY	PA46 UL94 V-2
	> 30	±0.3	CS-LK05PCB/FV0750NF	PA66 UL94 V-0 GWIT 775
			CS-LK05PCB/F-G	PA6 UL94 V-2 GWIT 775
			PART NUMBER	MATERIAL

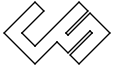
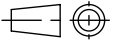
1	Aggiornato cartiglio e aggiunto quote A e B		26-06-2019
INDEX	MODIFICATION		DATE
 <p>CS S.r.l. 20063 CERNUSCO S/N - VIA COMO, 11 TEL +39.02.9210.7404 - FAX +39.02.9210.0217 http://www.csconnectors.com - e-mail: info@csconnectors.com</p>			
CHECKED BY Stefano Galimberti		DATE 26-06-2019	DESIGN UNITS METRIC
DRAWN BY Luca Viscardi		DATE 26-06-2019	WEIGHT (g) 2.43
CAD REFER Y:\dis\cs\lk\05vie\pcb\		SIZE A4	SCALE 2:1
INDEX 0 07-03-2002			
BASE CODE CS-LK05PCB/F	DESCRIPTION Giunto 5 vie per scheda circuito stampato term. femmina serie LK		