



Main

Range of Product	Telemecanique Capacitive proximity sensors XT
Sensor Type	Capacitive proximity sensor
Product Specific Application	Detection of insulated or conductive materials
Sensor name	XT1
Sensor design	Cylindrical M30
Size	70 mm
Body type	Fixed
Detector flush mounting acceptance	Flush mountable
Material	Metal
Enclosure Material	Nickel Plated Brass
Type of output signal	Discrete
Wiring Technique	4-wire
[Sn] nominal sensing distance	0.39 in (10 mm)
Discrete output function	1 NC + 1 NO
Output circuit type	DC
Discrete output type	PNP
Electrical connection	Male connector M12, 4 pins
[Us] rated supply voltage	24 V DC reverse polarity protection
Maximum delay response	5 ms
IP degree of protection	IP67 conforming to IEC 60529 IP67 conforming to IEC 60947-5-2

Complementary

ISO thread	M30 x 1.5
Detection face	Frontal
[Sa] assured operating distance	0.00...0.28 in (0...7.2 mm)
Adjustment zone	0.08...0.79 in (2...20 mm)
Differential travel	< 0.2 x Sr
Repeat accuracy	< 0.1 x Sr
Status LED	Output state indication 1 LED yellow)
Supply voltage limits	12...30 V DC
Maximum residual current	0.1 mA open state
Protection Type	Short-circuit protection
Switching frequency	<= 150 Hz
Maximum voltage drop	<2 V closed)
Current consumption	< 15 mA
Maximum delay first up	30 ms
Maximum delay recovery	5 ms
Maximum switching current	200 mA
Marking	CE
Setting-up	Sensitivity by potentiometer
Threaded length	2.17 in (55 mm)
Length	2.76 in (70 mm)
Net Weight	0.33 lb(US) (0.15 kg)

Environment

Standards	EN/IEC 60947-5-2
Product Certifications	cETLus
Ambient air temperature for operation	-13...158 °F (-25...70 °C)
Vibration resistance	10 gn 1 mm 10...55 Hz)IEC 60068-2-6
Shock resistance	30 gn 11 ms IEC 60068-2-27
Resistance to electrostatic discharge	4 KV contact IEC 61000-4-2 8 kV air IEC 61000-4-2
Resistance to electromagnetic fields	2.74 V/m (3 V/m) IEC 61000-4-3
Resistance to fast transients	2 kV IEC 61000-4-4

Ordering and shipping details

Category	22490 - SENSORS-ULTRASONIC (XX5,6)
Discount Schedule	DS2
GTIN	3389119025942
Nbr. of units in pkg.	1
Package weight(Lbs)	5.43 oz (154 g)
Returnability	No
Country of origin	DE

Packing Units

Unit Type of Package 1	PCE
Package 1 Height	1.34 in (3.4 cm)
Package 1 width	1.18 in (3 cm)
Package 1 Length	3.23 in (8.2 cm)
Unit Type of Package 2	S02
Number of Units in Package 2	60
Package 2 Weight	21.66 lb(US) (9.825 kg)
Package 2 Height	5.91 in (15 cm)
Package 2 width	11.81 in (30 cm)
Package 2 Length	15.75 in (40 cm)
Package 3 Height	5.91 in (15 cm)

Offer Sustainability

California proposition 65	WARNING: This product can expose you to chemicals including: Diisononyl phthalate (DINP), which is known to the State of California to cause cancer, and Di-isodecyl phthalate (DIDP), which is known to the State of California to cause birth defects or other reproductive harm. For more information go to www.P65Warnings.ca.gov
REACH Regulation	REACH Declaration
EU RoHS Directive	Compliant EU RoHS Declaration
Mercury free	Yes
RoHS exemption information	Yes

Contractual warranty

Warranty	18 months
----------	-----------

Dimensions

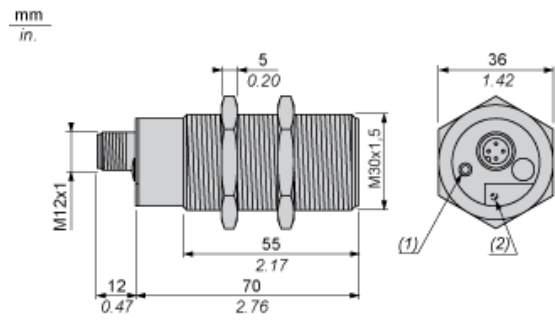

- (1) LED
- (2) Potentiometer beneath protective flap

Setting-up

Minimum Mounting Distances (mm)

Side by side

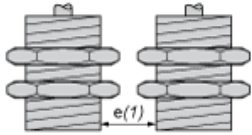

$e(1) \geq 0$

Face to face

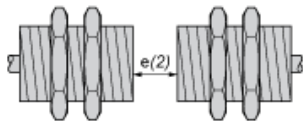

$e(2) \geq 22$

Facing a metal object

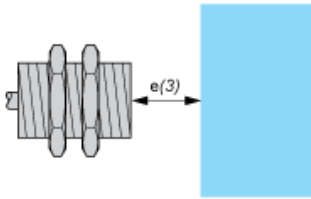

$e(3) \geq 20$

Mounted in support

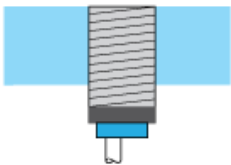

Fixing nut tightening torque: 40 N.m

Adjustment

Sensitivity Adjustment

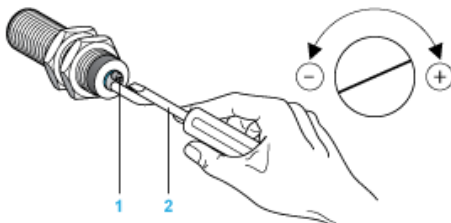

- (1) Adjustment potentiometer
- (2) Screwdriver (included with sensor)

Wiring Diagram

Connector

M12 connector

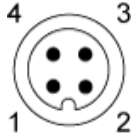

4-wire DC, PNP NO + NC Output, M12

