

RPC-1.85

Mismatch
Plug

08S150-060S3

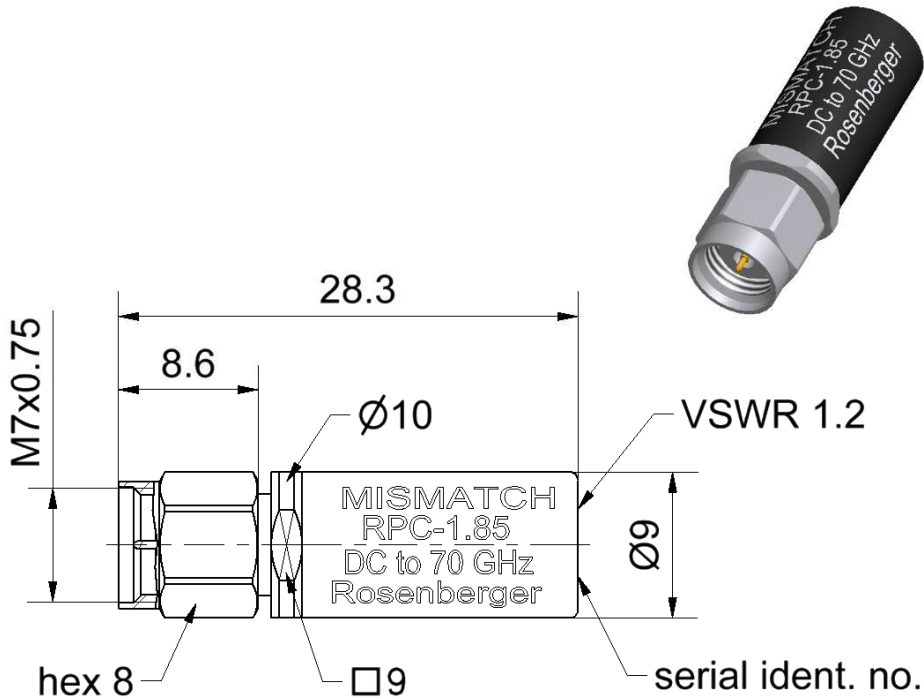

All dimensions are in mm; tolerances according to ISO 2768 m-H

Interface

According to IEC 61169-32
Mechanically compatible with RPC-2.40

Documents

Application note AN001 "Calibration Services"

Material and plating

Connector parts

	Material	Plating
Center contact	Beryllium copper	Gold, min. 1.27 µm, over nickel
Outer contact	Stainless steel	Passivated
Coupling nut	Stainless steel	Passivated
Dielectric	PS	
Substrate	Al ₂ O ₃	

Electrical data

Frequency	DC to 70 GHz
Return loss	≥ 1.2 ± 0.09, DC to 26.5 GHz ≥ 1.2 ± 0.15, 26.5 GHz to 70 GHz
DC Resistance	60 Ω ± 0.30 Ω
Power handling (at 25 °C, sea level)	≤ 0.5 W, derated linearity by 0.005 W/K

Mechanical data

Mating cycles	≥ 500
Maximum torque	1.65 Nm
Recommended torque	0.90 Nm
Gauge	0.00 mm to 0.03 mm

Environmental data

Operating temperature range ¹	+20 °C to +26 °C
Rated temperature range of use ²	0 °C to +50 °C
Storage temperature range	- 40 °C to +85 °C

RoHS compliant

¹ Temperature range over which these specification are valid.

² This range is underneath and above the operating temperature range, within the mismatch is fully functional and could be used without damage.

Declaration of calibration options

Factory Calibration

Standard delivery for this calibration standard includes a Factory Calibration. The Calibration Certificate issued reports individual calibration results, traceable to national / international standards.

Accredited Calibration

Not available.

For further, more detailed information see application note AN001 on the Rosenberger homepage.

Calibration interval

Recommendation 12 months

Packing

Standard 1 pce in box
Weight 7.2 g/pce

While the information has been carefully compiled to the best of our knowledge, nothing is intended as representation or warranty on our part and no statement herein shall be construed as recommendation to infringe existing patents. In the effort to improve our products, we reserve the right to make changes judged to be necessary.

Draft	Date	Approved	Date	Rev.	Engineering change number	Name	Date
Kerstin Herzog	05.02.08	Markus Müller	11.10.19	e00	19-1910	Marion Striegler	11.10.19
Rosenberger Hochfrequenztechnik GmbH & Co. KG P.O.Box 1260 D-84526 Tittmoning Germany www.rosenberger.de					Tel. : +49 8684 18-0 Email : info@rosenberger.de		Page 2 / 2