

**ADVANTECH**

*Enabling an Intelligent Planet*

# Edge Intelligence Solutions Success Story eBook

6 × Industries | 23 × Cities | 33 × Solutions

# Edge+

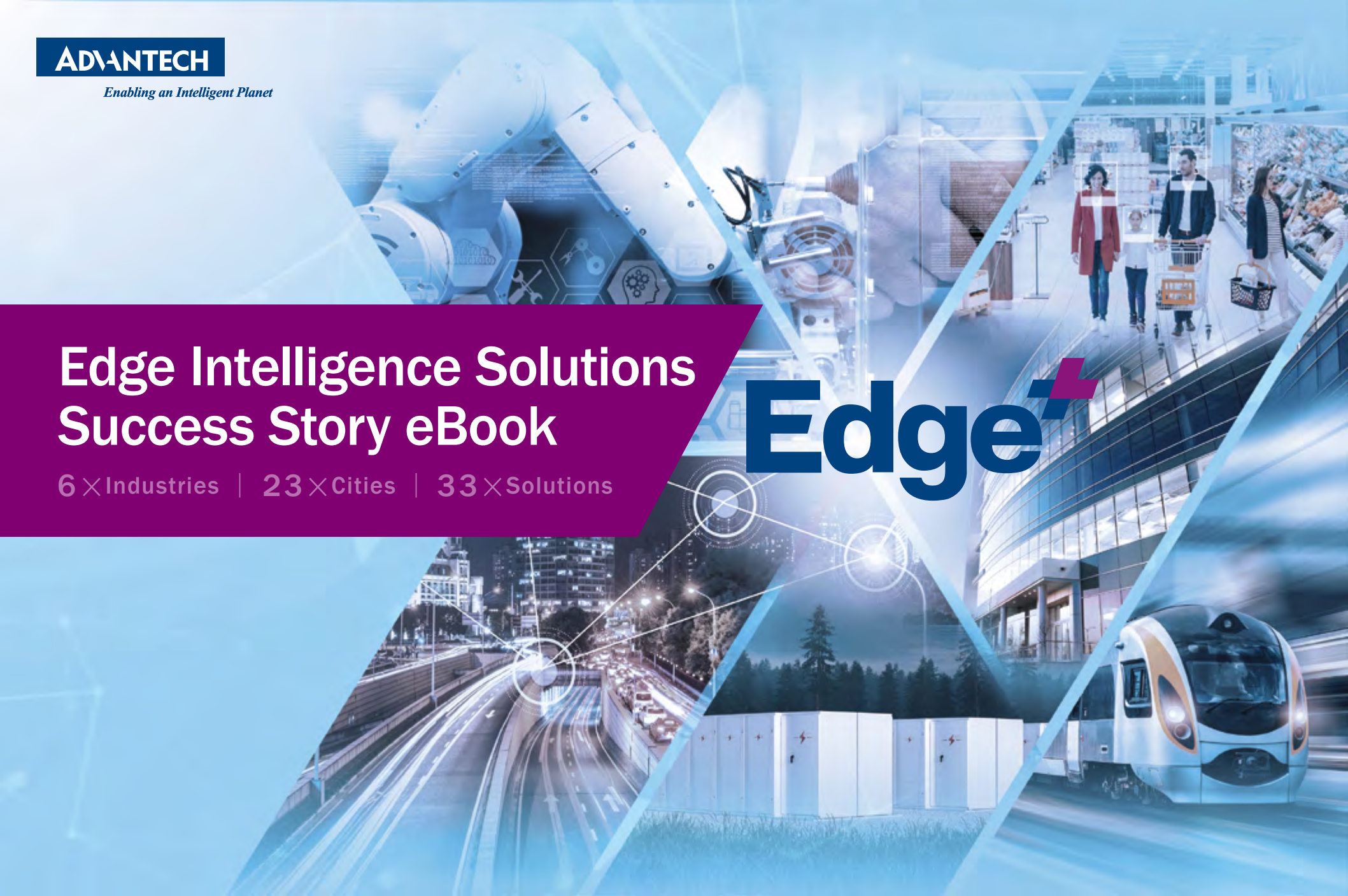

# Table of Content



## ► Factory Automation

- [AI-enabled On-site Production Line Monitoring](#)
- [ePaper Improves Production Line Efficiency](#)
- [Semiconductor Production Monitoring](#)
- [Wireless Solutions Avoids Unnecessary Wiring](#)
- [Automatic Welding Machine Monitoring](#)
- [Digital Transformation in CNC Machine](#)
- [AI-driven Fruit Grading and Inspection](#)
- [AI-powered Pharmaceutical Tablet Inspection](#)
- [High-speed PCB Inspection](#)
- [ePaper Enhances Stock Accuracy in Warehouses](#)
- [Power Substation Inspection Robot](#)



## ► Transportation

- [LTE Technology Powered Public Bike Rental Systems](#)
- [AI-led Smart Parking](#)
- [Riding Service eFiscalization System](#)
- [Digital Signage Advertising in Subway Stations](#)
- [ePaper Visualizes Railway Equipment Maintenance](#)
- [Reliable In-vehicle Systems Improve Road Safety](#)
- [Improve Passenger Experiences and Airport Operation](#)
- [Airport Self Check-in Kiosk](#)



## ► Smart Cities

- [Efficient Remote Control and Monitor Water Gates](#)
- [Real-time Monitoring Water Circulation Systems](#)
- [Remote Fuel Monitoring for Microsite Fuel Stations](#)
- [ePaper- Ultra Low-power Roadside Information Board](#)
- [AI Facial Recognition for School COVID-19 Prevention](#)



## ► Smart Building

- [AI-Driven Video Surveillance for Home & Business](#)
- [Temperature Monitoring Solutions](#)
- [Touchless AI Elevator System](#)



## ► Energy & Mines

- [Remote Underground Coal Mine Safety](#)
- [Centralized Management Smart Energy Storage Systems](#)
- [Energy Storage System Monitoring and Control](#)



## ► Kiosk & Retail

- [24/7 Self-service Lockers](#)
- [Self-Ordering Kiosk in Quick Service Restaurants](#)
- [Digital Signage in Health and Beauty Retailer](#)

## Factory Automation



Region Indonesia

# AI-enabled On-site Production Line Monitoring

Site managers encounter difficulties monitoring conditions within factories. This customer combined an edge AI inference system with IP cameras that monitor operators' movements on factory floors. This system identifies abnormal behavior — such as lingering or working without gloves. In this application, Advantech's AIR-300 collects data from camera video streams installed at each workstation. It conducts real-time AI analysis to detect whether and operators' behavior complies with pre-specified SOPs and relays these results to a central database, where supervisors remotely monitor and analyze the data. This improves results and improves performance and efficiency.

### Benefits:

- High Performance inference system with Intel® Xeon® CPU
- High bandwidth 4 x GbE and max. 20TB storage capacity
- VEGA-340 AI acceleration with power efficient Intel® Myriad™ X VPU

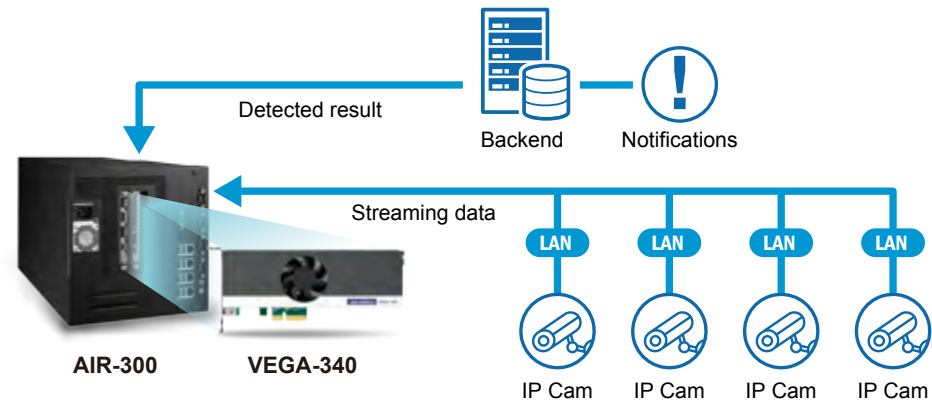



## ePaper Shortens Production Line Communication Threads

Advantech's M9 facility uses around one-hundred factory trolleys to carry incomplete products through different production stages. Operators used to have to memorize which trolley carried which item, when that item entered production, and where that item started/finished. Implementing ePaper devices streamlines this process and makes production more efficient. These solutions also enable managers to measure and control production processes.

### Benefits:

- ePaper devices travelling between different routers stay connected
- Improves production line efficiency and time management
- Reduces inquiry time and error rates by 5% per month

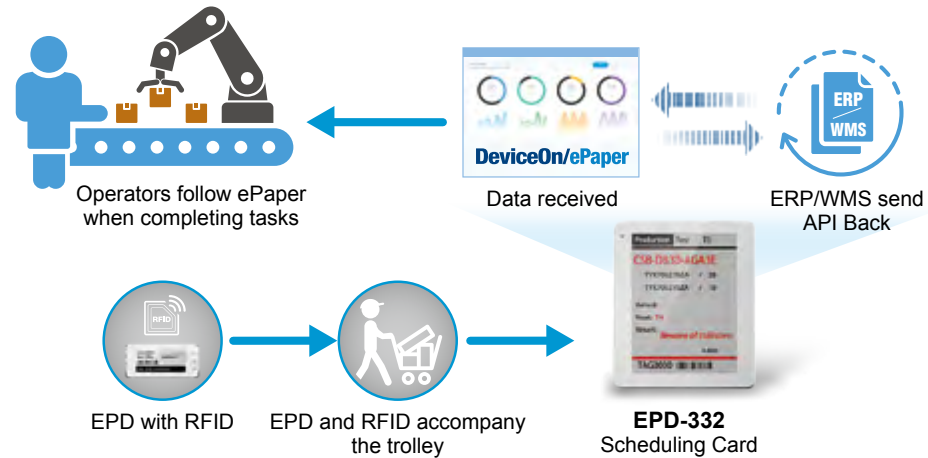

## Monitor Semiconductor Production Air Pressure in Real Time

Semiconductor manufacturing necessitates diffusion equipment with fixed air pressure levels. As such, semiconductor plants rely on centralized air delivery systems for individual production units. These centralized systems are problematic and sometimes deliver inconsistent pressure levels. Individual machinery sets can be independently monitored, but accurately determining air-pressure remains difficult and results in low yield rates. This company sought to remedy the issue by developing a real-time air pressure monitoring system.

### Benefits:

- Digitalizes analog air pressure data for collection and visualization
- Enables real-time air pressure monitoring and prompt detection
- Reduces equipment downtime risks using immediate warning notifications while boosting production capacity and improving yield rates

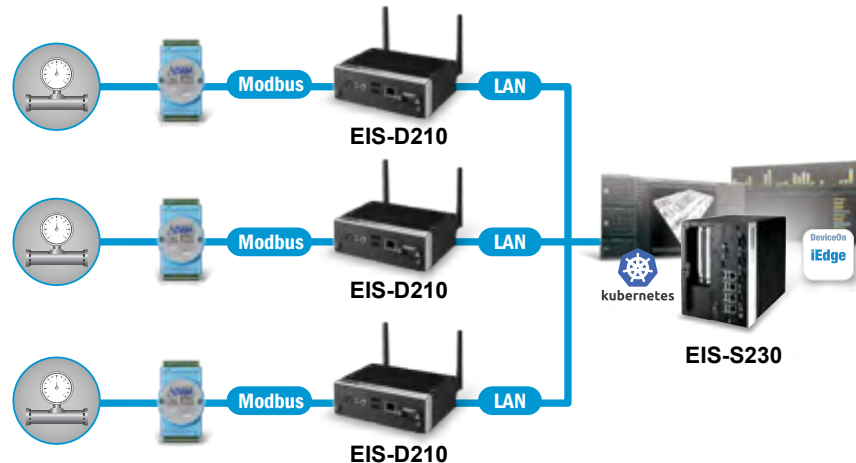

## Wi-Fi Module Enables Vibration Monitoring via Low-wiring Solution

An estimated 40% of factory equipment problems are caused by vibration from rotating machinery. A vibration analysis and diagnosis service provider in Japan previously used an Ethernet based vibration sensor for target monitoring. This sensor required extensive installation and maintenance, necessitating a system with minimal cabling. To this end, the Japanese company began using Advantech's WISE-1530 solution.

### Benefits:

- Easily embedded via M.2 Connector
- Japanese certified Wi-Fi module
- Avoids unnecessary Ethernet wiring

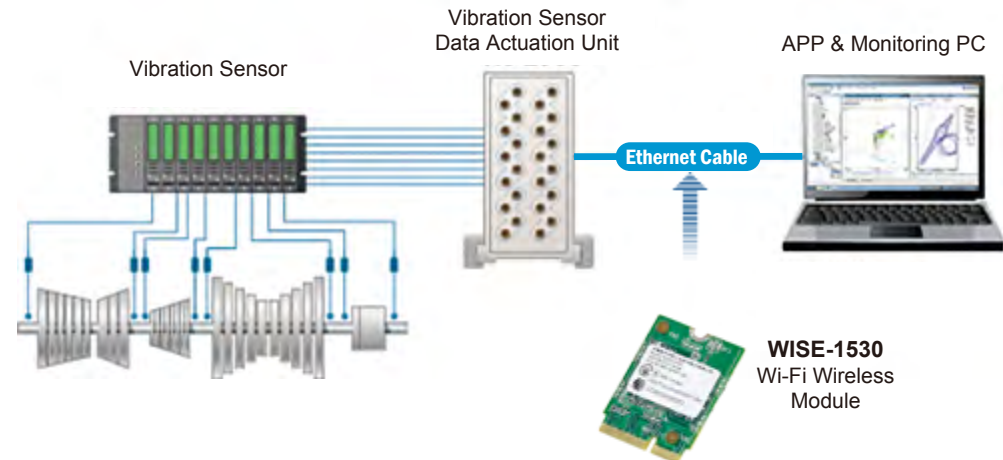
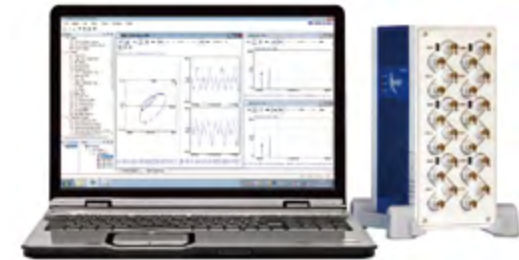



## Automatic Welding Machine Monitoring with Customer-centric Demand

Nogata Seiki, an automobile parts manufacturer, wanted to visualize the operating status of their equipment in order to realize more efficient production processes, implement appropriate human resources training, and reduce maintenance costs. Advantech and its eco-Partners are meeting this challenge by helping them visualize the production process. To this end, they are building a dashboard based on customer requirements using data obtained via PLC in an automatic welder.

### Benefits:

- Eases machine data collection with edge-to-cloud integrated system
- Customer-centric dashboard builder with development tools — NodeRed and Grafana
- Fanless, rugged and highly expandable product designs





## Improving CNC Machine Value and Accelerating Business Transformations

New AIoT technologies enable the retrieval of equipment status and production information from CNC machines. This data can be sent to the cloud for analysis where it helps improve overall equipment effectiveness (OEE), reduces operational costs, and empowers digital transformation. The company in this particular case decided to develop a CNC machine remote monitoring management solution aimed at improving after sales service and efficiency. This system reduces the labor, resource, and time costs accrued by maintenance.

### Benefits:

- Powerful data visualization features enable swift dashboard creation in the cloud or at the edge, and fulfills diverse information requirements for relevant staff
- Remote CNC machine monitoring, health diagnosis, and real-time troubleshooting
- Flexible connection solution helps clients receive equipment data for value-added services and streamlined maintenance operations

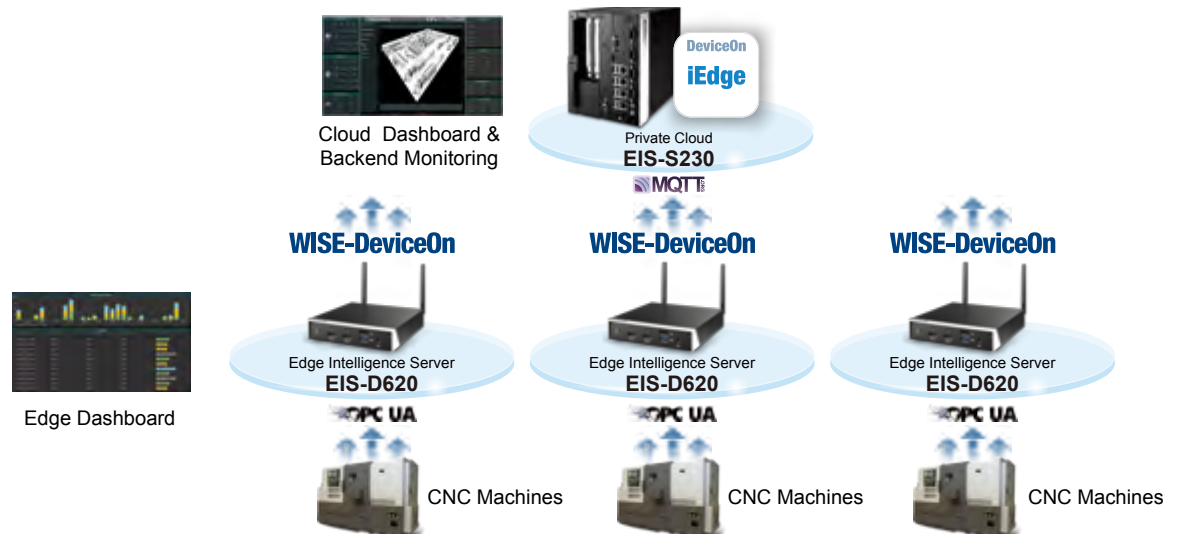



## Factory Automation

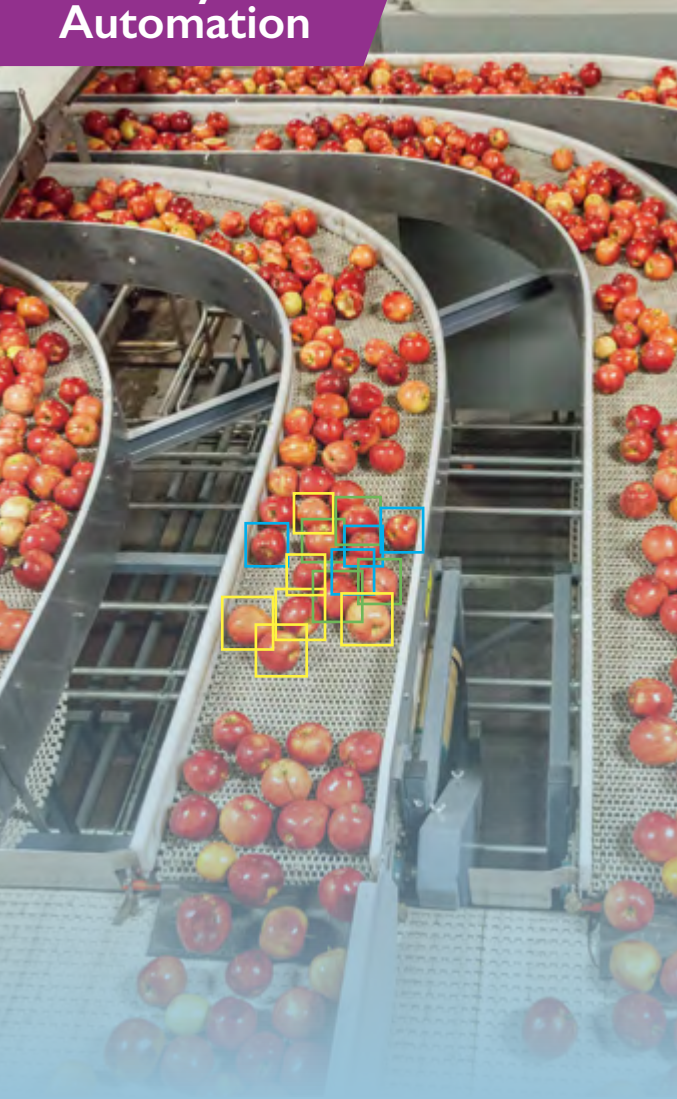

Region

China

# AI-driven Fruit Grading and Inspection

Traditional fruit grading and inspection — with human eyesight or automated grading machines — is time-consuming, labor-intensive, and costly. Fortunately, innovative AI technologies improve inspection efficiency and precision. Fruit sent to grading machines are scanned by IP cameras and sorted according to appearance, size, and color according to an AI model. This fruit is then inspected using other methods to ensure quality. This customer leveraged an Advantech AIR-101 AI inference system and VPU vision processor for fruit grading. This reliable system provided efficient visual computing performance, multiple I/O interfaces, and DIN rail design to deliver high precision grading and allow customers to easily deploy.

### Benefits:

- Low power consumption and high scalable VPU, more affordable than GPU and FPGA solutions
- Edge AI Suite and Intel® OpenVINO™ toolkit accelerate deployment
- Rich I/O interface for various connected devices — including cameras, scale sensors, code scanners, and printers

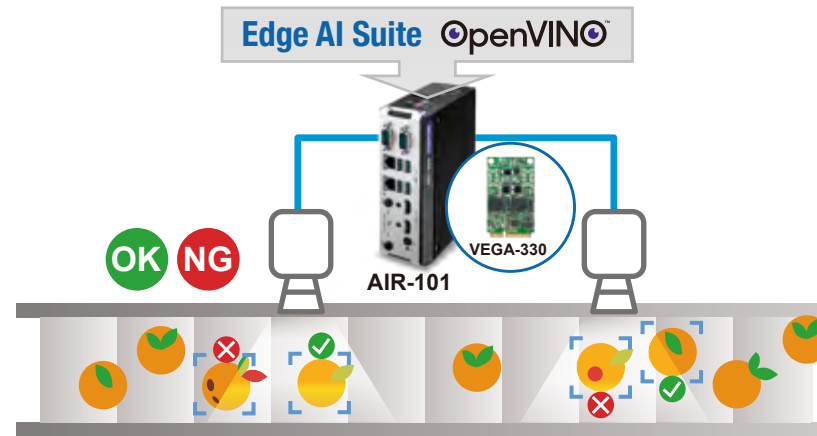

## AI-powered Automatic Pharmaceutical Tablet Inspection

Traditional pharmaceutical industry vision-based systems may not be capable of identifying new products/models, or detecting defects in products with similar colors/shapes. AI technology presents a solution to these problems. Our customer used the Advantech AIR-300 AI system with multivariate analysis algorithms to inspect large numbers of tablets with a high degree of accuracy. AIR-300 processes and analyzes large volumes of spectral data captured from hyperspectral cameras at high scan rates, enabling it to identify defects in real-time. AIR-300 supports the deployment of newly trained/retrained models for continuous optimization.

### Benefits:

- Powerful Intel Xeon CPU and an NVIDIA GPU card enable simultaneous inspection of multiple spectral bands at high speeds
- DDR4 SO-DIMM memory supports up to 32GB
- Supports up to 260W PCIe x16 high power GPU card

### Multivariate analysis

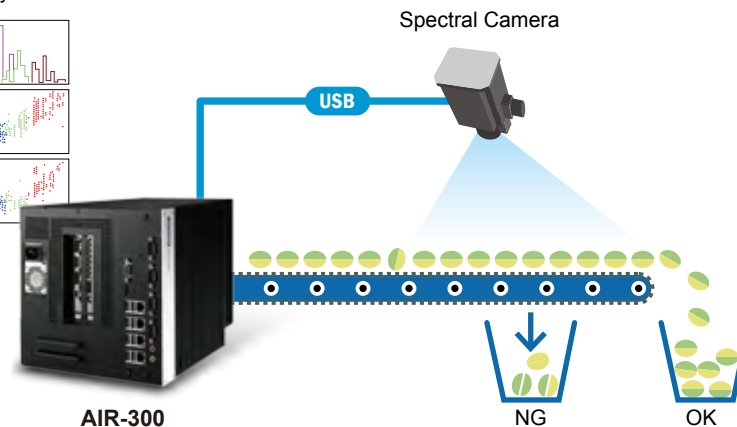
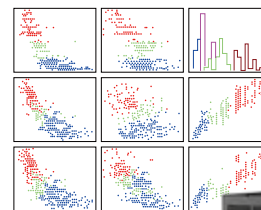

## High-speed PCB Inspection

IC surface marking inspection uses image processing technology and a trained database of characters to recognize anomalies on complex parts and surfaces without the use of manual labor. As the controller of an PCBA IC marking inspection system, ARK-1551 supports connection with high speed, high resolution vision camera and servo motor. It reliably and precisely processes multi-angle images while simultaneously conducting position alignment via a servo motor and performing OCR inspection and label printing. These capabilities improve manufacturing efficiency and quality control.

### Benefits:

- Provides the computing power needed to process high quality images and multitask
- Supports diverse I/O for various devices and peripherals
- Supports fanless operation and wide range power input for factory environments

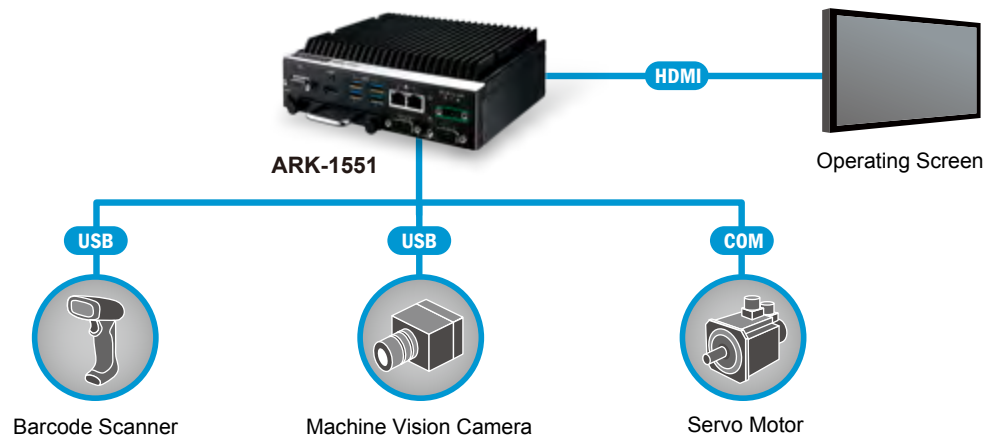



## ePaper Solution Promptly Coordinates Visualization, Verification, and Stock Information

This customer's facility had about 1500 storage locations — forcing operators to waste time looking for materials, and resulting in incorrect stock numbers. ePaper solutions allowed this customer to increase efficiency and stock management accuracy by enabling visualization and RFID. Once collected, data was analyzed via Advantech's DeviceOn/ePaper solution.

### Benefits:

- Displays real-time inventory by integrating RFID technology
- Visualizes LED and picker information to improve picking process
- DeviceOn/ePaper enables operators to provide fast, efficient feedback on requests

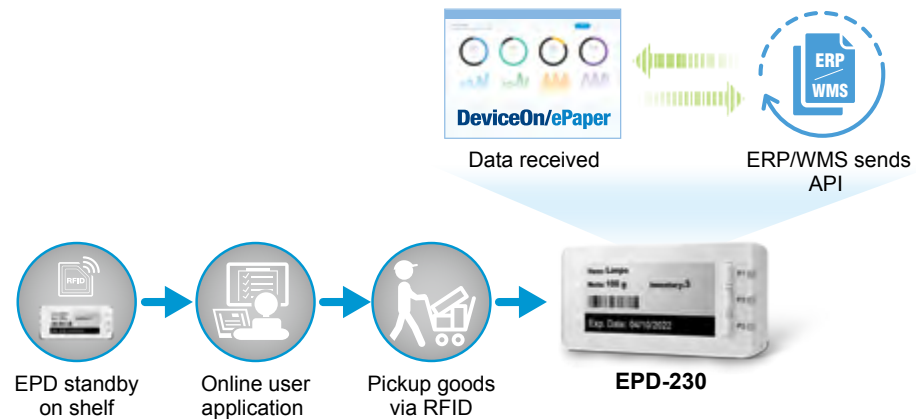

## Power Substation Inspection Robot

The proliferation of disparate unmanned power substations has made demands for inspection robots increasingly urgent. Advantech's ARK-2250L is used as the brain of this battery-powered inspection robot controller. It enables this robot to use a high-resolution CCD camera, a thermal infrared imager, and a laser radar — enabling 24/7 remote monitoring. In addition, this robot uses alerts to notify relevant personnel upon detecting an abnormality. Information such as inspection data and location is transferred to control centers via 5G, 4G, or Wi-Fi wireless channels. This reduces downtime and enables preventative maintenance.

### Benefits:

- High-performance Intel® processor quickly processes large volumes of data
- Multiple I/O connections for various sensor and device integration
- Supports 5G/4G/Wi-Fi modules
- Fanless design with wide operating temperature support (-20 ~ 60 °C/-4 ~ 140 °F)

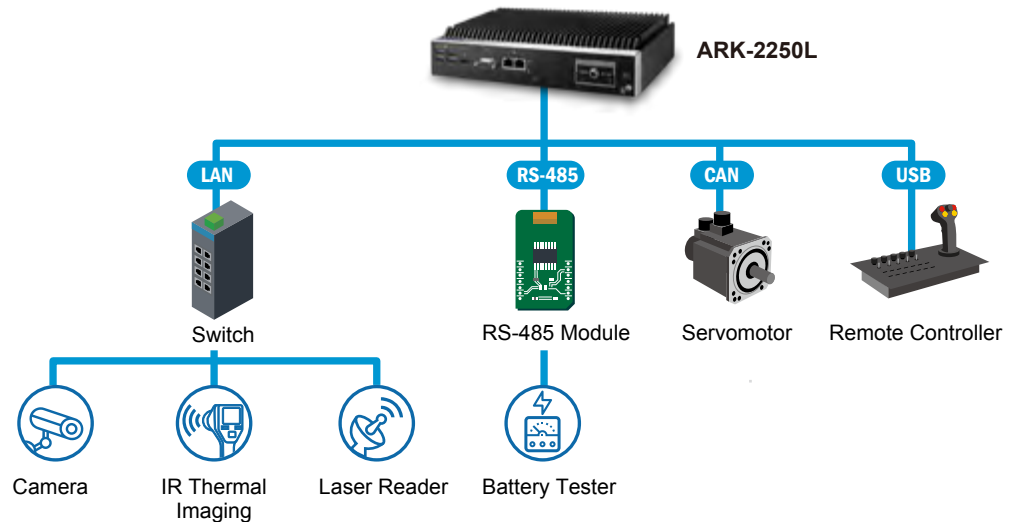

## LTE Wireless Technology Enhances Stable Connectivities within Public Transportation Systems

Public transportation agencies seeking to leverage bike rental systems need to consider the number of bikes, stations, and the control centers. Wireless technology effectively reduces the cost of these systems and increases their usage. Advantech's AIW-344 LTE Wireless Modules deliver wide temperature support and stable connectivity to public bike rental systems.

### Benefits:

- High-performance IPC via Advantech ARK-2230L and 4G LTE AIW-344
- HW/SW/RF total solution and integration services
- Solution based selling eases Design-in process

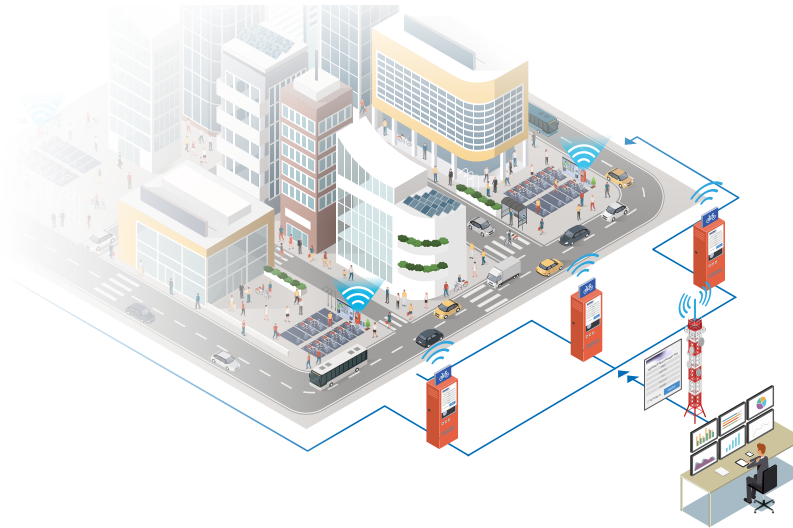

**AIW-344**  
LTE Wireless Module



**ARK-2230L**  
Modular Fanless Computer



## AI-driven License Plate Recognition Improves Parking Lot Operation

Traditional rule-based license plate recognition can fail due to obscure camera angles or weak ambient lighting. AI technology helps solve these problems. Advantech's AIR-101 AI system precisely scans and analyzes vehicle plates and provides automatic parking lot access. This system uses built-in Intel® Movidius™ VPUs and AI algorithms provided by our ISV partner. These quickly conduct accurate license plate recognition that improves parking experiences and lot efficiency.

### Benefits:

- Intel Atom® CPU with two Intel® Movidius™ VPUs optimize computing workloads and saves costs
- Local 3rd party ISV vendor software cooperation
- Supports wide range power input and temperatures

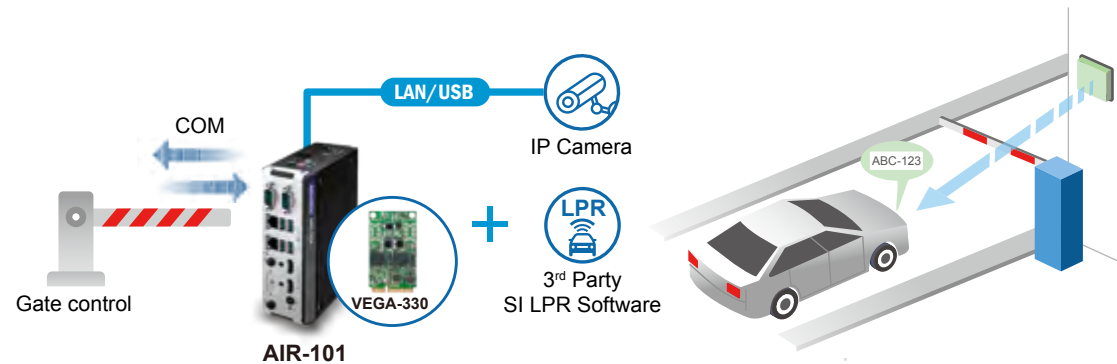

# Transportation



Region Europe

## Riding Service eFiscalization System

Our end customer is a leading ride service provider. They were seeking an e-fiscalization system capable of installation within their fleet partners' cars. This system needed to collect transaction details in real-time in response to local financial regulation. Advantech ARK-1123 provides a software and hardware integrated platform that allows seamless on-boarding, provisioning, and OTA functions. The ARK-1123 automatically connects to the network following activation. The integrated device will automatically find the DeviceOn services used on Microsoft Azure cloud, and install the latest software. In addition, administrators can monitor the operating status of each ARK-1123 and optimize operational efficiency.

### Benefits:

- Sufficient computing performance for real-time data collection and transmission
- Pre-installed DeviceOn software for on-boarding, provisioning and OTA functions
- Compact design, industrial grade quality, and low power consumption capabilities for in-vehicle applications

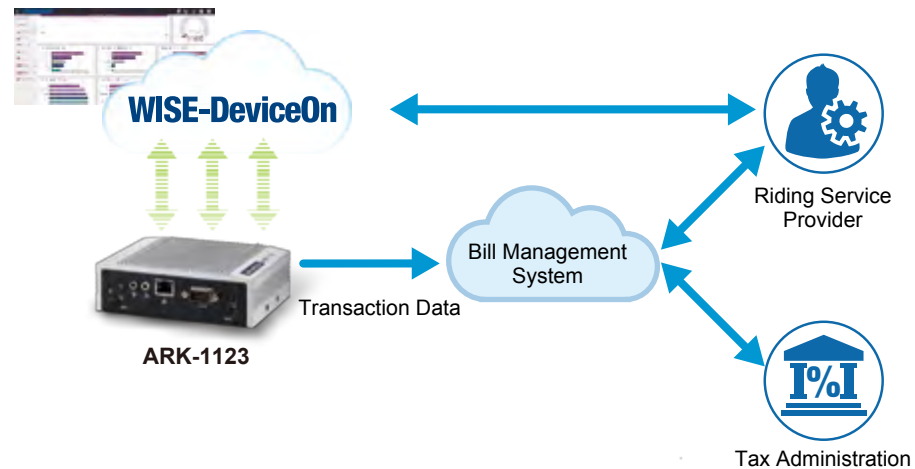



## Increasing Passenger Engagement and Retail Sales in Subway Stations

In Japan, digital signage displays are deployed everywhere in subway stations and underground shopping malls to provide traveler information and broadcast advertising. Advantech's DS-100 digital signage player was selected for this project because of its ultra-compact design, optimized graphics, and high cost-effectiveness. The fanless signage player is powered by an ARM Cortex-A72 processor and equipped with Android OS, which facilitated easy integration and wide-scale installation.

### Benefits:

- Cost-effective ARM-based solution
- Ultra compact design for space limited installation
- Supports Android 7.1



## ePaper Helps Improve Equipment Maintenance Process

A rail transportation authority in China needed to maintain a diverse selection of equipment. Using ePaper devices to provide dynamic QR codes enables engineers to organize maintenance schedules quickly. ePaper solutions also enable records and manuals to be displayed and accessed in real time — reducing costly unexpected stoppages.

### Benefits:

- Maintenance execution rate increased by 100%
- Dynamic QR codes help engineers keep track of maintenance
- ePaper devices visualize maintenance records and manuals

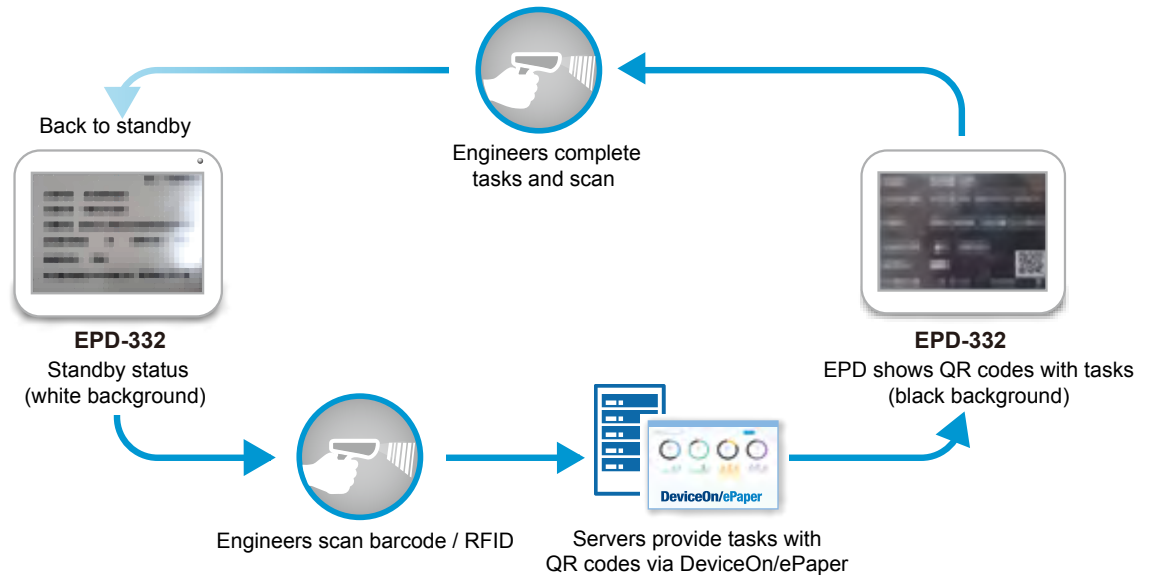

## Reliable In-Vehicle Systems Improve Road Safety

Public transportation is an essential component of modern economies. An Australian service provider was looking for ruggedized, reliable, and internationally certified equipment capable of operation in harsh environments. Advantech provided multi-extension slots for 4G LTE, Wi-Fi, and GPS modules that enable real-time monitoring and tracking systems. These features enhanced train safety and provided abnormality-warning functions.

### Benefits:

- Adheres to EN50155, EN50121, IEC61373 certifications
- Up to 8ch x 1080p @30fps IP camera connection for video surveillance
- Supports dual LTE Cat6 300/50Mbps bandwidth
- Supports dual Wi-Fi extension as hot spot point
- Ultra wide operating temp. -40 ~70 °C (-40 ~ 158 °F)



## Improve Passenger Experiences and Airport Operation

FIDS utilizes multiple monitors to deliver up-to-date information and services to passengers. This system uses Advantech's DS-211 to simultaneously convey flight information and infotainment services. Its OPS slot-in design reduces space requirements while lowering deployment and field maintenance costs. DS-211 is powered by ARM Cortex low power, high-performance processors that ensure 24/7 operation. It uses an M.2 interface and dual LAN for internet connectivity and a RS-232 for remote management.

### Benefits:

- Slot-in cable design simplifies installation and maintenance
- Low power design meets airport energy demands of and lowers operational costs
- Professional FIDS industry experience

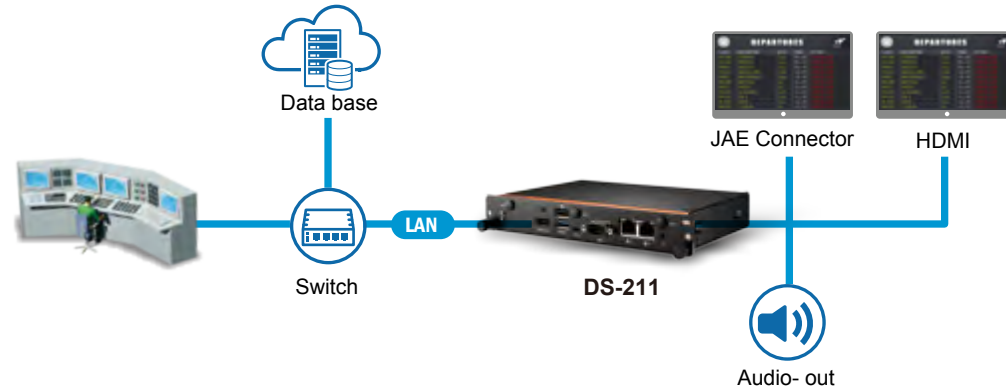

## Airport Self Check-in Kiosk

Designing an airport self-service check-in kiosk is a complex and multifaceted process. Such devices require the combination of several input/output devices within a large slim metal box. These boxes contain controller PCs, LCD panels, cameras, cellular modems, barcode scanners, and diverse peripherals, all supplied by a consistent power supply. ARK-1551 supports high bandwidth peripheral devices and provides flexible I/O expansion — making it the natural choice for this application. Indeed, its slim design enables easy integration within the space-limited kiosk cabinet.

### Benefits:

- Compact size system with versatile I/O ports
- Powerful Core i computing performance
- Stable and reliable fanless system avoids issues caused by noise and dust

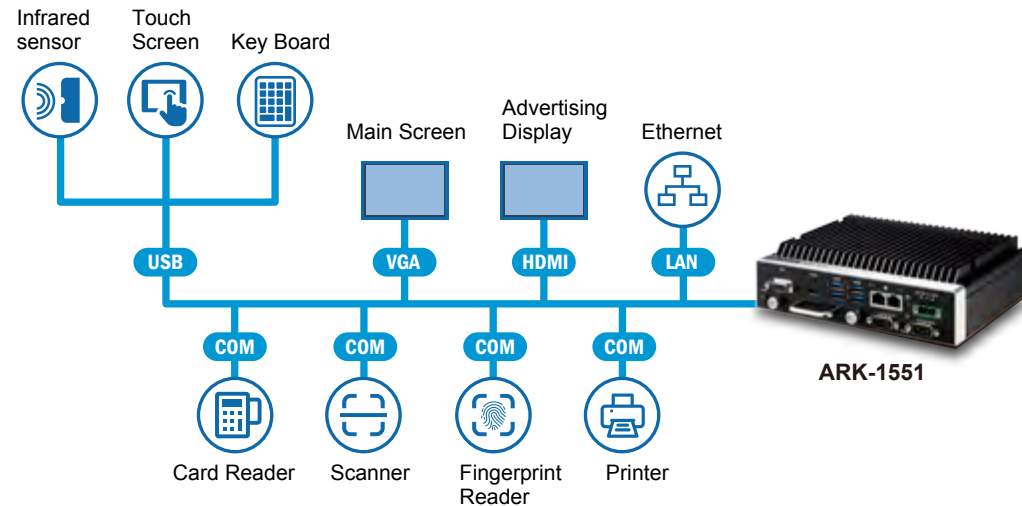

## Efficient Remote Control and Monitor Water Gates

Sluice gates in Nogata City, Fukuoka Prefecture, used to require workers to open them manually. This city decided to introduce AI technology that remotely controls water gates, improving efficiency and reducing labor costs. Advantech cooperates with SI to monitor water level changes and control gates using DeviceOn/iEdge. Advantech's AIR-100 uses AI computing to record water velocity and flow direction. This helps avoid flooding and other disasters.

### Benefits:

- Fully integrated system collects and analyzes sensor information and creates dashboard
- Make informed water level predictions and smart control water gates using AI models
- Built-in Intel® Movidius™ Myriad™ X MA2485 VPU up to 4 TOPS
- Reduce human resources requirements

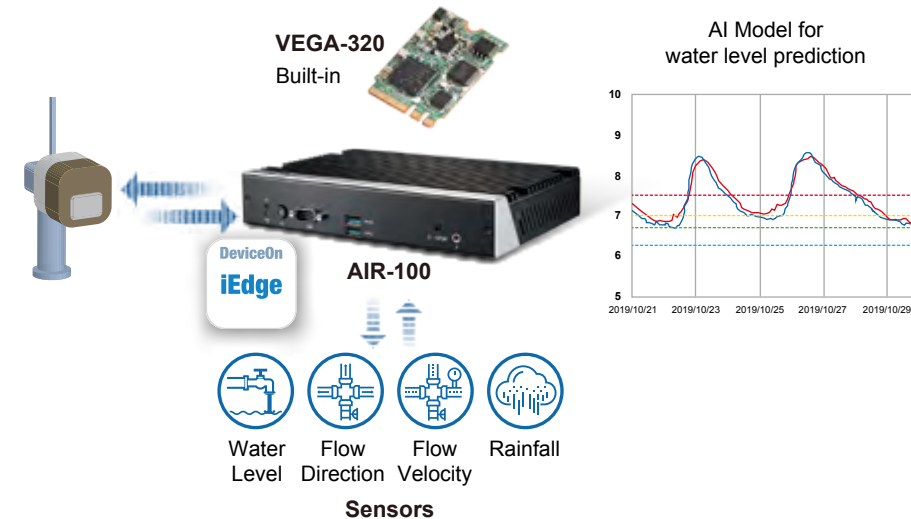

## Real-time Monitoring Water Circulation Systems

Using IoT technology to simulate and optimize collected information helps the energy industry monitor, diagnose, and augment water circulation systems and heat exchange equipment. In addition, it provides real-time operation optimization and adjustment, enables the scientific management of circulating water, rations water use, and reduces fouling rates.

### Benefits:

- Reduce human errors and increase efficiency with integrated monitoring system
- Supports multiple communication protocols, data collection, and dashboard visualization
- Real-time remote monitoring and control for equipment at the edge

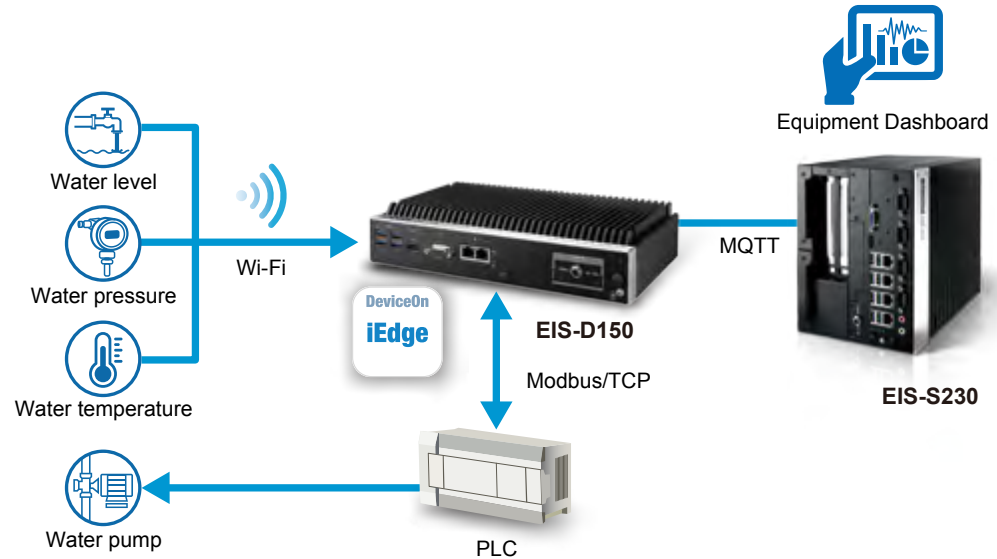

## Remote Fuel Monitoring for Microsite Fuel Stations

Indonesia is the largest motor vehicle market in Southeast Asia. Therefore providing fuel stations across the country — including remote areas — is crucial. Advantech's customer adopted the ARK-1220L solution in their container fuel station. The ARK-1220L controller collects fuel storage and consumption data from the site and sends it to a central office. This enables the fuel service company to optimize deliveries and use detailed visualization tools.

### Benefits:

- Small footprint with DIN-rail mount for easy installation into cabinets with limited space
- Essential I/O for the connecting to various devices
- Compatibility with wireless modules to send data over internet

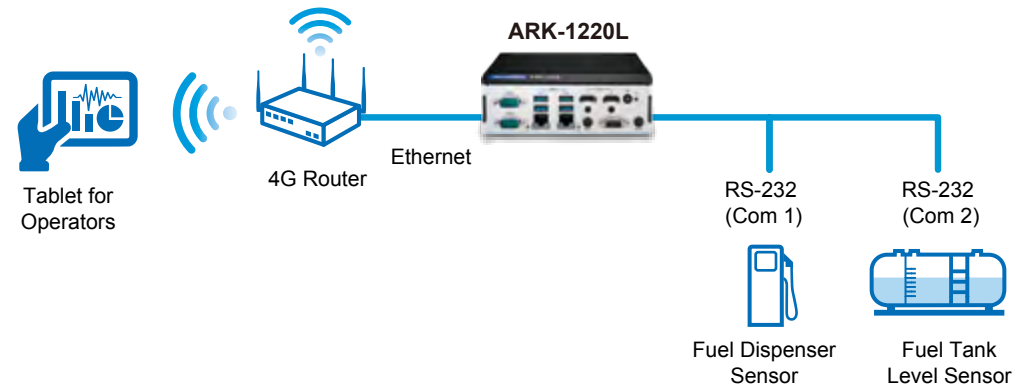



## Environmentally Friendly, Ultra Low-power Roadside Information Board

Advantech's wireless 26" ePaper solution has joined a selection of smart lighting applications in Kaohsiung, Taiwan. These innovative large format ePaper displays simultaneously convey traffic information and government announcements. Advantech's signage panels are installed in public spaces where they display emergency/public service announcements and directions. These excellent solutions are capable of performing in bright daylight without using extra power.

### Benefits:

- Easy cable-free installation
- Sunlight readable capabilities for outdoor applications
- Supports IEEE 802.11 ac/b/g/n, LTE Cat.1 and USB interfaces

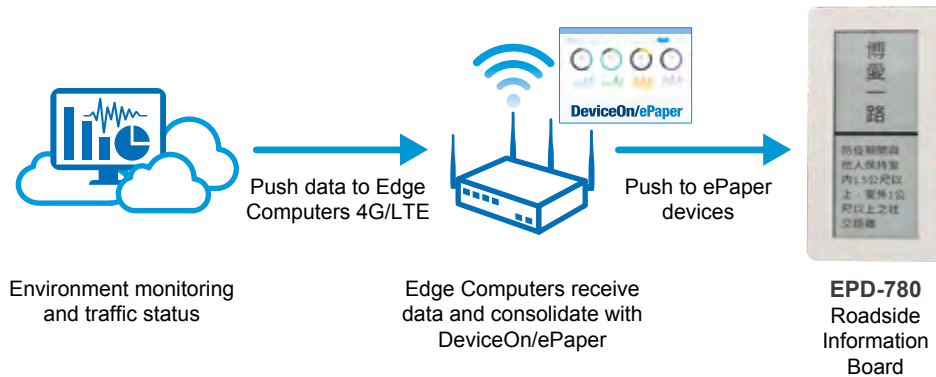

## AI Facial Recognition for School Pandemic Prevention and Containment

A Taiwanese system integrator specialized in school IT and surveillance system integration was developing AI-based epidemic prevention systems. Advantech Ei-A100 worked reliably to detect body temperatures and mask wearing. Following installation, the system was capable of sending the names of students with high body temperatures or without face masks to school staff using LINE push notifications. Advantech helped this SI overcome budgetary and technical challenges — creating a total AI-based facial recognition and thermal imaging solution for schools in Taiwan.

### Benefits:

- AI engine with 99.8% accuracy rate
- Built-in APIs quickly integrate with school management systems, student information databases, and LINE push notification systems
- High visual recognition performance via 2 x Intel® Movidius™ VPUs

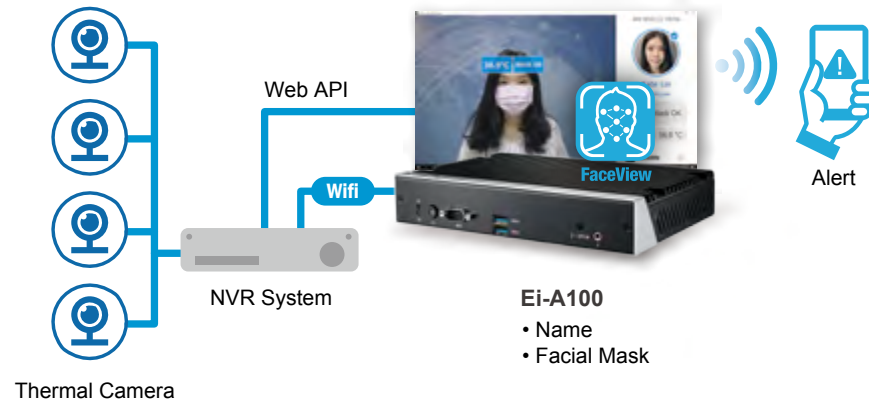
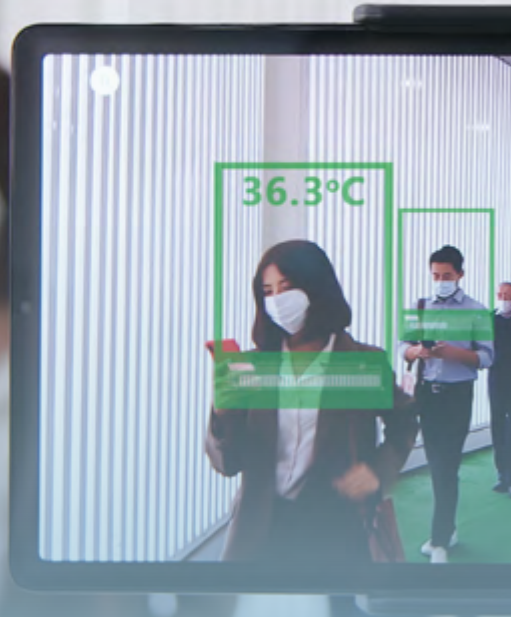

## AI-driven Video Surveillance and Monitoring for Home and Business Applications

Our customer provides efficient security-as-a-service solutions that combine AI and worker capabilities for homes and public buildings in Switzerland. The Advantech AIR-101 AI system features two Intel® AI Movidius™ VPU that help accurately identify people, animals, and cars entering or leaving the property using security cameras. Following identification, it sends instant alerts via email and SMS.

### Benefits:

- Built-in VPUs accelerate RTSP decoding for higher camera FPS and lower CPU load
- Preinstalled with Intel® OpenVINO™ toolkit for easy deployment
- Reliable, Fanless, industrial grade solution supports 24/7 operation

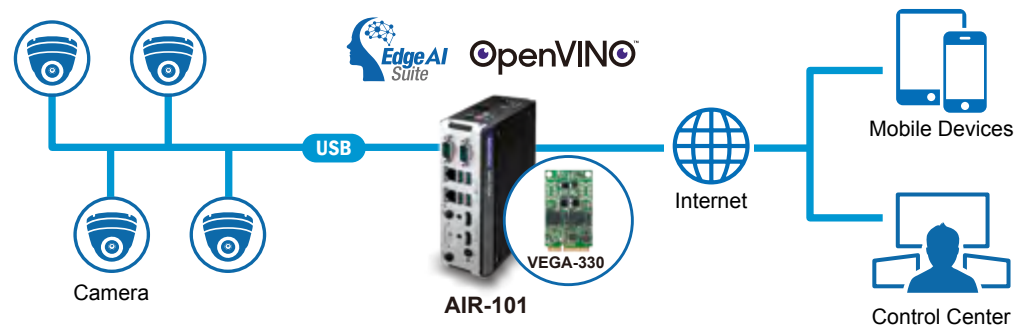

## Smart Building



Region South Korea

## Temperature Monitoring Solutions

AI and big data are being used to manage the spread of COVID-19. SQISOFT, a famous South Korean system integrator, has integrated digital signage players with facial recognition capabilities and an IR thermographic camera, yielding a kiosk system capable of measuring body temperatures from a distance. This system can also check for masks, disseminate advertisements, and notify up to 30 people simultaneously. This innovative system uses Advantech's DS-082 ultra-slim 4K digital signage player and UCAM-220TT IR thermographic camera.

### Benefits:

- Handling multi-task operations such as temperature checking and multimedia broadcasting
- Ultra slim design for easy installation
- Diverse I/O for connecting with a range of devices

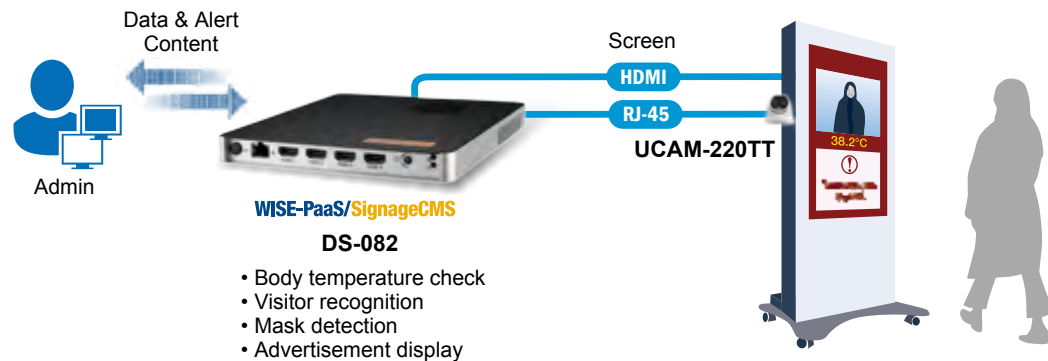

## Touchless AI Elevator System

The Covid-19 pandemic has increased demands for touchless technologies. The customer in this case is a smart building system integrator in Taiwan that installs AI facial recognition systems in elevators that enable touchless access control and prevent illness transmission. Advantech's EI-A100 AI facial recognition system recognizes the individuals using elevators and grants access to pre-specified floors. It sends automated alerts if it detects unauthorized access or if someone alights at an unauthorized floor.

### Benefits:

- Easy-to-use SDK for 2nd development and backend system integration
- Built-in Intel® Myriad™ X VPUs for AI acceleration and low power consumption
- High accuracy rate (TAR, True Acceptance Rate) of 99.7% at 10-4 FAR



## Remote Underground Coal Mine Safety Monitoring System

Mining takes place in dangerous, hostile environments. These conditions necessitate remote monitoring systems capable of detecting unsafe conditions and generating alarms. Advantech's ARK-2250L was used in this application. It was installed in an explosion proof enclosure situated inside a ground station and connected to different sensors. These sensors monitor working conditions within mines using cameras, thermometers, and humidity sensors. ARK-2250L collects this data wirelessly and compares it with predefined critical safety values. This enables working conditions to be displayed on a large screen in real-time while delivering emergency alerts to supervisors during gas leaks and other dangerous events.

### Benefits:

- Enables stable data transmission via 2 x Ethernet at 1000 Mbps
- High performance computing with wide operating temperature capabilities
- Fanless, compact design eases system integration

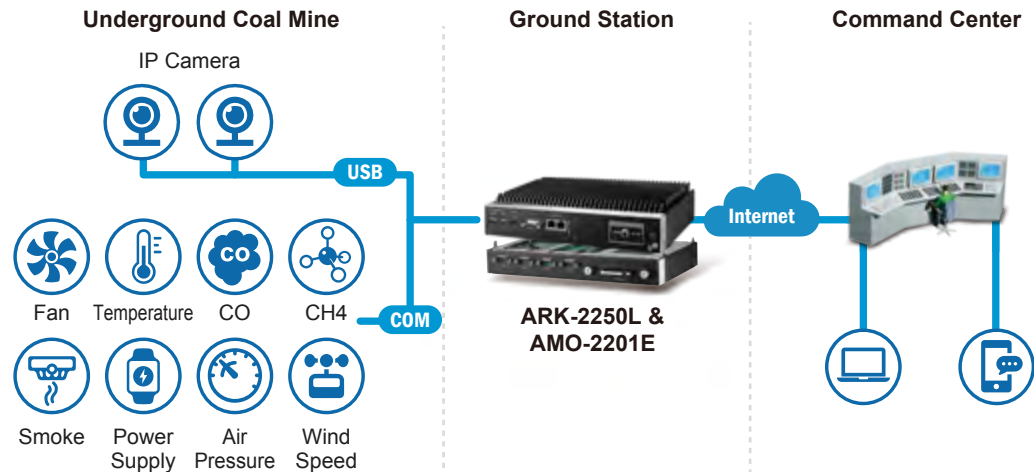

## Centralized Management Smart Energy Storage Systems

The Taiwanese battery manufacturer Amita Technologies Inc. has a factory in Taoyuan with an innovative energy storage system. This system uses a set of smart energy storage applications aimed at helping administrators effectively calculate factory power consumption. Using these calculations, managers can develop power usage strategies aimed at energy conservation. This power storage system — that utilizes Advantech’s smart IoT solution — will be promoted globally through Amita Technologies and Advantech’s extensive marketing resources. This power management system promotes environmental protection and sustainability within the global manufacturing industry.

### Benefits:

- Reduces the implementation barriers with hardware and software integrated solutions
- Remotely monitor and analyze power consumption in real time
- Reduced electricity costs by 15 ~ 20% by analyzing power usage during peak/off-peak hours

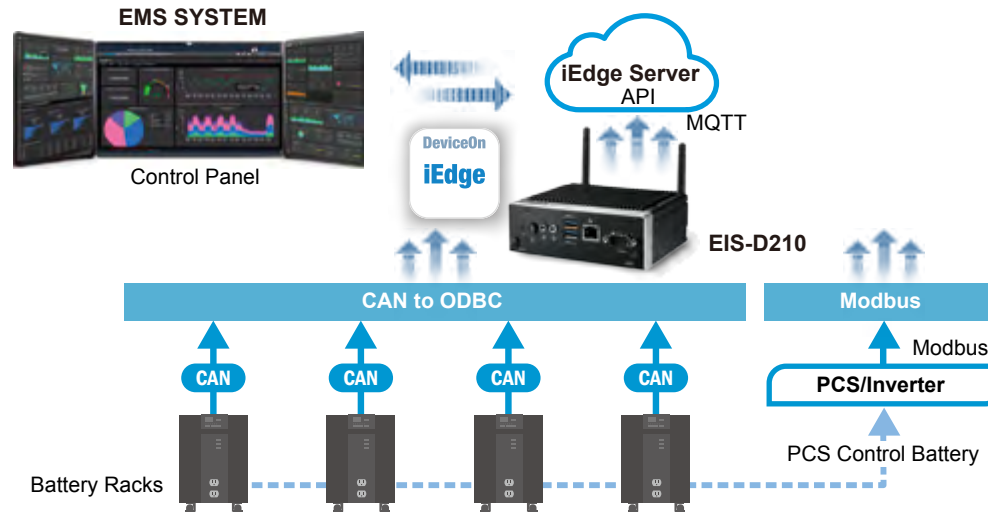

## Energy Storage System Monitoring and Control

Energy Storage Systems(ESS) play a fundamental role in helping with the intermittent nature of renewable energy produced by wind or solar power generation system and provide reliable supply of energy. An ESS provider in South Korea was building a high-density energy storage system that required an edge computer to achieve high energy efficiency and utilization. ARK-1220L was adopted to collect and monitor data such as charging and discharging current values and the temperature of each battery via Modbus protocols. Its fanless design, wide range of operating temperature and rapid heat dissipation capabilities, making it suitable for operation in harsh industrial environments.

### Benefits:

- Supports data collection via ADAM I/O modules and data transmission and communication via Wi-Fi/4G/LTE/Ethernet
- Rugged and fanless designs
- Compact and DIN-rail design for easy installation

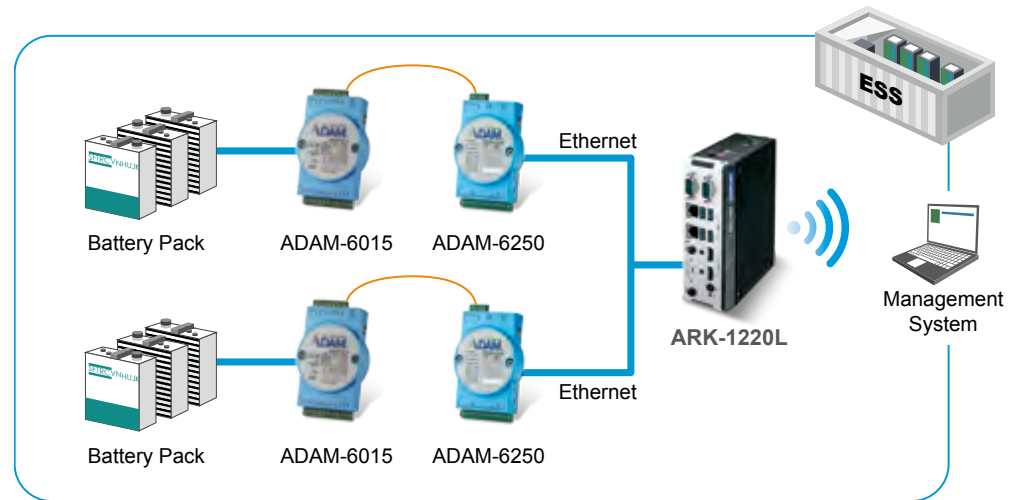



## Self-service Lockers Enable 24/7 Parcel Pickup

A leading global e-commerce company launched a network of self-service lockers in cities in the US, Europe, Mexico, Japan, and Canada. These lockers were used for parcel delivery and pick-up. Their complex development process necessitated an equally complex, multi-faceted system capable of synchronised operation. Advantech's ARK-2232L fanless controller PC met this application's needs using specific performance, security, and functionality standards.

### Benefits:

- Fanless, ruggedized design with multiple I/O — including USB, RS232, and dual display port
- BIOS customization services for specific I/O configuration requirements
- Includes robust security features — Trusted Platform Computing and Secure Boot etc.
- Local assembly and product care via Advantech's 13 worldwide regional service centers

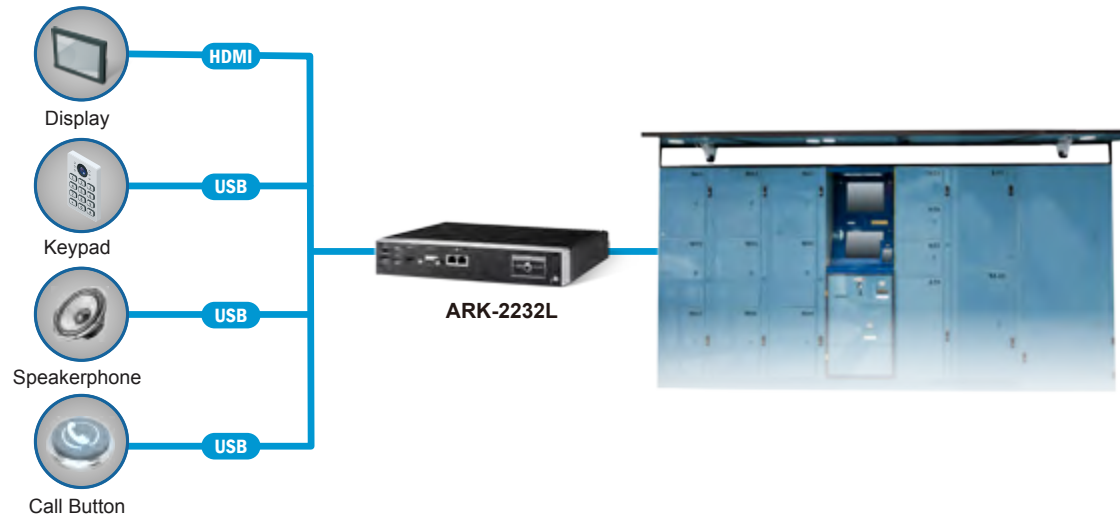

## Enhancing the Customer Experience with Self-Ordering Kiosk

As easy-access menus ensure prompt order processing at peak times, self-ordering kiosks are becoming more prevalent in quick service restaurants (QSR). Advantech's customer is a leading QSR brand, and an early adopter of digital ordering technology. This QSR planned to install self-ordering kiosks in hundreds of stores. As a point of sale, a kiosk should provide an intuitive interface that enables customers to order and pay securely. It should also enable customers to personalize menu items without the help of staff. Advantech provided a highly reliable turnkey digital signage solution with long life component support.

### Benefits:

- Multiple I/O for external devices — including touchscreens, card readers, and receipt printers etc.
- Customized BIOS images accommodate diverse software needs, reduce OS footprint, and increase storage capacity
- Ultra slim design eases cabinet integration

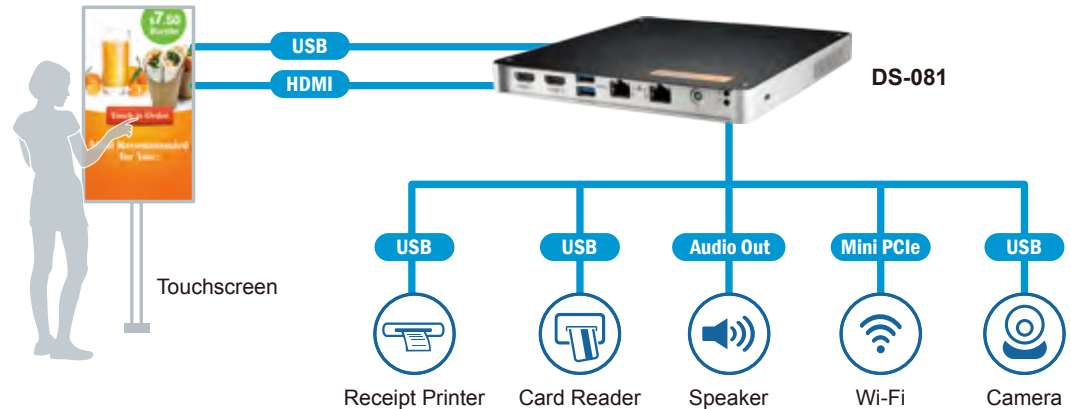

## Kiosk & Retail



Region UK

# Digital Signage Improves Experiences and Increases Sales

One of the UK's largest pharmacy/health and beauty chains was implementing an in-store digital signage system aimed at enhancing customer engagement and boosting sales. Advantech DS-082 digital signage solutions were placed near windows and along shelves to simultaneously present advertisements on several 4K displays. This DS-082 solution leverages powerful AMD V1000 CPUs to empower high-performance, cost-effective interactive/window signage, and video wall applications.

### Benefits:

- Support up to 4 x 4K UHD displays
- Slim 19 mm (.74 in) thick design eases installation
- Fanless design improves reliability

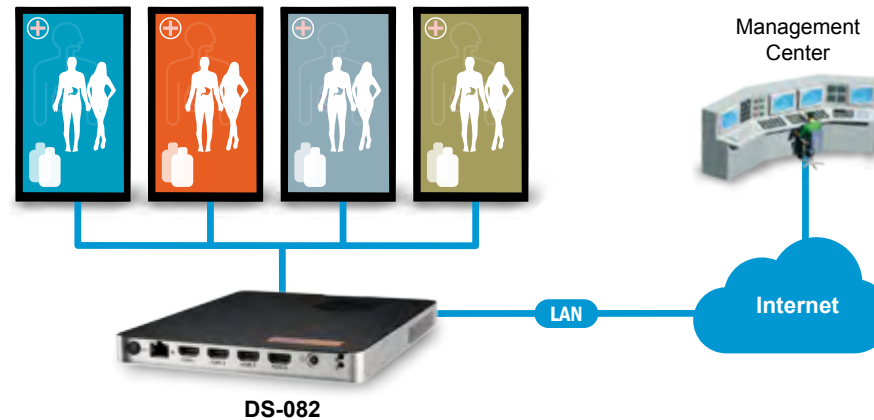

# Edge+ Solution High-lights



## Edge Intelligence Software and Cloud

WISE-DeviceOn improves management, enables real-time remote access, and facilitates efficient operation. It leverages the Cloud and integrated domain-focused application software



## AI Software and Inference

Empower AI at the edge and realize real-time intelligence in AGV/drones, defect inspection, traffic monitoring, and medical imaging applications



## Wireless Connectivity

Demystify AIoT and leverage 5G/Wi-Fi 6 to enjoy faster speeds, millisecond latency, and reduced network congestion

## Regional Service and Customization Centers

**China** | Kunshan  
86-512-5777-5666

**Taiwan** | Taipei  
886-2-2792-7818

**Netherlands** | Eindhoven  
31-40-267-7000

**Poland** | Warsaw  
00800-2426-8080

**USA** | Milpitas, CA  
1-408-519-3898

## Worldwide Offices

### Asia Pacific

#### Taiwan

Toll Free 0800-777-111  
Taipei & IoT Campus 886-2-2792-7818  
Taichung 886-4-2372-5058  
Kaohsiung 886-7-392-3600

#### China

Toll Free 800-810-0345  
Beijing 86-10-6298-4346  
Shanghai 86-21-3632-1616  
Shenzhen 86-755-8212-4222  
Chengdu 86-28-8545-0198  
Hong Kong 852-2720-5118

### Middle East and Africa

Israel 072-2410527  
Turkey 90-212-222-0422  
Turkey-Bursa 90-224-413-3134

### Asia Pacific

#### Japan

Toll Free 0800-500-1055  
Tokyo 81-3-6802-1021  
Osaka 81-6-6267-1887  
Nagoya 81-0800-500-1055  
Nogata 81-949-22-2890

#### Korea

Toll Free 080-363-9494/5  
Seoul 82-2-3660-9255

#### Singapore

Singapore 65-6442-1000

#### Malaysia

Kuala Lumpur 60-3-7725-4188  
Penang 60-4-537-9188

#### Thailand

Bangkok 66-02-2488306-9

#### Vietnam

Hanoi 84-24-3399-1155  
Hochiminh 84-28-3836-5856

#### Indonesia

Jakarta 62-21-751-1939

#### Australia

Toll Free 1300-308-531  
Melbourne 61-3-9797-0100

#### India

Bangalore 91-94-4839-7300  
Pune 91-94-2260-2349

### Europe

#### Netherlands

Eindhoven 31-40-267-7000  
Breda 31-76-523-3100

#### Germany

Toll Free 00800-2426-8080/81  
Munich 49-89-12599-0  
Düsseldorf 49-2103-97-855-0

#### France

Paris 33-1-4119-4666

#### Italy

Milan 39-02-9544-961

#### UK

Newcastle 44-0-191-262-4844  
London 44-0-870-493-1433

#### Spain

Madrid 34-91-668-86-76

#### Sweden

Stockholm 46-0-864-60-500

#### Poland

Warsaw 48-22-31-51-100

#### Russia

Moscow 8-800-555-01-50  
St. Petersburg 8-812-332-57-27  
8-921-575-13-59

#### Czech Republic

Ústí nad Orlicí 420-465-524-421

#### Ireland

Galway 353-91-792444

### Americas

#### North America

Toll Free 1-888-576-9668  
Cincinnati 1-513-742-8895  
Milpitas 1-408-519-3898  
Irvine 1-949-420-2500  
Ottawa 1-815-433-5100  
Chicago 1-888-576-9668

#### Brazil

Toll Free 0800-770-5355  
São Paulo 55-11-5592-5367

#### Mexico

Toll Free 1-800-467-2415  
Mexico City 52-55-6275-2777