

Gigabit Media Converter Module

 perle.com/products/gigabit-managed-media-converter-module.shtml

Managed



- 1000Base-T to 1000Base-X Fiber Media Converters
- Extend network distances up to 160km
- Advanced features - Smart Link Pass-Through, Fiber Fault Alert, Auto-MDIX and Loopback
- High density applications with Perle [Media Converter Chassis](#)
- Manage via SNMP, CLI - Telnet/SSH, Internet browser, or [PerleVIEW Centralized Management Package](#) with an [MCR-MGT Media Converter Management Module](#)

Installed in a high density [Perle Media Converter Chassis](#), Perle's line of feature rich **Managed Gigabit Media Converter Modules** transparently connect copper to fiber. Our Gigabit Ethernet to Fiber Converters provide an economical path to extend the distance of an existing network, the life of non-fiber based equipment, or the distance between two devices.

Network Administrators can "see-everything" with Perle's advanced features such as Auto-Negotiation, Auto-MDIX, Link Pass-Through, Fiber Fault Alert, and Loopback. Along with a [Media Converter Management Module](#) in the chassis, configuration and monitoring of the copper and fiber ports can be performed. This allows for more efficient troubleshooting and less on-site maintenance. These cost and time saving features, along with a lifetime warranty and free worldwide technical support, make **Perle's managed gigabit ethernet converter modules** the smart choice for IT professionals.

For those environments requiring a medium to large-scale deployment of media converters, a centralized platform that simplifies the configuration, administration, monitoring, and troubleshooting of this gear is recommended. [PerleVIEW Device Management](#) software is a multi-user, Windows server-based application that delivers this level of Enterprise-grade solution.

CM-1000 Managed Media Converter Features

Configuration Mode selection Select whether the module is to use the on-board DIP switches or enable the management module in the chassis to manage

Module Information

- Chassis Slot number that the module is in
 - Media converter model and serial
 - User configurable module name
 - User configurable fiber port name
 - User configurable copper port name
 - Hardware revision number
 - Firmware version number
-

Module DIP switch settings	View hardware DIP switch settings
Low power mode	If enabled it sets the Gigabit copper transceiver into “low power mode” which limits the strength of the signal. (for shorter cable lengths). Default is disabled
Port Control	Enable or disable individual fiber or copper port on the module
Copper Port Status	<ul style="list-style-type: none"> • Port Enabled (Yes/No) • Link Status (Up/Down) • Auto Negotiation Settings (Disabled, Complete or In Progress) • Resolved as crossover MDI or MDIX type
Fiber Port Status	<ul style="list-style-type: none"> • Port Enabled (Yes/No) • Connector type (SC, LC, ST, SFP) • Link Status (Up/Down) • Far End Fault (OK, Failed) • Fiber Loopback mode (On/Off)
Module Control	<ul style="list-style-type: none"> • Reset card • Reset to factory default • Ability to specific read/write phy registers. • Update firmware • Fiber Loopback mode (Yes/No) • Upload/download configuration
Backup and Restore	Provides fast and easy module replacement. Management module will always save a copy of the media converter configuration and will restore this configuration automatically to the media module when it is detected in the slot
Auto-Negotiation (802.3ab)	<p>The media converter supports auto negotiation. The 1000Base-X fiber interface negotiates according to 802.3 clause 37. The 1000Base-T negotiates according to 802.3 clause 28 and 40. The 1000Base-X will link up with its partner after the highest common denominator (HCD) is reached and the copper has linked up with its partner. The 1000Base-X will continue to cycle through negotiation transmitting a remote fault of offline (provided this is enabled through the switch setting) until the copper is linked up and the HCDs match.</p> <p>The media converter supports auto-negotiation of full duplex, half duplex, remote fault, full duplex pause, asymmetric pause and Auto MDI-X.</p>
Auto-MDIX with Skew Correction	<p>Auto-MDIX (automatic medium-dependant interface crossover) detects the signaling on the 1000Base-T interface to determine the type of cable connected (straight-through or crossover) and automatically configures the connection when enabled. The media converter can also correct for wires swapped within a pair.</p> <p>The media converter will adjust for up to 64ns of delay skew between the 1000Base-T pairs.</p>
Smart Link Pass-Through	When the Link Mode switch is placed into Smart Link Pass-Through mode, the 1000Base-T port will reflect the state of the 1000Base-X media converter port. This feature can be used whether fiber auto-negotiation is enabled or disabled.
Fiber Fault Alert	With Fiber Fault Alert the state of the 1000Base-X receiver is passed to the 1000Base-X transmitter. This provides fault notification to the partner device attached to the 1000Base-X interface of the media converter. If the 1000Base-X transmitter is off as a result of this fault it will be turned on periodically to allow the condition to clear should the partner device on the 1000Base-X be using a similar technique. This eliminates the possibility of lockouts that occur with some media converters. Applies only when fiber auto-negotiation is disabled.

Pause (IEEE 802.3x)	Pause signaling is an IEEE feature that temporarily suspends data transmission between two devices in the event that one of the devices becomes overwhelmed. The media converter supports pause negotiation on the 1000Base-T fiber connection and 1000Base-X fiber connection. Select Symmetrical, asymmetrical TX or asymmetrical RX
Duplex	Full and half duplex operation supported.
Jumbo Packets	Transparent to jumbo packets up to 10KB-default. Jumbo packet support can be disabled.
VLAN	Transparent to VLAN tagged packets. Default Jumbo packet can be disabled.
Remote Loopback	Capable of performing a loopback on the 1000Base-X fiber interface.

Indicators

Power / TST	This green LED is turned on when power is applied to the media converter. Otherwise it is off. The LED will blink when in Loopback test mode.
Fiber link on / Receive activity (LKF)	This green LED is operational only when power is applied. The LED is on when the 1000Base-X link is on and flashes with a 50% duty cycle when data is received. The LED will slow blink when the 1000Base-X interface has been taken down as a result of a fault on the 1000Base-T interface.
Copper link on / Receive activity (LKC)	This green LED is operational only when power is applied. The LED is on when the 1000Base-T link is on and flashes with a 50% duty cycle when data is received. The LED will slow blink when the 1000Base-T interface has been taken down as a result of a fault on the 1000Base-T interface.

Switches: On-Board (If Auto/Switch strap is set to Switch)

Auto-Negotiation	<p><i>Enabled (Default - Up)</i> - In this mode the 1000Base-X and the 1000Base-T will negotiate to the HCD of the two link partners. The 1000Base-X will link up after the negotiation is completed and the 1000Base-T has linked up.</p> <p><i>Disabled</i> - The 1000Base-X will not use auto negotiation. The 1000Base-T will negotiate to the HCD of the Switch settings and the link partner.</p>
Link Mode	<p>Link Mode provides a transparency to the state of the copper link allowing for simplified trouble shooting from the devices connected to the media converter.</p> <p><i>Normal (Default - Up)</i> With Fiber Auto Negotiation enabled when the 1000Base-T link goes down the 1000Base-X link is brought down. The 1000Base-X link will advertise Remote Fault (Link Fault).</p> <p>With Fiber Auto Negotiation disabled the state of the 1000Base-T link has no effect on the 1000Base-X link.</p> <p><i>Smart Link Pass Through (Down)</i> With Fiber Auto Negotiation enabled the behavior is as follows. When the 1000Base-T link goes down the 1000Base-X link is brought down. The 1000Base-X link will advertise Remote Fault (Link Fault). When Remote Fault (Link Fault) is received on the 1000Base-X interface the 1000Base-T transmitter will be turned off. When the 1000Base-T receiver is off the 1000Base-X transmitter will be turned off. When the 1000Base-X receiver goes off the 1000Base-T transmitter will be turned off.</p> <p>With Fiber Auto-Negotiation disabled the behavior is as follows. When the 1000Base-T receiver is off the 1000Base-X transmitter will be turned off. When the 1000Base-X receiver goes off the 1000Base-T transmitter will be turned off.</p>

Pause	<p>When Fiber Auto Negotiation is disabled Pause should only be enabled when all devices connected to the media converter support pause.</p> <p><i>Enabled(Default)</i> - The Media converter will advertise Pause capable, Asymmetric pause not needed during Auto-Negotiation.</p> <p><i>Disabled</i> - The Media converter will advertise that it does not have Pause capability during Auto-Negotiation.</p>
Fiber Fault Alert	<p>The Fiber Fault Alert switch has meaning when Auto-Negotiation is disabled</p> <p><i>Enabled (Default - Up)</i> When the 1000Base-X receiver is off the 1000Base-X transmitter is turned off. Periodically the 1000Base-X receiver will be turned on for a short period to allow the condition to clear if the 1000Base-X link partner is using a similar feature.</p> <p><i>Disabled (Down)</i></p>
Duplex	<p><i>Full (Default-Up)</i> - The media converter will advertise Full Duplex Capable, Half Duplex Capable.</p> <p><i>AUTO (Down)</i> -The Media converter will advertise Full Duplex Not Capable, Half Duplex Capable.</p>
Remote Loopback	<p>The media converter can perform a loopback on the 1000Base-X fiber interface.</p> <p><i>Disabled (Default - Up)</i></p> <p><i>Enabled</i> - The 1000Base-X receiver is looped to the 1000Base-X transmitter. The 1000Base-T transmitter is taken off the interface.</p>
Configuration Mode Strap	Auto (default) enable management module to overwrite hardware switch settings Switch - Use on-board DIP switches

Connectors

1000Base-T	RJ45 connector, 4 pair CAT 5 UTP cable or cable
Magnetic Isolation	1.5kv

Packet Transmission Characteristics

Bit Error Rate (BER)	<10 ⁻¹²
----------------------	--------------------

Environmental Specifications

Operating Temperature	0° C to 50° C (32° F to 122° F)
Storage Temperature	minimum range of -25° C to 70° C (-13° F to 158° F)
Operating Humidity	5% to 90% non-condensing
Storage Humidity	5% to 95% non-condensing
Operating Altitude	Up to 3,048 meters (10,000 feet)
Heat Output (BTU/HR)	10.2

Maximum Power Consumption (Watts)	3.0
MTBF (Hours)*	609,000
Mechanical - Hot Swapping Card	
Edge Connector	32 pin DIN 41612 / IEC 60603-2 Type B/2 Male. First make, last break for ground and power
Card insertion and removal	Captive thumb screws enable fast insertion and removal. Can be further tightened with a screwdriver.
Product Weight	
Weight	0.15 kg, 0.33 lbs
Packaging	
Shipping Weight	0.33 kg, .73 lbs
Shipping Dimensions	203 x 38 x 152 mm, 8 x 1.5 x 6 inches
Regulatory Approvals	
Emissions	FCC Part 15 Class A, EN55022 Class A CISPR 22 Class A EN61000-3-2
Immunity	EN55024
Electrical Safety	UL 60950-1 EN60950 CE
Laser Safety	EN 60825-1:2007 Fiber optic transmitters on this device meet Class 1 Laser safety requirements per IEC-60825 FDA/CDRH standards and comply with 21CFR1040.10 and 21CFR1040.11.
Environmental	Reach, RoHS and WEEE Compliant
Other	ECCN: 5A991 HTSUS Number: 8517.62.0050 Perle Limited Lifetime Warranty

*Calculation model based on MIL-HDBK-217-FN2 @ 30 °C

High Density Fiber Distribution from UTP Switch Equipment at Corporate Headquarters

In this enterprise campus application, up to 18 Perle CM-1000 Gigabit to Fiber Media Converters are installed in the MCR1900 Media Converter Chassis. The 19th slot in the chassis is filled the MCR-MGT Management Module. All media converts in the chassis are managed by SNMP, Telnet or an internet browser interface. A remote fiber enabled Ethernet switch is connected directly to the central MCR1900 Chassis. A standalone S-1000 Media Converter converts the fiber to Ethernet in a fiber-to-desktop application. Another S-1000 Fiber Media Converter is connected to a remote office Ethernet switch. In all cases, multimode or single-mode fiber can be used. Fiber links can be extended up to 120km using single-mode fiber.

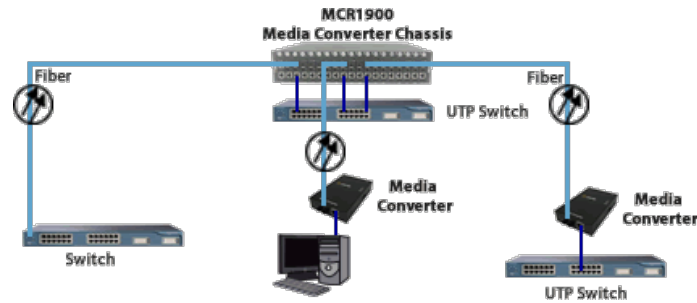

Ethernet to Fiber in a Campus Network

The use of chassis-based media converters is a cost effective means in providing fiber connectivity in a campus network. By consolidating Ethernet to fiber conversion in a rack mount media converter chassis, various types of fiber links can be brought into a single wiring closet platform. This simplifies deployment and maintenance and also provides a scalable means to grow your network as needed.

Managed Media Converter Platform

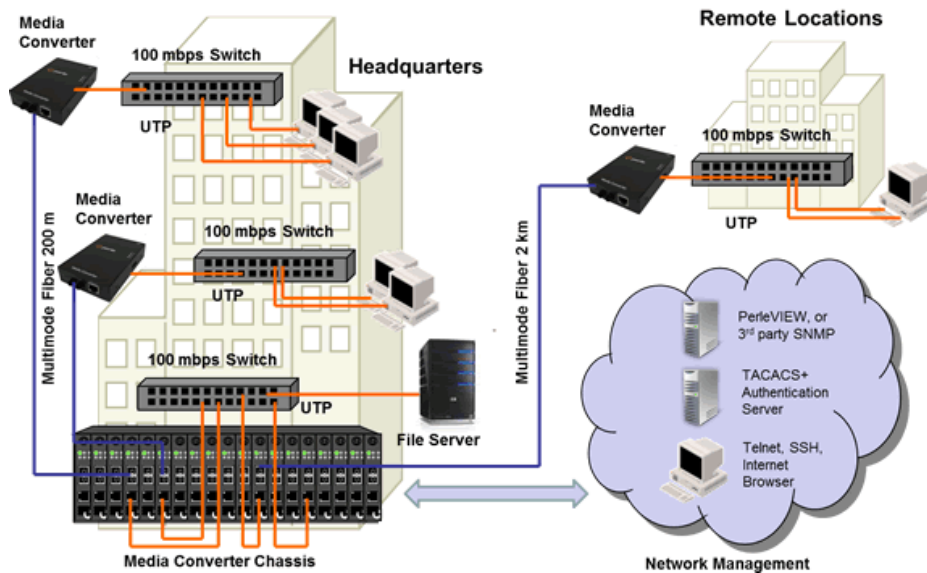

Managed Ethernet over Fiber Links

Manage your **copper to fiber** link with an MCR200 chassis housing a media converter and management module. Ideal for use in managed networks with low density fiber applications, this Managed Media Converter is connected across a fiber link to a remote media converter. The copper or fiber link on the managed standalone unit can provide vital information and status to network management tools such as SNMP.

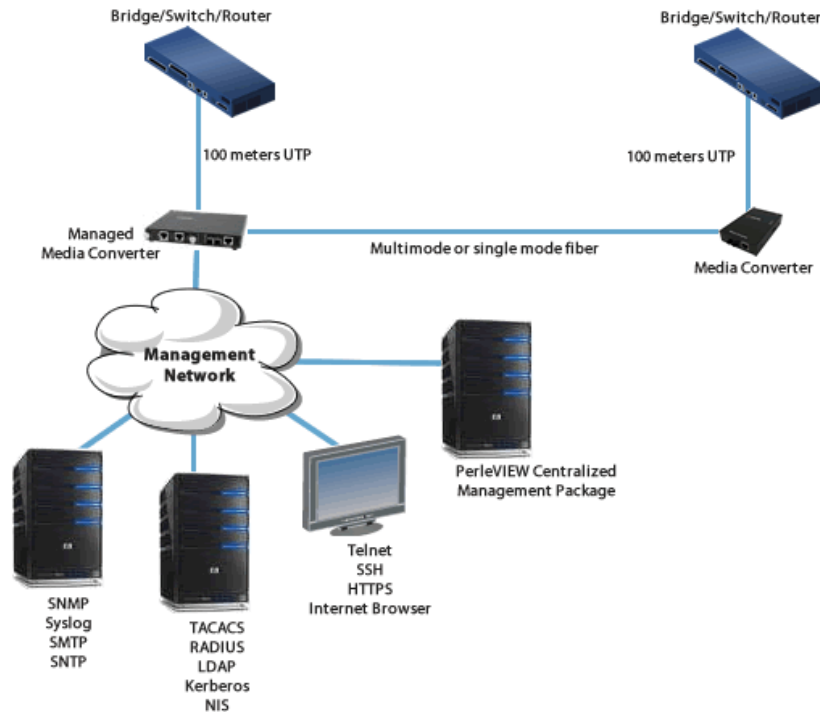

Extend between two TP Gigabit Switches

Extend the network distance between two twisted pair Gigabit Switches

Two Gigabit Ethernet Media Converters can extend the distance between 1000Base-T Switches across a fiber link up to 120Km in length.

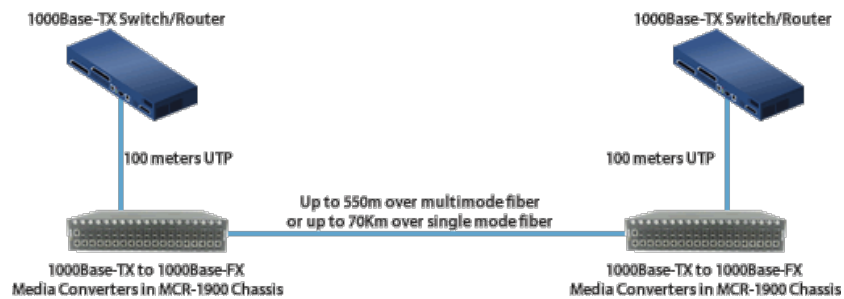

Switch to Gigabit Server

Extend the network distance between a Gigabit Switch and a Gigabit File Server

Two Gigabit Ethernet Media Converters can extend the distance between a 1000Base-T Switch and a Gigabit File Server across a fiber link up to 120Km in length.

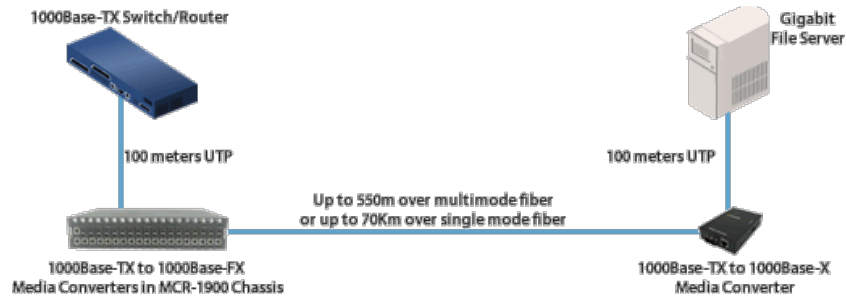

Gigabit Mode-Conditioning Adapters - More Distance

Extend Gigabit to 550m over 62.5 micron Multimode Fiber

Gigabit across 62.5 micron MMF cable is normally limited to 275 meters. By adding mode-conditioning adapters and 1000baseLX media converters you can extend the distance up to 550 meters on MMF cable plant.

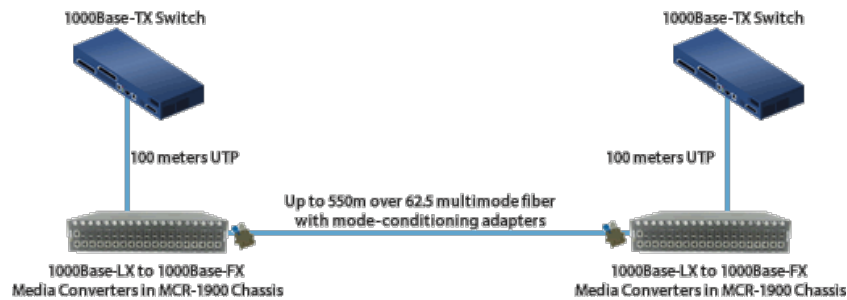

Gigabit Mode-Conditioning Adapters – 1000Base-LX

Installing Gigabit 1000Base-LX routers and switches into existing multimode cable plants

Using mode-conditioning adapters and a 1000Base-LX media converter, connect a copper based Gigabit Switch with a remote 1000base-LX switch/router over existing multimode cable plant.

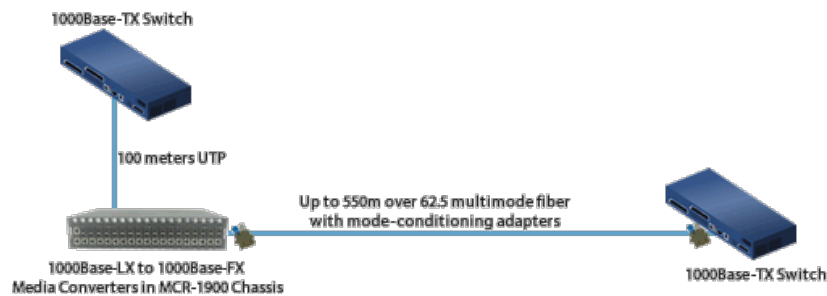

Fast Ethernet UTP Switch to File Server

Extend the network distance between switches and file servers

Two Fast Ethernet Media Converters can extend the distance between UTP Switches and remote file servers across fiber links up to 120km in length.

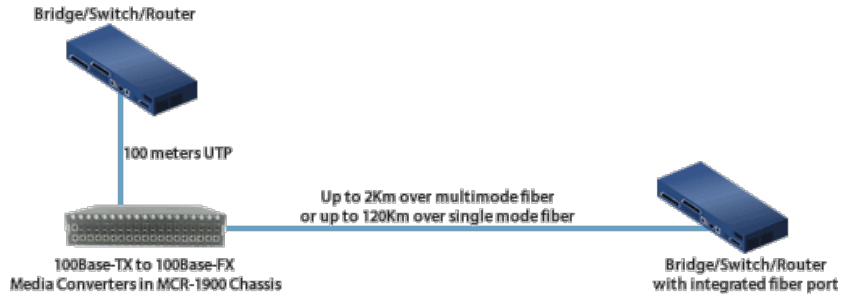

Enterprise Infrastructure

Enterprise Infrastructure using Fiber Optics

Create a fiber infrastructure for your enterprise network without any wholesale replacement of existing copper-based equipment.

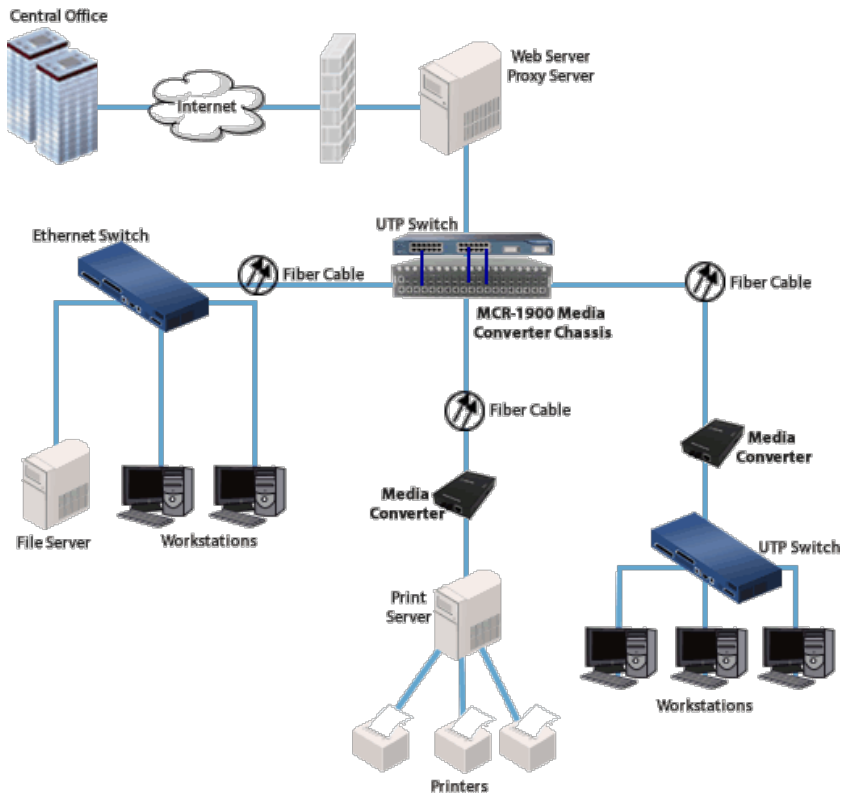

Single Mode / Single Fiber

Connect copper ports over a single fiber strand (also referred to as “Bi-Directional” BiDi)

When Single Strand fiber is used, a pair of Single Fiber Media Converters is needed for the copper to fiber conversion. Perle Single Fiber Media Converters are also referred to as “Up/Down” models. For example the CM-1000-S1SC10U (“Up”) and CM-1000-S1SC10D (“Down”), shown below, must be used in pairs. An “Up” must be matched with a “Down” peer to deal with transmit and receive frequencies separately.

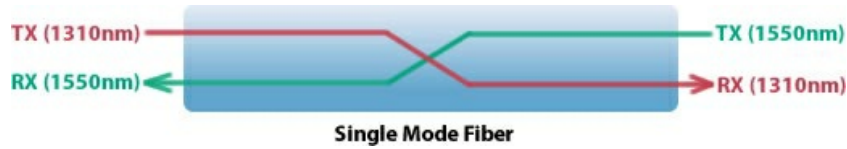

CM-1000-S1SC10UCM-1000-S1SC10D

The majority of installations for single mode fiber media converters are of the “dual connector” or “dual fiber” type where one fiber connection is used for transmit, the other for receive. These are physically “crossed” to match up the Transmit/Receive links.

However, to reduce costs, or where there are limits on available fiber, WDM technology may be utilized. WDM uses separate transmit and receive frequencies to communicate on a single fiber strand. WDM technology relies on the fact that optical fibers can carry many wavelengths of light simultaneously without interaction between each wavelength. Thus, a single fiber can carry many separate wavelength signals or channels simultaneously.

So remember, if Single Strand fiber is used, you will need an “Up” Media Converter on one side and a “Down” Media Converter on the other for copper to fiber conversion.

Perle offers a wide variety of Single Fiber (“Up/Down”) Media Converters to connect 10BaseT, Fast Ethernet and Gigabit to single fiber. Whether you need Managed or Unmanaged, Standalone or Modular Chassis Based, 20km or 120km, Perle has the right model to meet your fiber conversion requirement.

Select a Model to obtain a Part Number - Managed Media Converter Chassis Modules - Gigabit Ethernet to Fiber

Model	Connector	Type	Transmit (dBm)		Receive (dBm)		Power Budget (dBm)	Wavelength (nm)	Fiber Type	Core Size (um)	Modal Bandwidth (MHz* Km)	Operating Distance
			Min	Max	Min	Max						
CM-1000-M2SC05	Dual SC	1000Base-SX	-9.5	-4.0	-	-3.0	7.5	850	MMF	62.5	160	220 m (722 ft)
					17.0							275 m (902 ft)
												500 m (1,640 ft)
												550 m (1,804 ft)
												1000 m (3281 ft)
CM-1000-M2LC05	Dual LC	1000Base-SX	-9.5	-4.0	-	-3.0	7.5	850	MMF	62.5	160	220 m (722 ft)
					17.0							275 m (902 ft)
												500 m (1,640 ft)
												550 m (1,804 ft)

											50	2000	1000 m (3281 ft)
CM-1000-M2ST05	Dual ST	1000Base-SX	-9.5	-4.0	-17.0	-3.0	7.5	850	MMF	62.5	160	220 m (722 ft)	
										62.5	200	275 m (902 ft)	
										50	400	500 m (1,640 ft)	
										50	500	550 m (1,804 ft)	
										50	2000	1000 m (3281 ft)	
CM-1000-M2SC2	Dual SC	1000Base-LX	-6.0	0.0	-17.0	-0.0	11	1310	MMF	62.5	160	2 km (1.2 mi)	
										50	500	1000m (3280ft)	
CM-1000-M2ST2	Dual ST	1000Base-LX	-6.0	0.0	-17.0	-0.0	11	1310	MMF	62.5	160	2 km (1.2 mi)	
										50	500	1000m (3280ft)	
CM-1000-M2LC2	Dual LC	1000Base-LX	-9.0	-1.0	-19.0	-1.0	10	1310	MMF	62.5	160	2 km (1.2 mi)	
										50	500	1000m (3280ft)	
CM-1000-S2SC10	Dual SC	1000Base-LX/LH	-9.5	-3.0	-20.0	-3.0	10.5	1310	MMF*	62.5	500	550 m (1,804 ft)	
										50	400	550 m (1,804 ft)	
										50	500	550 m (1,804 ft)	
									SMF	**	-	10 km (6.2 mi)	
CM-1000-S2LC10	Dual LC	1000Base-LX/LH	-9.5	-3.0	-20.0	-3.0	10.5	1310	MMF*	62.5	500	550 m (1,804 ft)	
										50	400	550 m (1,804 ft)	
										50	500	550 m (1,804 ft)	
									SMF	**	-	10 km (6.2 mi)	
CM-1000-S2ST10	Dual ST	1000Base-LX/LH	-9.5	-3.0	-20.0	-3.0	10.5	1310	MMF*	62.5	500	550 m (1,804 ft)	
										50	400	550 m (1,804 ft)	

										50	500	550 m (1,804 ft)	
										SMF	**	-	10 km (6.2 mi)
CM-1000-S2SC40	Dual SC	1000Base-EX	-2.0	2.0	-23.0	-3.0	21.0	1310	SMF	**	-	40 km (25 mi)	
CM-1000-S2LC40	Dual LC	1000Base-EX	-3.0	2.0	-23.0	-3.0	20.0	1310	SMF	**	-	40 km (25 mi)	
CM-1000-S2ST40	Dual ST	1000Base-EX	-2.0	2.0	-23.0	-3.0	21.0	1310	SMF	**	-	40 km (25 mi)	
CM-1000-S2SC70	Dual SC	1000Base-ZX	-2.0	5.0	-23.0	-3.0	21.0	1550	SMF	-	-	70 km (43 mi)	
CM-1000-S2LC70	Dual LC	1000Base-ZX	0.0	5.0	-23.0	-3.0	23.0	1550	SMF	-	-	70 km (43 mi)	
CM-1000-S2ST70	Dual ST	1000Base-ZX	-2.0	5.0	-23.0	-3.0	21.0	1550	SMF	-	-	70 km (43 mi)	
CM-1000-S2SC120	Dual SC	1000Base-ZX	0.0	5.0	-32.0	-9.0	32	1550	SMF	-	-	120 km (75 mi)	
CM-1000-S2LC120	Dual LC	1000Base-ZX	0.0	5.0	-32.0	-9.0	32	1550	SMF	-	-	120 km (75 mi)	
CM-1000-S2ST120	Dual ST	1000Base-ZX	0.0	5.0	-32.0	-9.0	32	1550	SMF	-	-	120 km (75 mi)	
CM-1000-S2SC160	Dual SC	1000Base-ZX	2.0	5.0	-34.0	-9.0	36	1550	SMF	-	-	160 km (100 mi)	
CM-1000-S2LC160	Dual LC	1000Base-ZX	2.0	5.0	-34.0	-9.0	36	1550	SMF	-	-	160 km (100 mi)	
CM-1000-S2ST160	Dual ST	1000Base-ZX	2.0	5.0	-34.0	-9.0	36	1550	SMF	-	-	160 km (100 mi)	

Single Fiber Models (Recommended use in pairs)

Model	Connector	Type	Transmit (dBm)		Receive (dBm)		Power Budget (dBm)	Wavelength (nm)	Fiber Type	Core Size (um)	Modal Bandwidth (MHz* Km)	Operating Distance
			Min	Max	Min	Max						
CM-1000-M1SC05U	Single SC	1000Base-BX-U	-	-4.0	-	-3.0	7.0	1310 / 1550	MMF	62.5	500	500 m (1,640 ft)
			10.0		17.0					50	500	500 m (1,640 ft)
CM-1000-M1SC05D	Single SC	1000Base-BX-D	-	-4.0	-	-3.0	7.0	1550 / 1310	MMF	62.5	500	500 m (1,640 ft)
			10.0		17.0					50	500	500 m (1,640 ft)
CM-1000-S1SC10U	Single SC	1000Base-BX-U	-9.0	-3.0	-20.0	-3.0	11.0	1310 / 1490	SMF	**	-	10 km (6.2 mi)
CM-1000-S1SC10D	Single SC	1000Base-BX-D	-9.0	-3.0	-20.0	-3.0	11.0	1490 / 1310	SMF	**	-	10 km (6.2 mi)

CM-1000-S1SC20U	Single SC	1000Base-BX-U	-8.0	-3.0	-22.0	-3.0	14.0	1310 / 1490	SMF	**	-	20 km (12.4 mi)
CM-1000-S1SC20D	Single SC	1000Base-BX-D	-8.0	-3.0	-22.0	-3.0	14.0	1490 / 1310	SMF	**	-	20 km (12.4 mi)
CM-1000-S1SC40U	Single SC	1000Base-BX-U	-3.0	2.0	-23.0	-3.0	20.0	1310 / 1490	SMF	**	-	40 km (25 mi)
CM-1000-S1SC40D	Single SC	1000Base-BX-D	-3.0	2.0	-23.0	-3.0	20.0	1490 / 1310	SMF	**	-	40 km (25 mi)
CM-1000-S1SC80U	Single SC	1000Base-BX-U	-2.0	3.0	-26.0	-3.0	24.0	1510 / 1590	SMF	-	-	80 km (50 mi)
CM-1000-S1SC80D	Single SC	1000Base-BX-D	-2.0	3.0	-26.0	-3.0	24.0	1590 / 1510	SMF	-	-	80 km (50 mi)
CM-1000-S1SC120U	Single SC	1000Base-BX-U	-3.0	2.0	-34.0	-9.0	31	1510 / 1590	SMF	-	-	120 km (75 mi)
CM-1000-S1SC120D	Single SC	1000Base-BX-D	-3.0	2.0	-34.0	-9.0	31	1590 / 1510	SMF	-	-	120 km (75 mi)

The minimum fiber cable distance for all converters listed is 2 meters.

*A mode-conditioning adapter as specified by the IEEE standard, is required regardless of the span length. Note how the mode conditioning adapter for 62.5-um fibers has a different specification from the mode-conditioning adapter for 50-um fibers.

**ITU-T G.652 SMF as specified by the IEEE 802.3z standard.

Media Converter Accessories

MCA1000-62SC	Mode Conditioning Adapter - Gigabit. IEEE 802.3z-compliant, consisting of a single-mode fiber permanently coupled off-center to a 62.5-micron multimode optical fiber with duplex SC connectors at both ends.
------------------------------	---